

**SPEED BIRD**  
ENTERPRISES

[www.birddent.com](http://www.birddent.com)

**ORAL MAXILLO FACIAL SURGERY INSTRUMENTS**

**SECTION**

**25**

# Oral Maxillo Facial Surgery

Elevators, Graft Packers  
Aufzüge, Graft Packers

Ascenseurs, Packers greffon  
Ascensores, Packers injerto



SB-3683-11  
11 cm / 4 <sup>3</sup>/<sub>4</sub>"



**Terry**



SB-3684-17  
6.0 / 8.0 mm

**Terry**  
17 cm / 6 <sup>3</sup>/<sub>4</sub>"

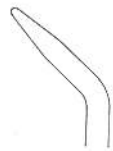

SB-3685-13  
13 cm / 6"



SB-3686-18  
3.5 / 7.0 mm

**Terry**  
18 cm / 7"



## Oral Maxillo Facial Surgery

Sinus Lift Currettes  
Sinus Lift Küretten

Currettes Sinus Lift  
Sinus Lift Curetas



SB-3687-01  
18 cm / 7"  
2.6 / 2.6 mm



SB-3687-02  
17.5 cm / 7"  
2.5 / 2.5 mm



SB-3687-03  
17.5 cm / 7"  
2.5 / 2.5 mm



SB-3687-04  
18.5 cm / 7 1/4"  
2.5 / 2.5 mm



SB-3687-05  
19 cm / 7 1/2"  
2.5 / 2.5 mm



SB-3687-06  
18.5 cm / 7 1/4"  
6.7 / 6.7 mm



SB-3687-07  
16 cm / 6 1/4"  
2.8 / 6.2 mm



SB-3687-08  
16 cm / 6 1/4"  
2.8 / 6.2 mm



SB-3687-09  
15 cm / 6"  
3.1 / 3.1 mm



SB-3687-10  
17 cm / 6 3/4"  
5.5 / 5.5 mm

# Oral Maxillo Facial Surgery

Sinus Lift Currettes  
Sinus Lift Küretten

Currettes Sinus Lift  
Sinus Lift Curetas

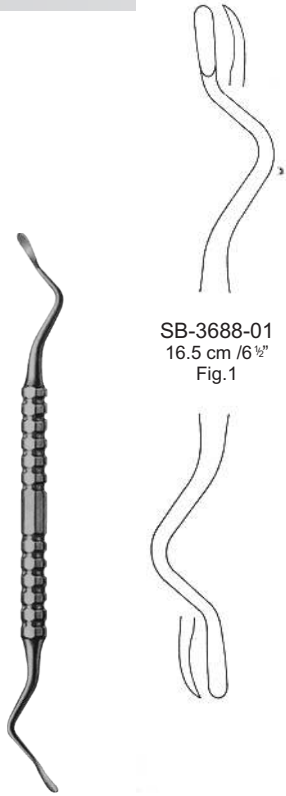

SB-3688-01  
16.5 cm / 6 1/2"  
Fig.1

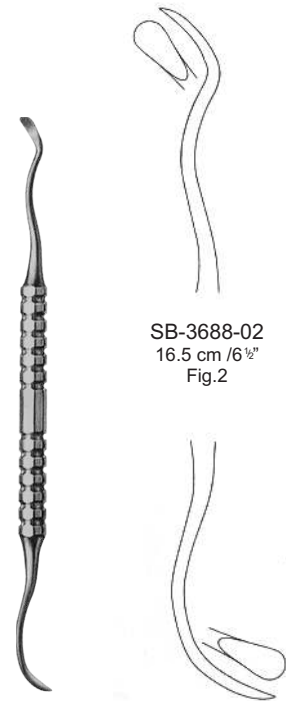

SB-3688-02  
16.5 cm / 6 1/2"  
Fig.2

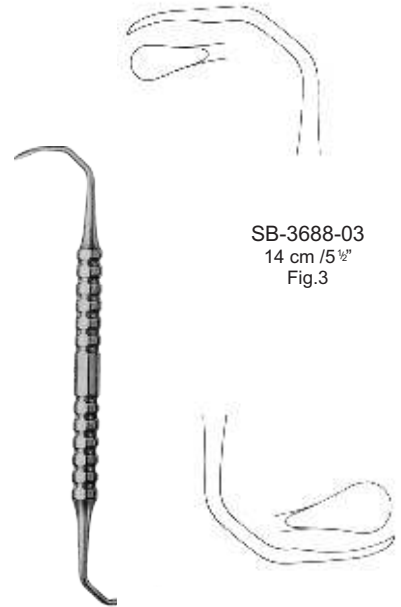

SB-3688-03  
14 cm / 5 1/2"  
Fig.3

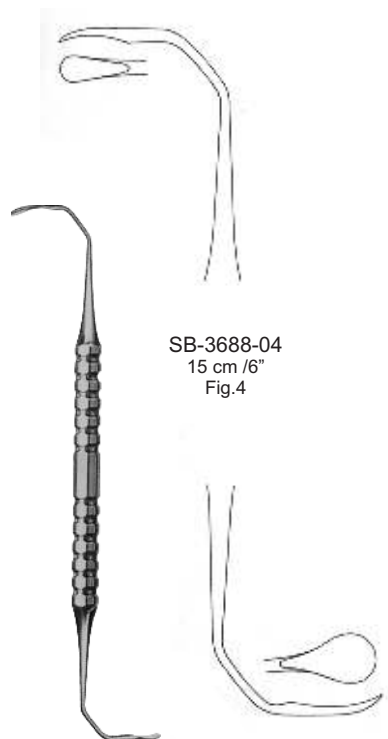

SB-3688-04  
15 cm / 6"  
Fig.4



SB-3688-05  
15 cm / 6"  
Fig.5

## Oral Maxillo Facial Surgery

Burrs & Finger Protector, Mouth Gags  
Grate und Fingerschutz, Mund Gags

Bavures & Finger Protector, Mouth Gags  
Las rebabas y el dedo protector, la boca Nauceas



**SB-3689-45**  
4.5 cm / 1 3/4"  
10 mm



**SB-3689-65**  
6.5 cm / 2 1/2"  
22 mm



**SB-3689-80**  
8 cm / 3 1/4"  
35 mm



**Adams**  
SB-3690-01

Napkin Holder Consisting of chain and two crocodile forceps  
Napkin Holder Bestehend aus Kette und zwei Krokodil Pinzette  
Napkin Holder Composée de chaîne et deux pincettes crocodile  
Servilletero Consistente en cadena y dos pinzas de cocodrilo



**Langenbeck**  
SB-3691-02  
21 mm ø



**Mauder**  
SB-3692-10  
wood  
Holz  
bois  
madera

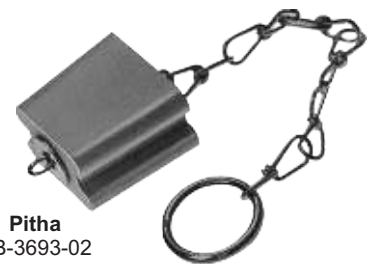

**Pitha**  
SB-3693-02  
Silicone  
Silikon  
silicone  
silicona

# Oral Maxillo Facial Surgery

Mouth Gags  
Mund Gags

Gags bouche  
Mordaza De la Boca



**Heister**  
SB-3694-13  
13 cm / 5"



**Obwegeser**  
SB-3695-11  
11 cm / 4 1/4"



**Molt**  
SB-3696-11  
11 cm / 4 1/4"



**Molt**  
SB-3697-11  
13 cm / 5"



**Denhart**  
SB-3698-11  
13 cm / 5"

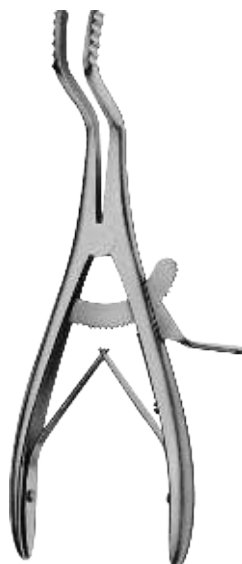

**Roser-Konig**

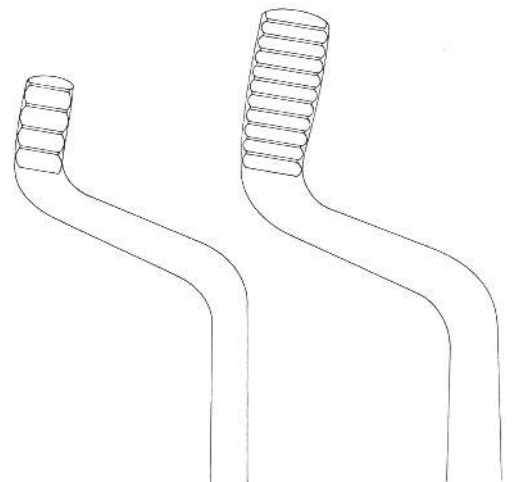

SB-3699-16  
16 cm / 6 1/4"

SB-3699-20  
20 cm / 8"

## Oral Maxillo Facial Surgery

Mouth Gags  
Mund Gags

Gags bouche  
Mordaza De la Boca



**Kilner-Doughty**  
SB-3700-00  
Chest Support



**Kilner-Doughty**  
SB-3701-00

complete with frame, 3 tongue depressors  
2 tooth plate and 1 palate plate  
komplett mit Rahmen, 3 Zungenspatel  
2 Zahnplatte und 1 Gaumenplatte  
compléter avec cadre, 3 abaisse-langue  
2 plaque dentaire et 1 plaque palatine  
completar con marco, 3 depresores de lengua  
2 diente placa y 1 placa paladar



SB-3701-01  
13.5 cm / 5 1/4"  
70 x 29 mm



SB-3701-02  
13.5 cm / 5 1/4"  
80 x 34 mm



SB-3701-03  
13.5 cm / 5 1/4"  
85 x 38 mm

# Oral Maxillo Facial Surgery

Mouth Gags  
Mund Gags

Gags bouche  
Mordaza De la Boca



**Davis-Boyle**  
SB-3702-00

complete consisting of frame and five  
tongue depressors no. 1 to 5  
komplett bestehend aus Rahmen und  
fünf Zungenspatel keine, 1 bis 5  
compléter consistant en un cadre et cinq  
abaisse-langue non, de 1 à 5  
completar consistente en un marco y cinco depresores  
de lengua no, desde 1 hasta 5



**Davis-Boyle**  
SB-3702-01

13.5 cm / 5 1/4"  
110 x 26 mm  
Tongue depressor  
Zungenspatel  
abaisse-langue  
depresor de lengua



SB-3702-02  
13.5 cm / 5 1/4"  
95 x 25 mm



SB-3702-03  
13.5 cm / 5 1/4"  
80 x 24 mm



SB-3702-04  
13.5 cm / 5 1/4"  
65 x 23 mm



SB-3702-05  
13.5 cm / 5 1/4"  
30 x 20 mm



## Oral Maxillo Facial Surgery

Mouth Gags  
Mund Gags

Gags bouche  
Mordaza De la Boca

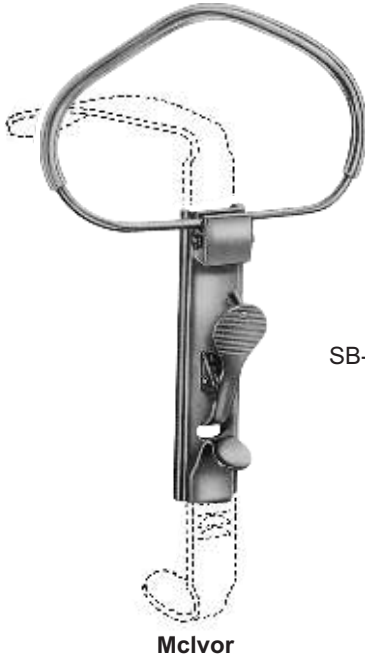

SB-3703-00

**Mclvor**

SB-3703-10  
15 cm / 6"  
Frame for Mouth Gag  
65 x 100 mm

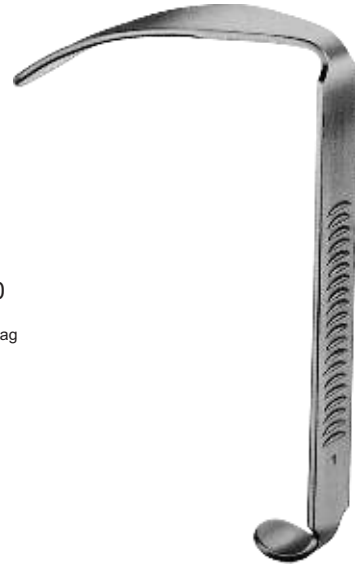

SB-3703-01  
13.5 cm / 5 1/4"  
100 x 26 mm

**Mclvor**  
Tongue Depressor

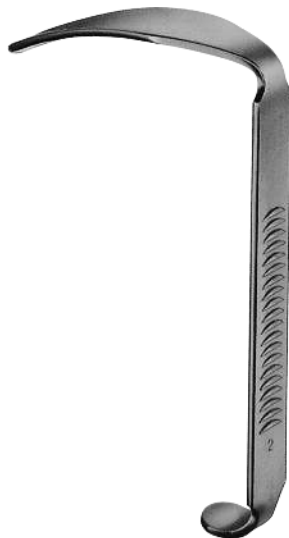

SB-3703-02  
13.5 cm / 5 1/4"  
85 x 25 mm



SB-3703-03  
13.5 cm / 5 1/4"  
75 x 23 mm

# Oral Maxillo Facial Surgery

Mouth Gags  
Mund Gags

Gags bouche  
Mordaza De la Boca

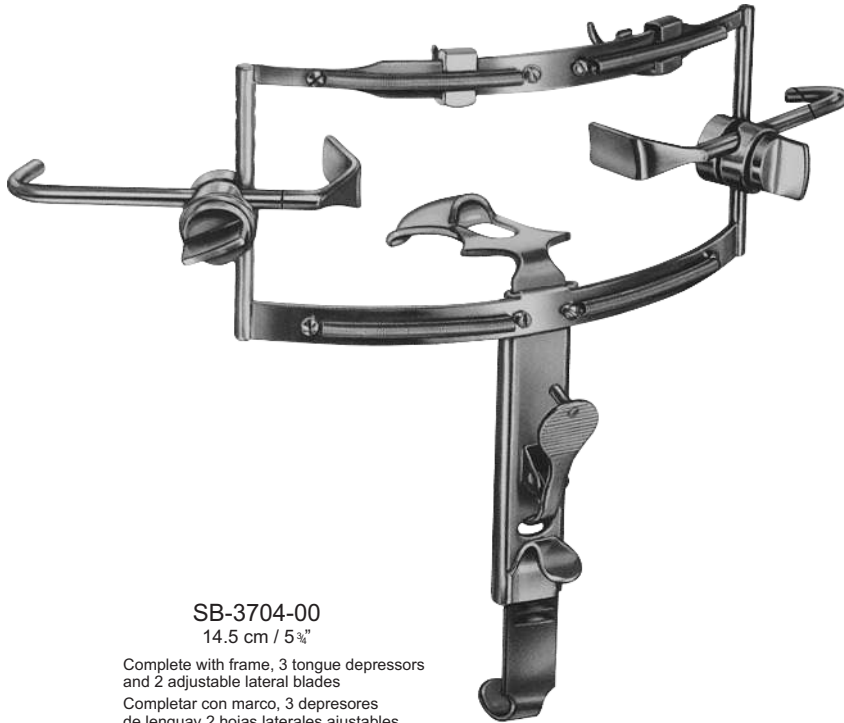

**SB-3704-00**  
14.5 cm / 5 3/4"

Complete with frame, 3 tongue depressors and 2 adjustable lateral blades

Completar con marco, 3 depresores de lengua y 2 hojas laterales ajustables

Compléter avec cadre, 3 abaisse-langue et 2 réglables lames latérales

Completar con marco, 3 depresores de lengua y 2 hojas laterales ajustables

**Dingmann**

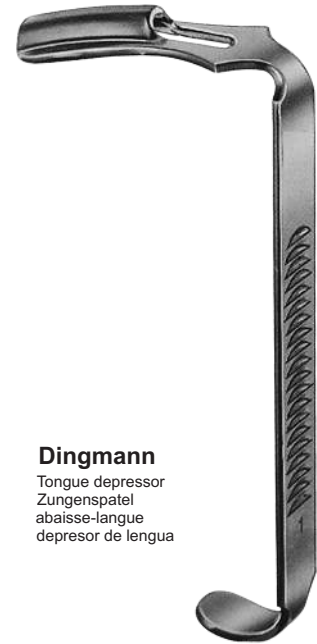

**Dingmann**

Tongue depressor  
Zungenspatel  
abaisse-langue  
depressor de lengua

**SB-3704-01**  
13.5 cm / 5 1/4"  
65 x 25 mm

**Dingmann**  
Tongue depressor  
Zungenspatel  
abaisse-langue  
depressor de lengua



**SB-3704-02**  
13.5 cm / 5 1/4"  
70 x 29 mm

**SB-3704-03**  
13.5 cm / 5 1/4"  
80 x 32 mm



**Jenninge**

**SB-3705-09** 10.5 cm / 4"

**SB-3705-11** 12.5 cm / 5"

**SB-3705-13** 10.5 cm / 5 3/4"

**SB-3705-15** 10.5 cm / 6 1/2"

## Oral Maxillo Facial Surgery

Lip and Cheek Retractors  
Lippen-und Wangenhalter

Rétracteurs lèvre et la joue  
Separadores de labios y mejillas



SB-3706-00 9.5 cm / 3 3/4" 95 mm

SB-3706-01 10 cm / 4" 110 mm

SB-3706-02 10.5 cm / 4" 115 mm

SB-3706-03 11 cm / 4 1/4" 120 mm

SB-3706-13

### Jenninge

self-retaining  
selbsthaltende  
autostatique  
auto-retención

For Children  
für Kinder  
pour les enfants  
Para los niños

set with no. 1-3  
establecido con el n. 1-3  
mis à aucune. 1-3  
establecido con el n. 1-3

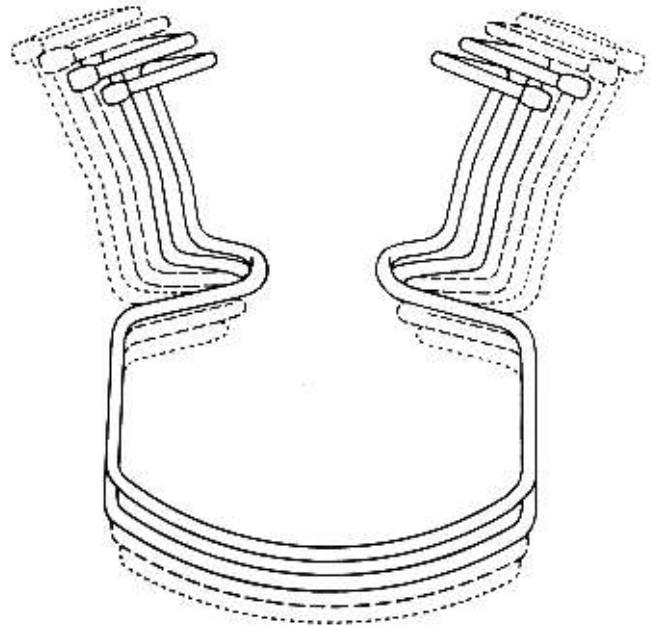

SB-3707-11  
10.5 cm / 4"



SB-3708-14  
14 cm / 5 1/2"



**Sternberg**  
SB-3709-14  
14 cm / 5 1/2"  
26 / 37 mm

# Oral Maxillo Facial Surgery

Cheek Retractors  
Wangenhalter

écarteurs  
retractores de carrillos

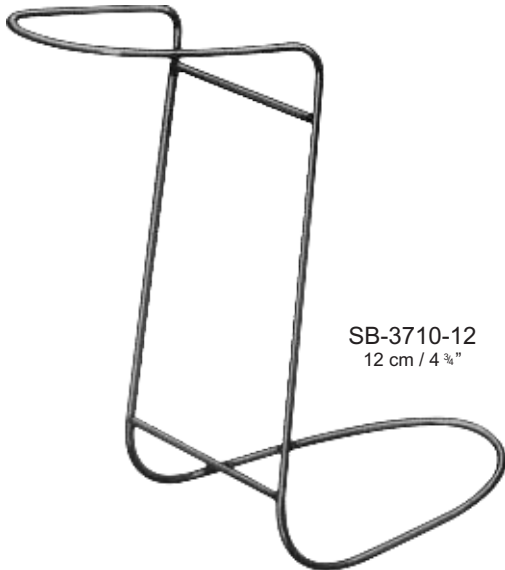

SB-3710-12  
12 cm / 4 3/4"

**Obwegeser**



SB-3711-12  
13.5 cm / 5 1/4"  
27 mm

**Bishop**



SB-3712-15  
13.5 cm / 6"  
20 mm

**Cawood-Minnesota**



SB-3713-00  
14.5 cm / 5 3/4"

Fenestrated  
gefenstert  
Fenestrated  
fenestrados

# Oral Maxillo Facial Surgery

Tongue Depressors  
Zungenspatel

Abaisse-langue  
depresores de lengua



**SB-3714-14**  
15 cm / 6"  
88 x 25 mm

**Tobold**



**SB-3715-14**  
14.5 cm / 5 7/8"  
85 x 24 mm

**Tobold**



**SB-3716-15**  
15 cm / 6 3/4"  
72 x 23 mm

**Hartmann**

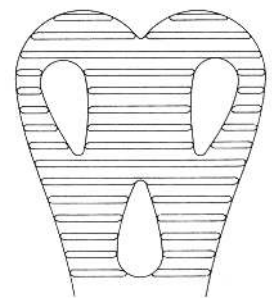

**SB-3717-01**  
14 cm / 5 1/2"  
36 mm

**Wieder**

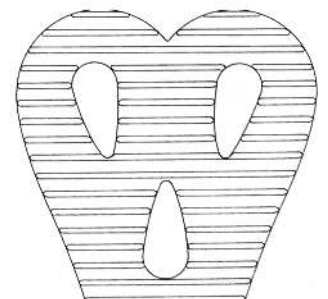

**SB-3717-02**  
15 cm / 6"  
43 mm

## Oral Maxillo Facial Surgery

Tongue Spatulas  
Zungenspatel

Spatules Tongue  
Espátulas Lengua



**Doyen**

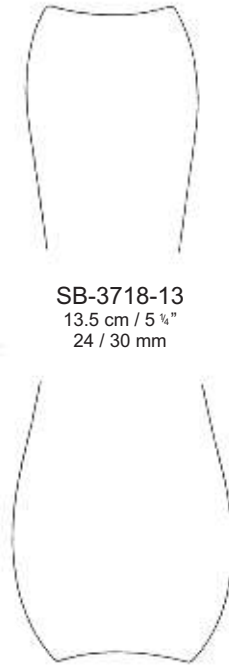

**SB-3718-13**  
13.5 cm / 5 1/4"  
24 / 30 mm

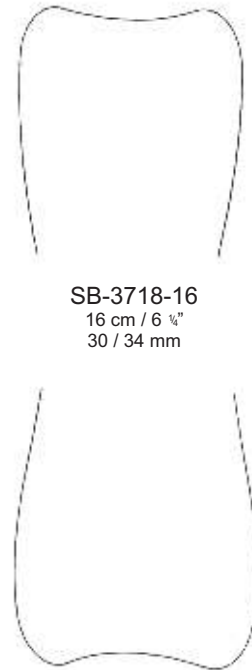

**SB-3718-16**  
16 cm / 6 1/4"  
30 / 34 mm



**SB-3719-16**  
15 cm / 6"

Package of 100  
pieces plastic  
Paket von 100  
Stück Kunststoff  
Paquet de 100  
plastique morceaux  
Paquete de 100  
piezas de plástico



**SB-3720-16**  
16 cm / 6 1/4"

Package of 100  
pieces wood  
Paket von 100  
Stück Holz  
Paquet de 100  
des morceaux de bois  
Paquete de 100  
piezas de madera



**SB-3721-19**  
19 cm / 7 1/2"  
19 / 15 mm

**Brunings**

## Oral Maxillo Facial Surgery

Tongue Holding Forceps  
Zungenzangen

Tongue Davier  
Lengua pinzas de sujeción



**Collin**

SB-3722-17  
17 cm / 6 3/4"  
Jaw 24 x 27 mm



**Young**

SB-3723-15  
15 cm / 6"

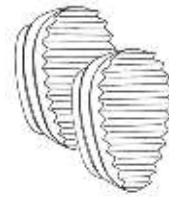

SB-3724-02  
Rubber Inserts  
23 x 15 mm

Rubber Inserts  
Gummielagen  
Inserts en caoutchouc  
Insertos de goma

## Oral Maxillo Facial Surgery

Extra Oral Retractors  
Extraoralen Retraktoren

Supplémentaires Rétracteurs orale  
Retractores extra orales



**SB-3725-24**  
22 cm / 8 3/4"  
9.5 mm / 16 mm

concave blade, fully bent tip  
konkave Klinge, komplett gebogene Spitze  
concave lame, pointe entièrement plié  
cóncava hoja, tip completamente doblado

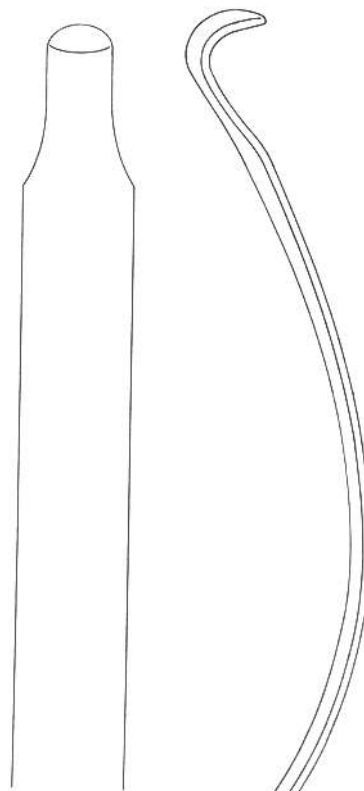

**SB-3726-25**  
25.5 cm / 10"  
9.5 mm / 16 mm

concave blade, fully bent tip  
konkave Klinge, komplett gebogene Spitze  
concave lame, pointe entièrement plié  
cóncava hoja, tip completamente doblado



## Oral Maxillo Facial Surgery

Intra Oral Retractors  
Intra Oral Retraktoren

Intra Rétracteurs orale  
Retractores Intra Oral



**SB-3727-23**

23 cm / 9"  
25.5 mm

for Lefort osteotomies  
für Lefort Osteotomien  
pour Lefort ostéotomies  
osteotomías Lefort para

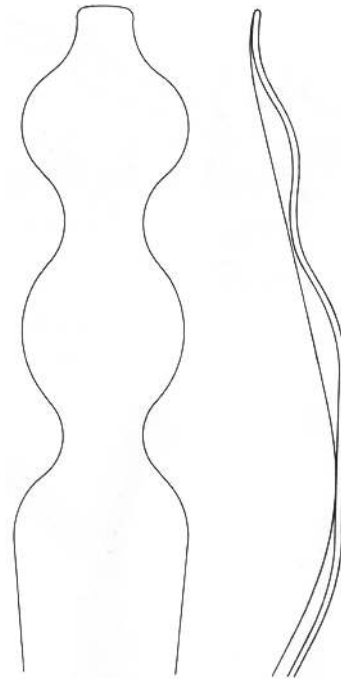

**SB-3728-27**

27 cm / 10<sup>3</sup>/<sub>4</sub>"  
25.5 mm

for Lefort osteotomies  
für Lefort Osteotomien  
pour Lefort ostéotomies  
osteotomías Lefort para

# Oral Maxillo Facial Surgery

Intra Oral Retractors  
Intra Oral Retraktoren

Intra Rétracteurs orale  
Retractores Intra Oral



**SB-3729-21**  
21 cm / 8 1/4"  
26.5 / 16 mm  
Right  
rechts  
droit  
derecho



**SB-3730-21**  
21 cm / 8 1/4"  
26.5 / 16 mm  
Left  
links  
links  
Izquierda



**SB-3731-24**  
24.5 cm / 9 3/4"  
26.5 / 16 mm  
Right  
rechts  
droit  
derecho



**SB-3732-24**  
24.5 cm / 9 3/4"  
26.5 / 16 mm  
Left  
links  
links  
Izquierda

# Oral Maxillo Facial Surgery

Intra Oral Retractors  
Intra Oral Retraktoren

Intra Rétracteurs orale  
Retradores Intra Oral



**SB-3733-25**  
25 cm / 9"  
12.5 / 27 mm



**SB-3734-28**  
28 cm / 11"  
12.5 / 27 mm

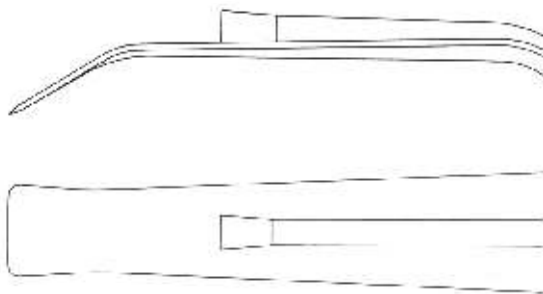
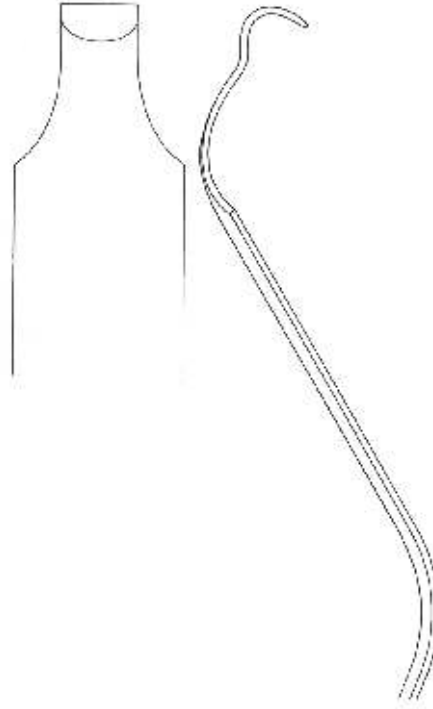

**SB-3735-22**  
22 cm / 8 3/4"  
14.5 mm

**Shea**  
Multi Purpose Retractor  
Multi Purpose Retractor  
Écarteur Multi Purpose  
Retractor multiuso

## Oral Maxillo Facial Surgery

Ramus Retractors  
Ramus Retraktoren

Rétracteurs Ramus  
Los retractoros de rama



**SB-3736-40**  
21.5 cm / 8 1/2"  
43 x 11 mm

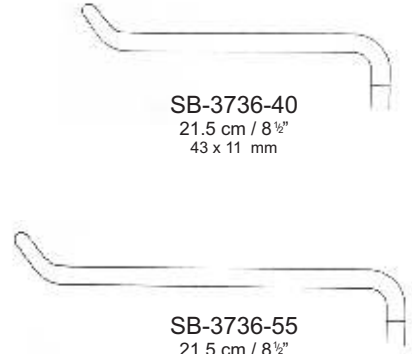

**SB-3736-55**  
21.5 cm / 8 1/2"  
57 x 11 mm



**SB-3736-80**  
21.5 cm / 8 1/2"  
83 x 16 mm



**SB-3737-22**  
22 cm / 8 3/4"  
Nasal Spine Retractor  
45 x 10 mm

Nasal Spine Retractor  
Nasal Spine Retractor  
Écarteur épine nasale  
Retractor nasal Columna Vertebral

Obwegeser

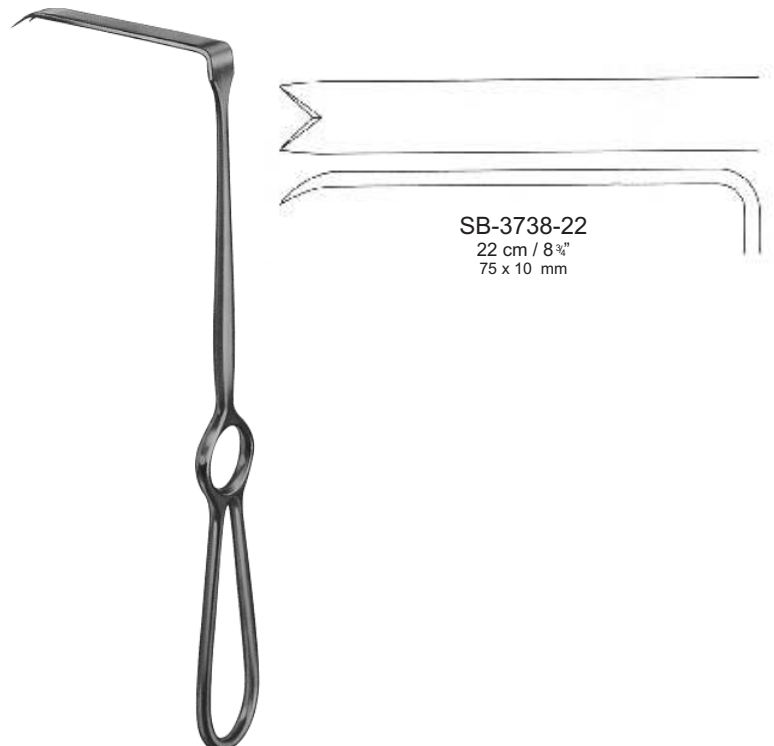

**SB-3738-22**  
22 cm / 8 3/4"  
75 x 10 mm

Obwegeser

# Oral Maxillo Facial Surgery

Progeny Retractor  
Progeny Retractor

Ecarteur Progeny  
Progenie retractor



**Obwegeser**  
SB-3739-16  
16.5 cm / 6 1/2"



**Obwegeser**  
SB-3740-08 17 cm / 6 3/4" 8 mm  
SB-3740-10 17 cm / 6 3/4" 10 mm

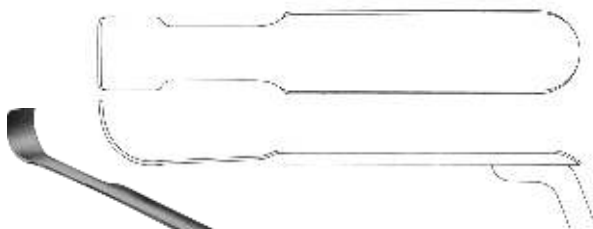

SB-3741-10  
15 cm / 6"

**Schuchardt**

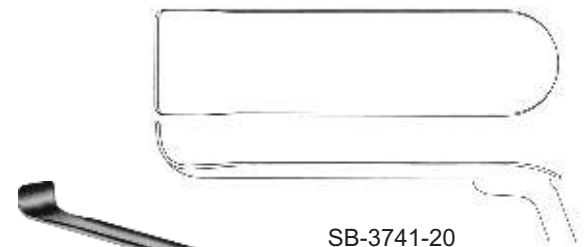

SB-3741-20  
15 cm / 6"

**Metz**

# Oral Maxillo Facial Surgery

Retractors, Periosteal Elevators  
Retraktoren, Raspatorien

Rétracteurs, rugines  
Retradores, ascensores periostio



**Koberg, mod**



**SB-3742-01**  
18.5 cm / 7 1/4"  
14 x 7 mm



**SB-3742-02**  
18.5 cm / 7 1/4"  
20 x 7 mm



**SB-3743-01**  
18 cm / 7"  
3x18 mm

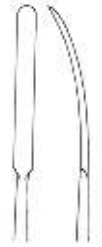

**SB-3743-02**  
18 cm / 7"  
3.5x23 mm



**Obwegeser**



**SB-3744-06**  
17.5 cm / 7"  
6 mm



**SB-3744-07**  
17.5 cm / 7"  
7 mm



**SB-3744-09**  
17.5 cm / 7"  
9 mm



**SB-3744-11**  
17.5 cm / 7"  
11 mm

# Oral Maxillo Facial Surgery

Periosteal Elevators, Elevators  
Raspatorien, Aufzüge

Rugines, Ascenseurs  
Ascensores, elevadores periósticos



SB-3745-05  
20.5 cm / 8"  
5 mm



SB-3745-07  
20.5 cm / 8"  
7 mm



SB-3745-09  
20.5 cm / 8"  
9 mm



SB-3746-01

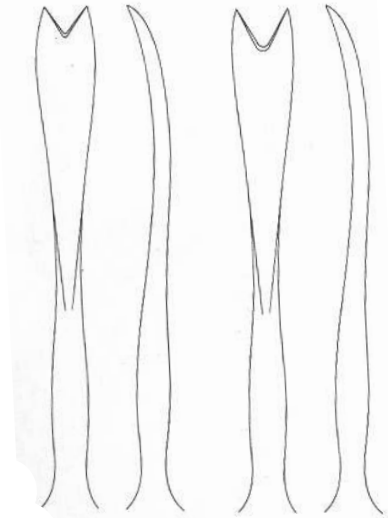

SB-3746-02

**Obwegeser**

**Obwegeser**  
17.5 cm / 7"



**Obwegeser**  
20.5 cm / 8"



SB-3747-21



**Obwegeser**  
20.5 cm / 8"



SB-3748-21



**Hargis**

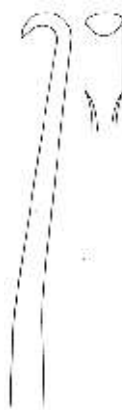

SB-3749-01  
23 cm / 9"  
6.5 mm  
Right  
rechts  
droit  
derecho



SB-3749-02  
23 cm / 9"  
9 mm  
Right  
rechts  
droit  
derecho



SB-3749-03  
23 cm / 9"  
6.5 mm  
Left  
links  
links  
Izquierda

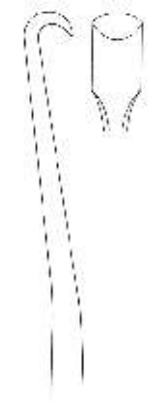

SB-3749-04  
23 cm / 9"  
9 mm  
Left  
links  
links  
Izquierda

# Oral Maxillo Facial Surgery

Zygoma Elevators, Channel Retractor  
Zygoma Aufzüge, Channel Retractor

Ascenseurs Zygoma, écarteur Manche  
Zygoma elevadores, separador de canales

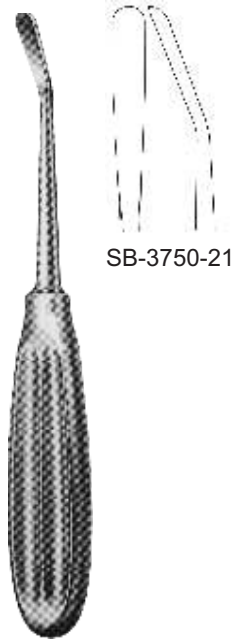

**Gillies**  
20 cm / 8"

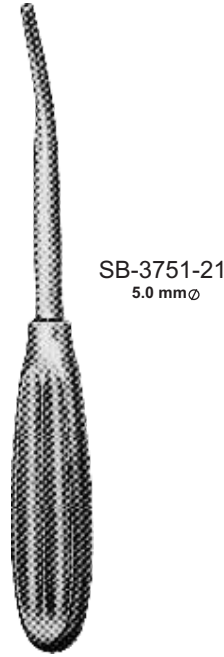

**Dingmann**  
21 cm / 8 $\frac{1}{4}$ "



**Dingmann-Wilk**  
20 cm / 8"



**Steinhauser**



**Steinhauser**



# Oral Maxillo Facial Surgery

Periosteal Elevators  
Raspatorien

Rugines  
Elevadores periostio



**SB-3755-18**  
18 cm / 7"

## Steinhauser

Reposition Instruments  
positionieren Instruments  
repositionner Instruments  
Vuelva a colocar los instrumentos

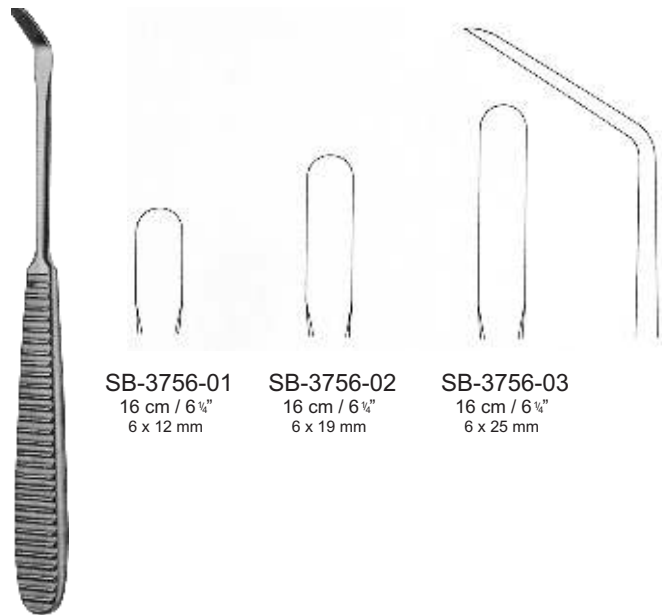

**SB-3756-01**  
16 cm / 6 1/4"  
6 x 12 mm

**SB-3756-02**  
16 cm / 6 1/4"  
6 x 19 mm

**SB-3756-03**  
16 cm / 6 1/4"  
6 x 25 mm

## Steinhauser

# Oral Maxillo Facial Surgery

Lattice Splints  
Lattice Schienen

attelles en treillis  
Las tablillas de celosía



**SB-3757-02**  
Package with 10 pieces  
Packung mit 10 Stück  
Paquet de 10 pièces  
Paquete con 10 piezas



**SB-3758-13**  
13 cm / 5"

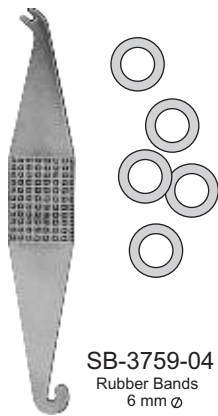

**SB-3759-04**  
Rubber Bands  
6 mm  $\varnothing$   
Rubber Bands  
bandes élastiques  
Las bandas de goma

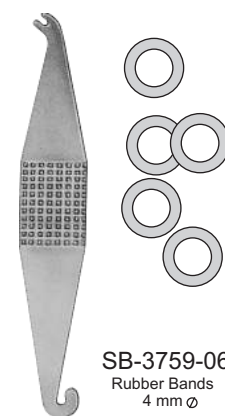

**SB-3759-06**  
Rubber Bands  
4 mm  $\varnothing$   
Rubber Bands  
bandes élastiques  
Las bandas de goma

## Oral Maxillo Facial Surgery

Wire Pushers, Arch Bar  
Draht-Pusher, Arch Bar

Poussoirs fils, Arch Bar  
Los empujadores de alambre, Arch Bar



**SB-3760-00**  
17 cm / 6 3/4"



**SB-3761-00**  
15 cm / 6"

**Rowe**



**SB-3762-01**  
15 cm / 6"



**Mershon**

# Oral Maxillo Facial Surgery

Bone Holding Forceps  
Knochenhaltezangen

Os Davier  
Bone Pinzas

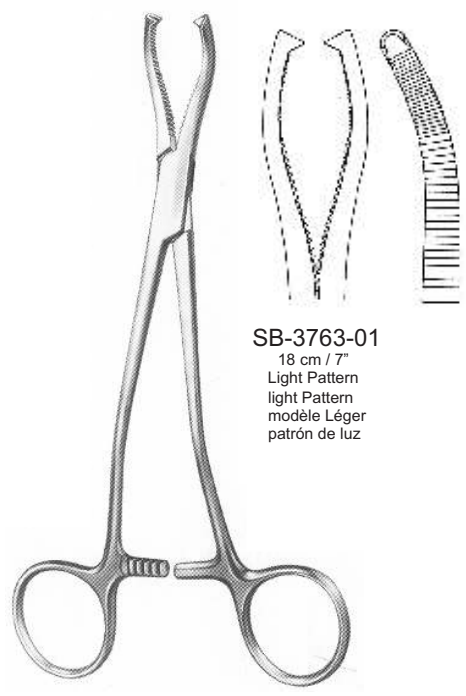

**SB-3763-01**  
18 cm / 7"  
Light Pattern  
light Pattern  
modèle Léger  
patrón de luz

**Jeter-Van Sickers**

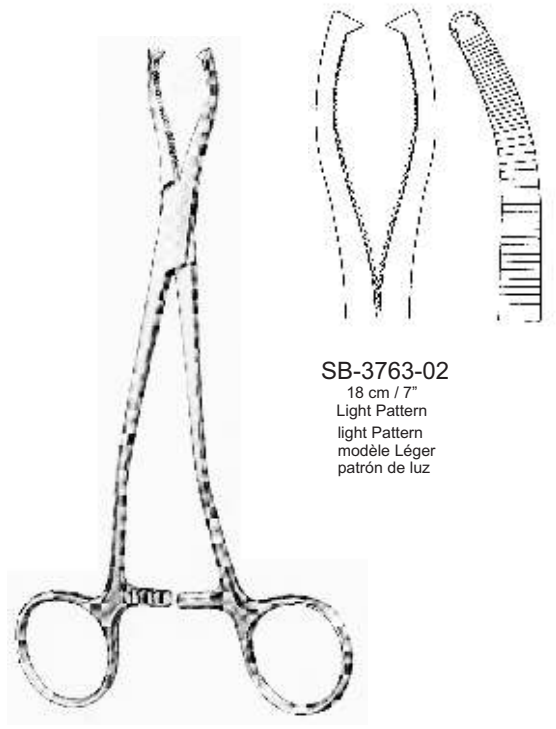

**SB-3763-02**  
18 cm / 7"  
Light Pattern  
light Pattern  
modèle Léger  
patrón de luz

**Jeter-Van Sickers**



**SB-3764-01 SB-3764-02**  
Left links links Izquierda  
Right rechts droit derecho

**Keen**  
17.5 cm / 6 3/4"



**Steinhauser**  
**SB-3765-01**  
13cm / 5"



**Steinhauser**  
**SB-3765-02**  
13cm / 5"

# Oral Maxillo Facial Surgery

Bone Holding Forceps  
Knochenhaltezangen

Os Davier  
Bone Pinzas



**Sakamoto**  
SB-3766-00  
14cm / 5 1/2"



SB-3767-00  
16 cm / 6 1/2"

**Salyer**



SB-3768-25  
25 cm / 10"

**Welford**



SB-3769-25  
19 cm / 7 1/2"

with chain  
mit Kette  
avec la chaîne  
con cadena

**Hargis**

# Oral Maxillo Facial Surgery

Disimpaction Forceps  
disimpaction Zange

Pince désimpaction  
Pinzas desimpactación



**Rowe**  
Left  
links  
links  
Izquierda

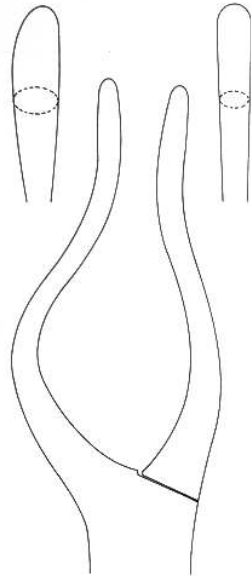

SB-3770-01  
SB-3771-01  
22.5 cm / 8 3/4"  
Left

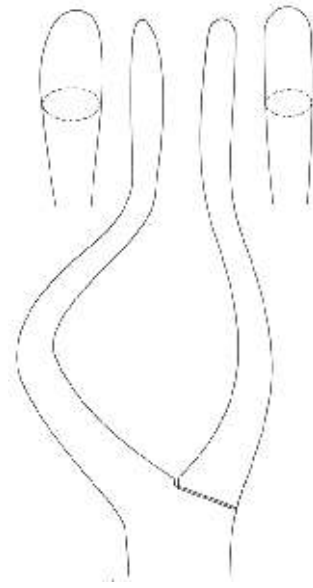

SB-3770-02  
SB-3771-02  
23.5 cm / 9 1/4"



**Rowe**  
Right

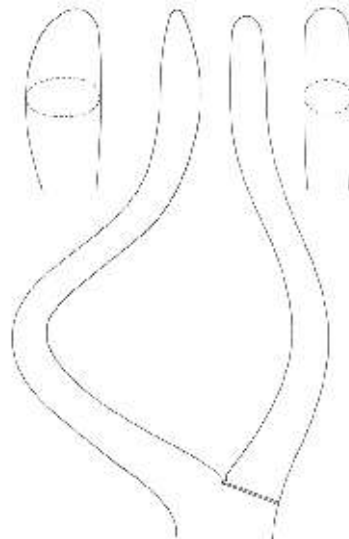

# Oral Maxillo Facial Surgery

LeFort I Retractors, Sinus Lift and Zygomatic Retractors  
LeFort I Retraktoren, Sinus Lift und Jochbein Retraktoren

Lefort Rétracteurs I, Sinus Lift et Rétracteurs zygomatiques  
Lefort I retractores, Sinus Lift y retractores cigomáticos



**Arnhem**  
22 cm / 8 3/4"

Lefort I Retractor  
Lefort enrouleur je  
Lefort I Retractor

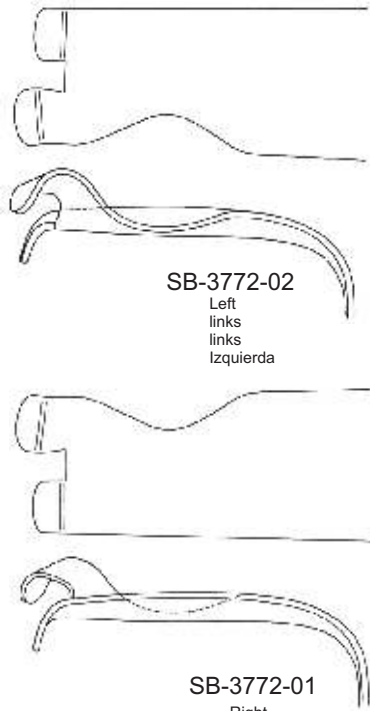

**SB-3772-02**  
Left  
links  
links  
Izquierda

**SB-3772-01**  
Right  
rechts  
droit  
derecho



**Arnhem**  
22 cm / 8 3/4"

Sinus Lift Retractor  
Écarteur Sinus Lift  
Sinus Lift Retractor

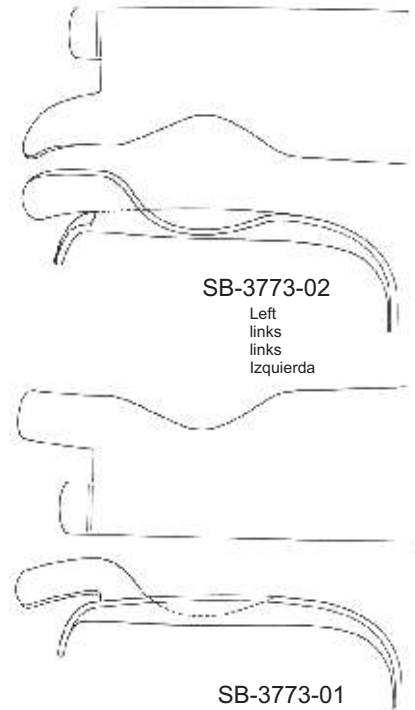

**SB-3773-02**  
Left  
links  
links  
Izquierda

**SB-3773-01**  
Right  
rechts  
droit  
derecho



**Steinhauser**

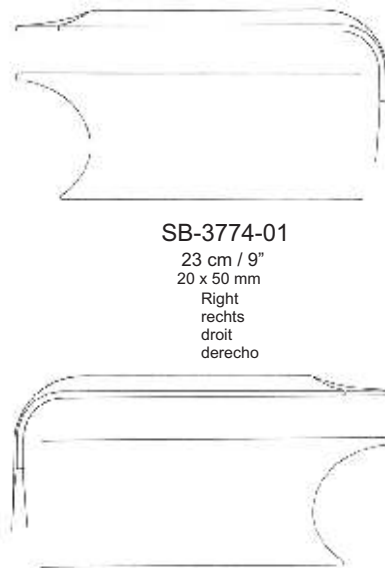

**SB-3774-01**  
23 cm / 9"  
20 x 50 mm  
Right  
rechts  
droit  
derecho

**SB-3774-02**  
23 cm / 9"  
20 x 50 mm  
Left  
links  
links  
Izquierda

**Oral Maxillo Facial Surgery**

Ramus Retractor, Mandibular Body, Retractor,  
Anterior Border Stripper, Periform Rim Retractor  
Ramus Retractor, Gebissknochen, Retraktor  
Vorderen Rand Stripper, PERiform Rim Retractor

Ecarteur Ramus, corps de la mandibule, enrouleur,  
Décapant bord antérieur, Periform Rim Écarteur  
Separador de rama, cuerpo mandibular, retractor,  
Stripper borde anterior, periforme culo retractor



**Hargis**

Lip and Cheek Retractors  
Lippen-und Wangenhalter  
Ecarteurs lèvre et la joue  
Labios y Mejillas Retractores

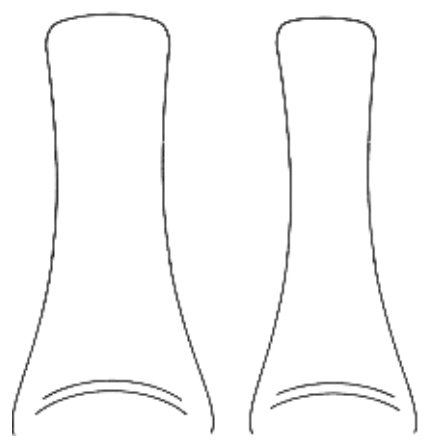

**SB-3775-00**  
16 cm / 6 1/4"



**Hargis**

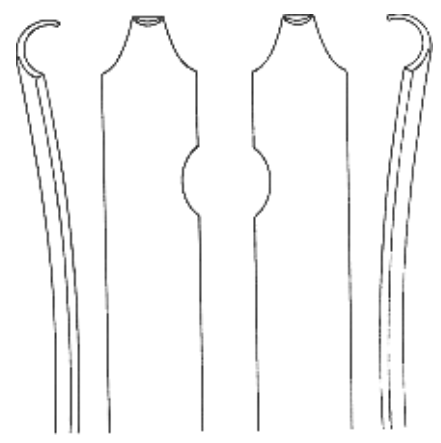

**SB-3776-01**  
19.5 cm / 7 3/4"  
Right  
rechts  
droit  
derecho

**SB-3776-02**  
19.5 cm / 7 3/4"  
Left  
links  
links  
Izquierda



**SB-3777-18**  
18 cm / 7"

**Hargis**



**SB-3778-19**  
19 cm / 7 1/2"

**Hargis**

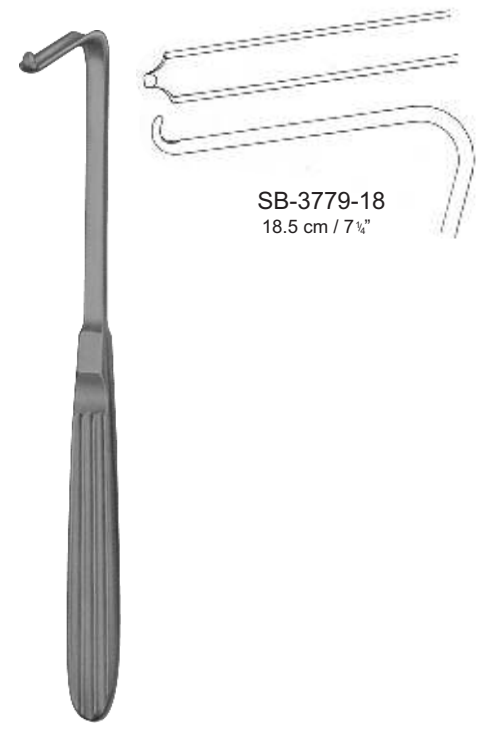

**SB-3779-18**  
18.5 cm / 7 1/4"

**Hargis**



## Oral Maxillo Facial Surgery

Sagittal Split Separators, Ramus Separator  
Sagittal Split Separatoren, Ramus Separator

Séparateurs clivage sagittal, les séparateurs Ramus  
Separadores Sagital Split, separadores Ramus

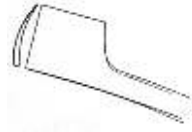

**SB-3780-01**  
18.5 cm / 7 1/4"  
9 mm  
Right  
rechts  
droit  
derecho

**Smith**



**SB-3780-02**  
18.5 cm / 7 1/4"  
9 mm  
Left  
links  
links  
Izquierda

**Smith**



**SB-3781-23**  
23.5 cm / 9 1/4"

**Smith**

**Oral Maxillo Facial Surgery**

Channel Retractors, Ramus Pusher,  
Wir Introducer, Septal Osteotome, Duct Retractors  
Channel-Retraktoren, Ramus Pusher,  
Wir Introducer, Septal Osteotom, Duct Retraktoren

Rétracteurs Channel, Pusher Ramus,  
Wir introducteur, ostéotomes septale, écarteurs de conduits  
Los retractoros del canal, empujador Ramus,  
Wir Introductor, osteotomo septal, retractoros de ductos



SB-3782-18  
16.5 cm / 6 1/2"

Terry



SB-3783-24  
24 cm / 9 1/2"

Terry

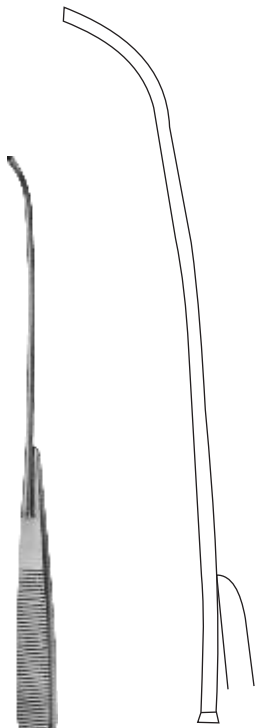

SB-3784-17  
17 cm / 6 3/4"

Terry



SB-3785-19  
19 cm / 7 1/2"

Terry



Terry

SB-3786-00  
14 cm / 5 1/2"



Terry

SB-3786-01  
15 cm / 6 "

Left  
links  
links  
Izquierda



Terry

SB-3786-02  
15 cm / 6 "

Right  
rechts  
droit  
derecho

## Oral Maxillo Facial Surgery

Mylohyoid Muscle and Ramus Clamps  
M. mylohyoideus und Ramus Schellen

Muscle mylo-hyoïdien et pinces Ramus  
Músculo milohioideo y abrazaderas de rama

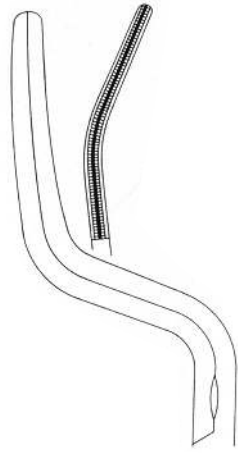
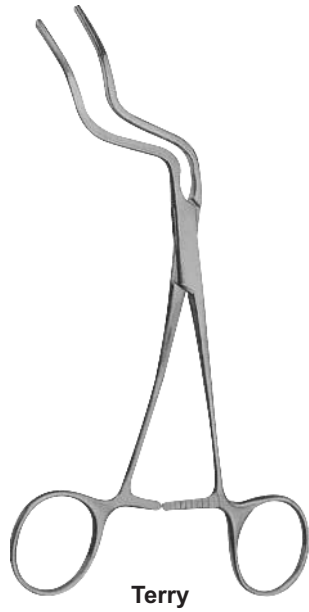

SB-3787-01  
17 cm / 6 3/4"  
Left  
links  
links  
Izquierda

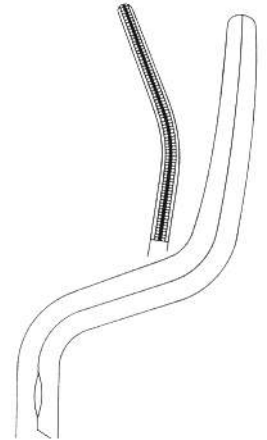

SB-3787-02  
17 cm / 6 3/4"  
Right  
rechts  
droit  
derecho

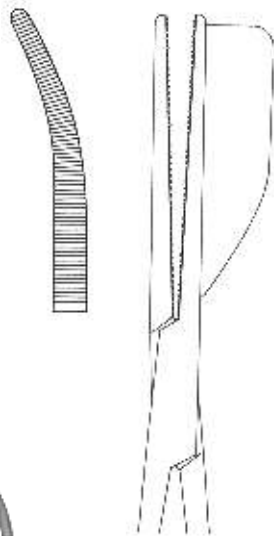

SB-3788-01  
16 cm / 6 1/4"  
Right  
rechts  
droit  
derecho

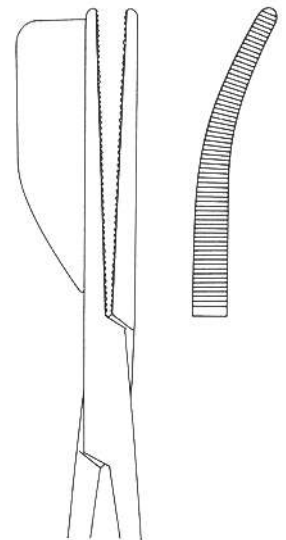

SB-3788-02  
16 cm / 6 1/4"  
Left  
links  
links  
Izquierda

# Oral Maxillo Facial Surgery

Osteotomes      ostéotomes  
Osteotome      osteotomos

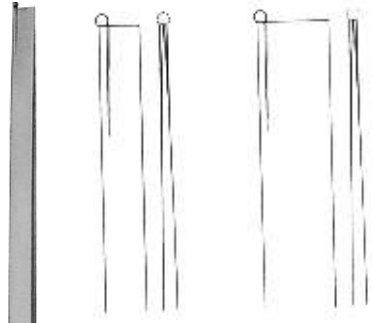

SB-3789-00  
20.5 cm / 8"  
6 mm

SB-3789-01  
20.5 cm / 8"  
8 mm

**Bauer**

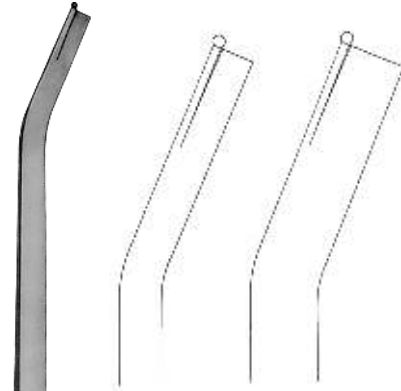

SB-3790-00  
20.5 cm / 8"  
6 mm

SB-3790-01  
20.5 cm / 8"  
8 mm

**Bauer**

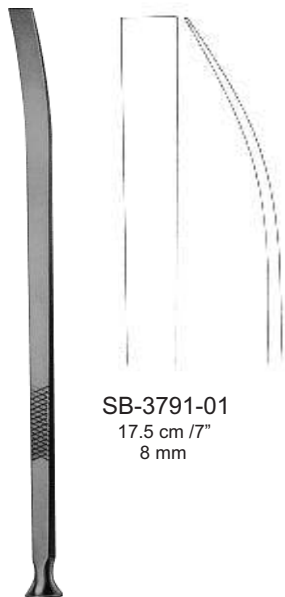

SB-3791-01  
17.5 cm / 7"  
8 mm

**Epker-Bauer**

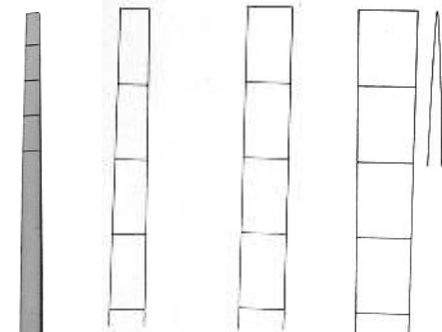

SB-3792-04  
18 cm / 7"  
4 x 1.2 mm

SB-3792-06  
18 cm / 7"  
6 x 1.2 mm

SB-3792-08  
18 cm / 7"  
8 x 1.2 mm

**Epker**

# Oral Maxillo Facial Surgery

Osteotomes  
Osteotome

ostéotomes  
osteotomos



**Epker**

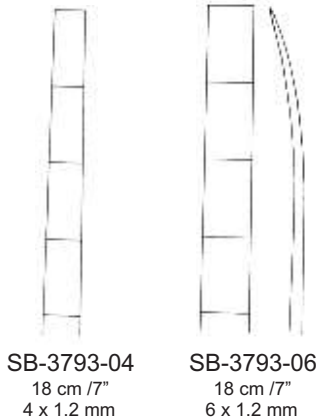

**SB-3793-04**  
18 cm / 7"  
4 x 1.2 mm

**SB-3793-06**  
18 cm / 7"  
6 x 1.2 mm



**Epker**

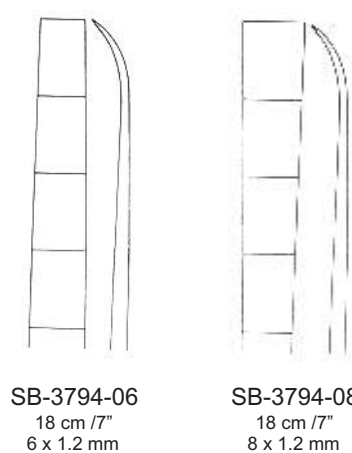

**SB-3794-06**  
18 cm / 7"  
6 x 1.2 mm

**SB-3794-08**  
18 cm / 7"  
8 x 1.2 mm



**Steinhauser**  
Flexible

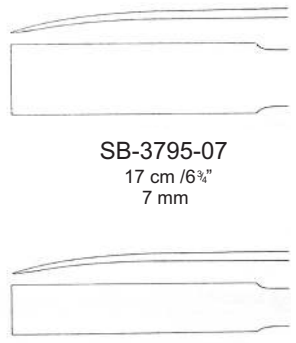

**SB-3795-07**  
17 cm / 6 3/4"  
7 mm

**SB-3795-10**  
17 cm / 6 3/4"  
10 mm



**Steinhauser**  
Flexible

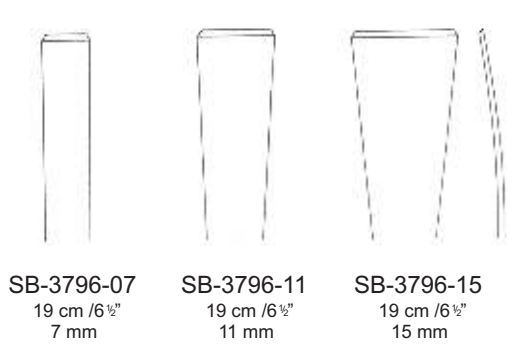

**SB-3796-07**  
19 cm / 6 1/2"  
7 mm

**SB-3796-11**  
19 cm / 6 1/2"  
11 mm

**SB-3796-15**  
19 cm / 6 1/2"  
15 mm

# Oral Maxillo Facial Surgery

Raspatories, Osteotomes  
Raspatories, Osteotome

Raspatories, les ostéotomes  
Raspatories, osteotomos



SB-3797-16  
16.5 cm / 6½"  
3 mm

Steinhauser



SB-3798-05  
18 cm / 7½"  
5 mm

Steinhauser



SB-3798-08  
18 cm / 7"  
8 mm

Steinhauser



SB-3799-06  
23 cm / 9"  
6 mm

Wolford

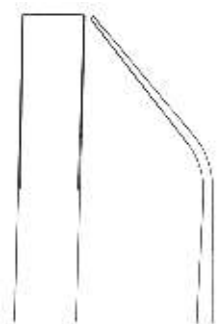
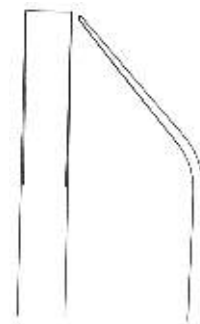

SB-3799-08  
23 cm / 9"  
8 mm

# Oral Maxillo Facial Surgery

Cleft Palate Instruments  
Gaumenspalte Instruments

Instruments fente palatine  
Instrumentos del paladar hendido

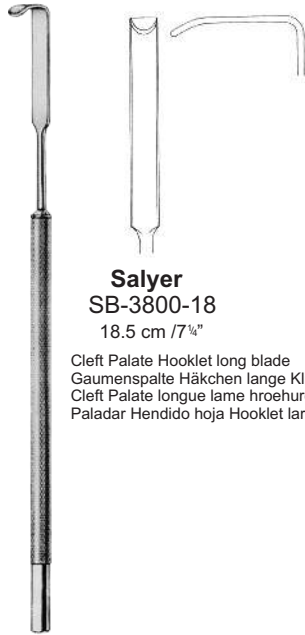

**Salyer**  
**SB-3800-18**  
18.5 cm / 7<sup>1</sup>/<sub>4</sub>"

Cleft Palate Hooklet long blade  
Gaumenspalte Håkchen lange Klinge  
Cleft Palate longue lame hroehure  
Paladar Hendido hoja Hooklet largo



**Salyer**  
**SB-3801-18**  
18.5 cm / 7<sup>1</sup>/<sub>4</sub>"

Cleft Palate Hooklet long blade  
Gaumenspalte Håkchen lange Klinge  
Cleft Palate longue lame hroehure  
Paladar Hendido hoja Hooklet largo



**Salyer**  
**SB-3802-18**  
18 cm / 7"

Cleft Palate Dissector nasal  
Gaumenspalte Dissector nasale  
Fente palatine Dissector nasale  
Paladar Hendido Dissector nasal



**Salyer**  
**SB-3803-18**  
18 cm / 7"

Cleft Palate Dissector nasal  
Gaumenspalte Dissector nasale  
Fente palatine Dissector nasale  
Paladar Hendido Dissector nasal



**Salyer**  
**SB-3804-18**  
18 cm / 7"

Cleft Palate Instruments  
Gaumenspalte Instruments  
Instruments fente palatine  
Instrumentos Paladar Hendido



**Salyer**  
**SB-3805-18**  
18 cm / 7"

Cleft Palate Elevator  
Gaumenspalte Aufzug  
Ascenseur fente palatine  
Ascensor Paladar Hendido



**Salyer**  
**SB-3806-18**  
18 cm / 7"

Cleft Palate Elevator  
Gaumenspalte Aufzug  
Ascenseur fente palatine  
Ascensor Paladar Hendido



**Jaboma**  
**SB-3807-18**  
17 cm / 6<sup>3</sup>/<sub>4</sub>"

Cleft Palate Periosteal  
Gaumenspalte Periosteal  
Périostique fente palatine  
Periostótomo Paladar Hendido

## Oral Maxillo Facial Surgery

Palatal Expander  
Palatal Expander

palatine Expander  
Expansor de paladar:



**Turvey**



**Salyer**  
SB-3808-17  
17 cm / 6<sup>3</sup>/<sub>4</sub>"





*Serving Health Care*

# **SPEED BIRD**

## **ENTERPRISES**



**161/C, SMALL INDUSTRIAL ESTATE  
SIALKOT-51310, (PAKISTAN)**



**: +92-304 0549944**



**: +92-52-3555584**



**: speed@birddent.com**



**: www.birddent.com**