



Serving Health Care

SPEED BIRD
ENTERPRISES

www.birddent.com

RHINOLOGY INSTRUMENTS

SECTION

24

Rhinology Instruments

Nasal Specula
Nasenspekula

nasale spéculer
Espéculo nasal



Goldsmith (Thudichum)



SB-3546-01
6,5 cm/2 1/2"
Fig.1



SB-3546-02
6,5 cm/2 1/2"
Fig.2

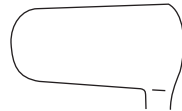

SB-3546-03
6,5 cm/2 1/2"
Fig.3



SB-3547-01



SB-3547-02



SB-3547-03



Voltolini



Hartmann-Halle

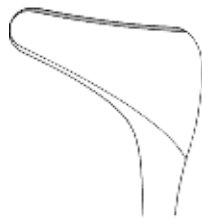

SB-3548-01
15,5 cm/6"
Fig.1

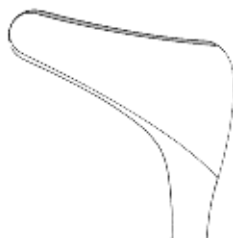

SB-3548-02
15,5 cm/6"
Fig.1

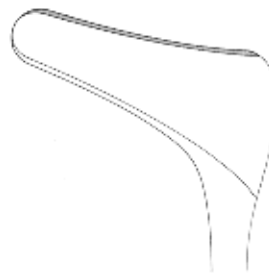

SB-3548-03
15,5 cm/6"
Fig.1

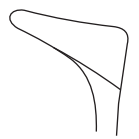

SB-3549-13
13 cm/5"

Rhinology Instruments

Nasal Specula
Nasenspekula

nasale spéculer
Especulo nasal

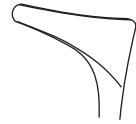

SB-3550-13
1,5 cm/5"

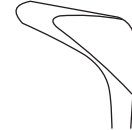

SB-3551-13
13 cm/5"

Tieck-Halle



Killian

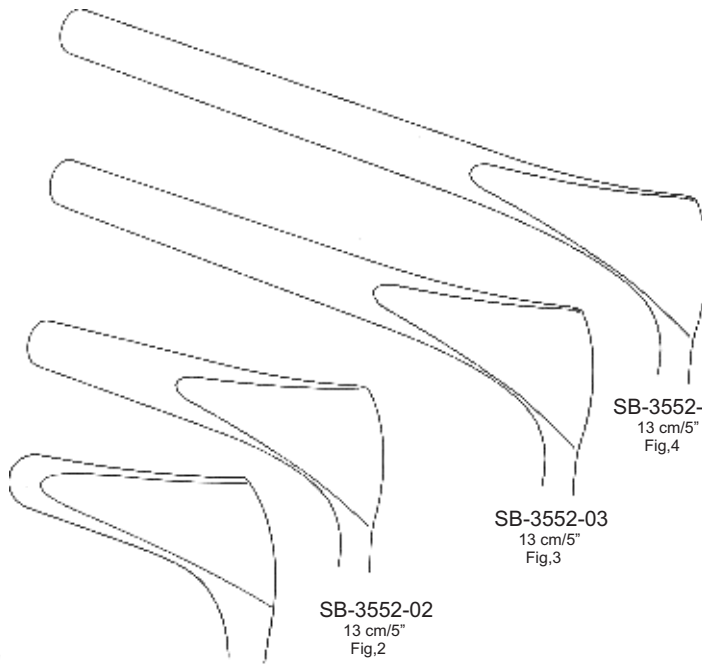

SB-3552-01
13 cm/5"
Fig,1

SB-3552-02
13 cm/5"
Fig,2

SB-3552-03
13 cm/5"
Fig,3

SB-3552-04
13 cm/5"
Fig,4



Model-Wien

SB-3553-14
12,5 cm/5 1/4"
Fig,4

Rhinology Instruments

Nasal Specula
Nasenspekula

nasale spéculer
Espéculo nasal



Clittle

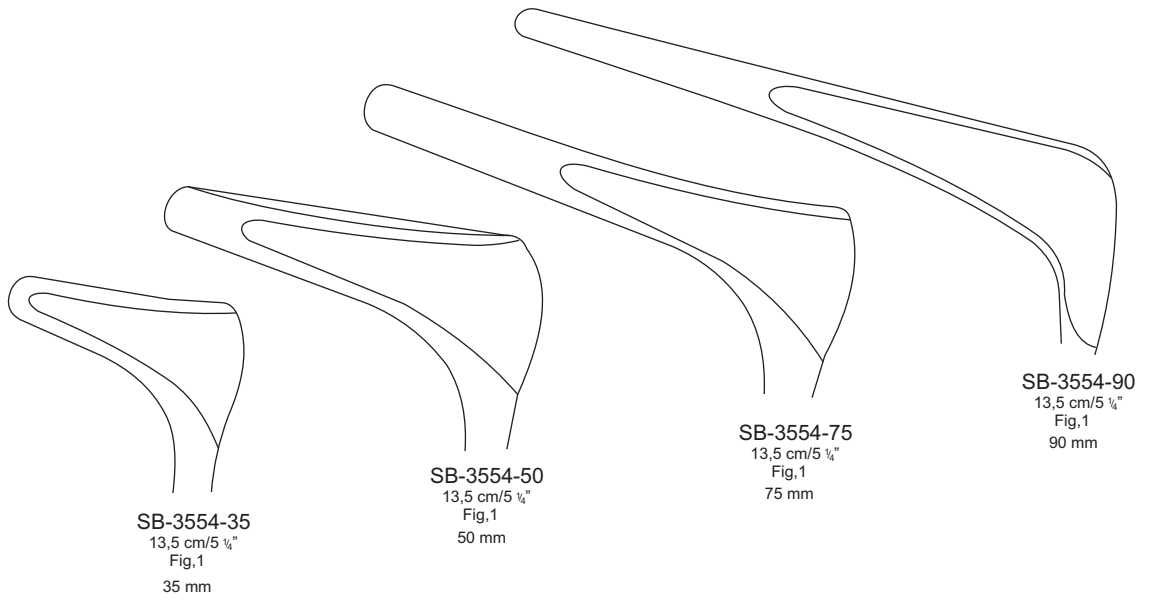

SB-3554-35
13,5 cm/5 1/4"
Fig.1
35 mm

SB-3554-50
13,5 cm/5 1/4"
Fig.1
50 mm

SB-3554-75
13,5 cm/5 1/4"
Fig.1
75 mm

SB-3554-90
13,5 cm/5 1/4"
Fig.1
90 mm



Clittle

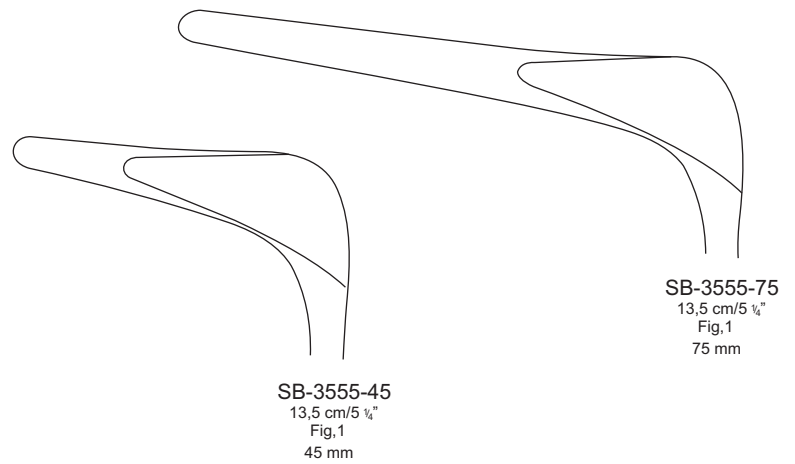

SB-3555-45
13,5 cm/5 1/4"
Fig.1
45 mm

SB-3555-75
13,5 cm/5 1/4"
Fig.1
75 mm

Rhinology Instruments

Polypus Snares
Polypus Snares

Polypus Snares
pólipos Snares

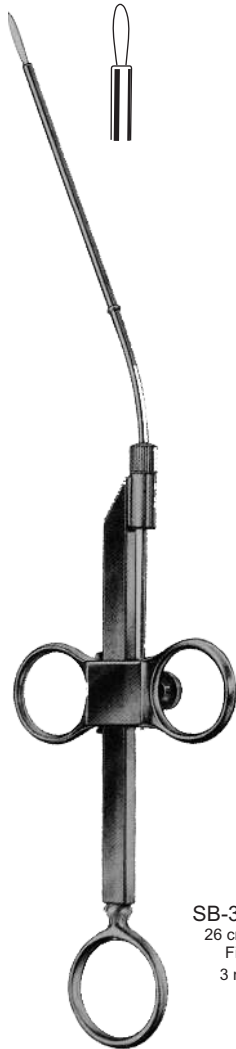

SB-3556-26
26 cm/10 1/4"
Fig.1
3 mm \varnothing

Krause

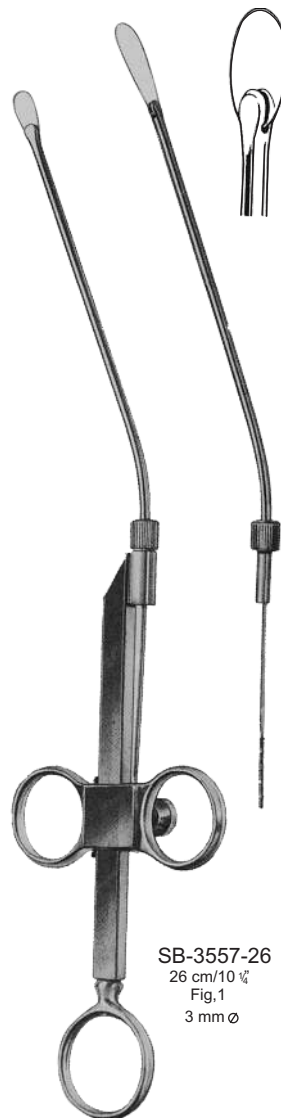

SB-3557-26
26 cm/10 1/4"
Fig.1
3 mm \varnothing

Krause-Voss



SB-3558-10
10,5 cm/4 1/8"
0,3 mm \varnothing

Rhinology Instruments

Nasal Tempon Forceps
Nasal Tempon Zange

Nasale Tempon Forceps
Pinza nasal Tempon



Troltsch
SB-3559-15
14,5 cm/5 3/4"



Troltsch
SB-3560-15
18 cm/7"



Grunwald (Jansen)
SB-3561-20
21,5 cm/8 1/2"



Lubet-Barbon
SB-3562-20
18,5 cm/7 1/4"

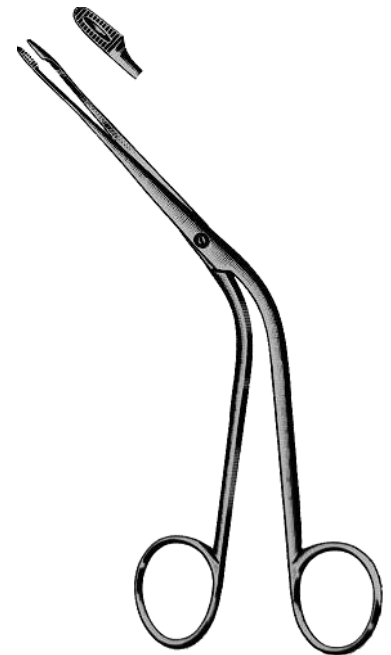

Hartmann
SB-3563-15
15 cm/6 "

Rhinology Instruments

Nasal Polypus Forceps, Septum Forceps
Nasenpolypen Pinzetten, Zangen Septum

Nasale Polypus, forceps septum
Pólipos nasales Pinzas, Pinzas Septum

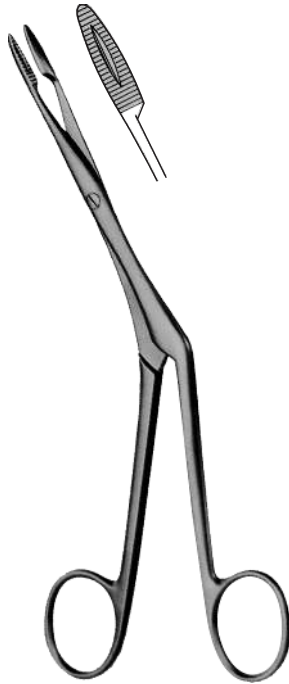

Hartmann
SB-3564-20
18,5 cm/7 ¼"

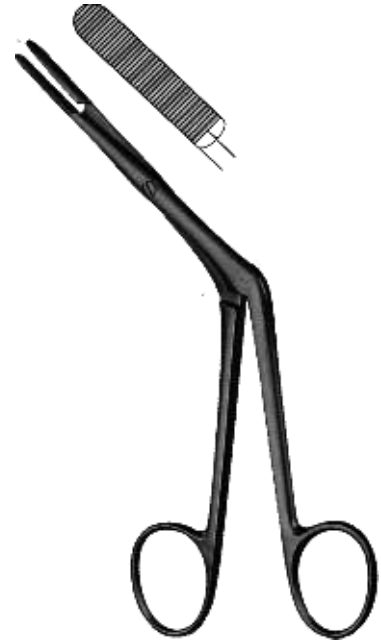

Killian
SB-3565-17
16 cm/6 ¼"



SB-3566-01

SB-3566-02 SB-3566-03

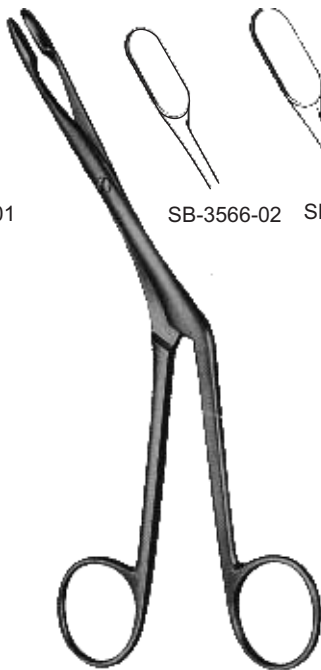

Heymann
SB-3566-18
18 cm/7 "



Knight
SB-3567-18
17 cm/6 ¾"

Rhinology Instruments

Septum Forceps, Ethmoid Bone Forceps
Septum Forceps, Ethmoid Knochenzange

Pince septum, pincas à os Ethmoid
Pinzas, Pinzas Septum Ethmoid hueso



SB-3568-01
16 cm/6 1/4"



SB-3568-02
16 cm/6 1/4"

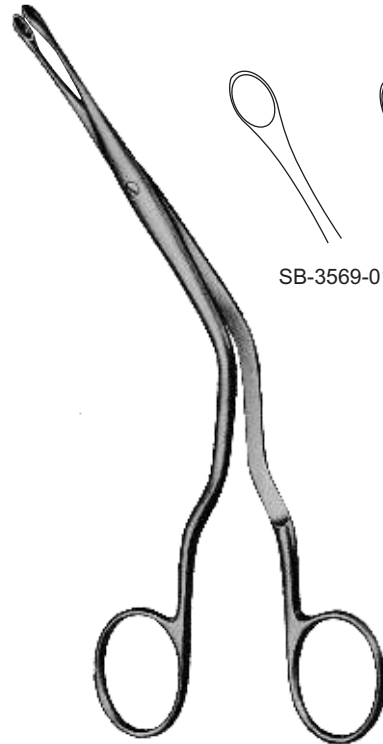

SB-3569-01

SB-3569-02

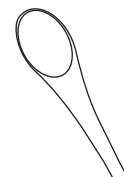
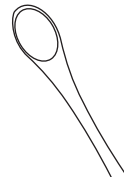

Luc
SB-3569-20
20 cm/8"



SB-3570-20
18,5 cm/7 1/4"
Fig.1



Luc



Brunings



SB-3571-01
16,5 cm/6 1/2"
Fig.1

SB-3571-02
16,5 cm/6 1/2"
Fig.2

SB-3571-03
16,5 cm/6 1/2"
Fig.3

SB-3571-04
16,5 cm/6 1/2"
Fig.4

Rhinology Instruments

Ethmoid Bone Forceps
Ethmoid Knochenzange

Ethmoid daviers
Ethmoid hueso Pinzas

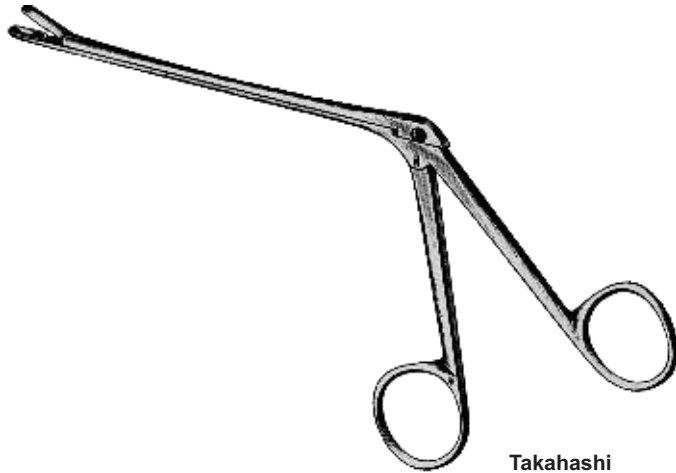

Takahashi

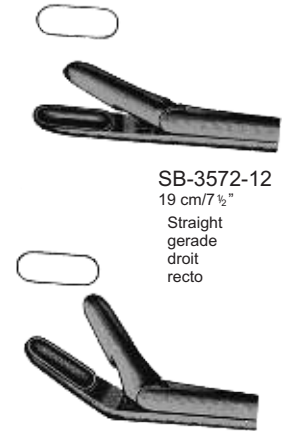

SB-3572-12
19 cm/7 1/2"
Straight
gerade
droit
recto

SB-3573-12
19 cm/7 1/2"
Bent Upwards
Bent Upwards
Bent Vers le haut
Bent Hacia arriba

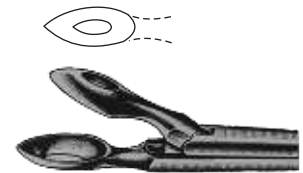
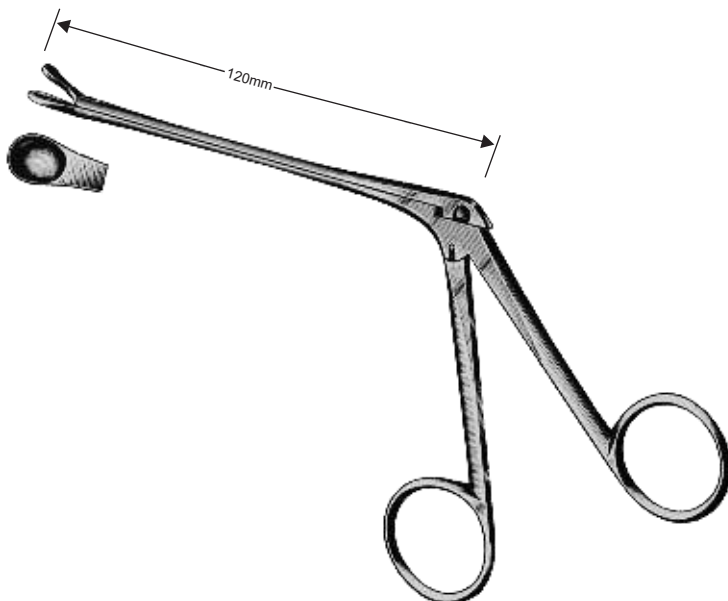

Weil
SB-3574-12
12 cm/4 3/4"
with neck
mit Hals
avec col
con cuello

Watson-Williams
SB-3575-12
19 cm/7 1/2"

Rhinology Instruments

Ethmoid Bone Forceps, Nasal Cutting Forceps
Ethmoid Knochenzange, Nasal Cutting Forceps

Daviers Ethmoid, les nasaux Forceps coupe
Ethmoid Pinzas de hueso, nasales Forceps de corte

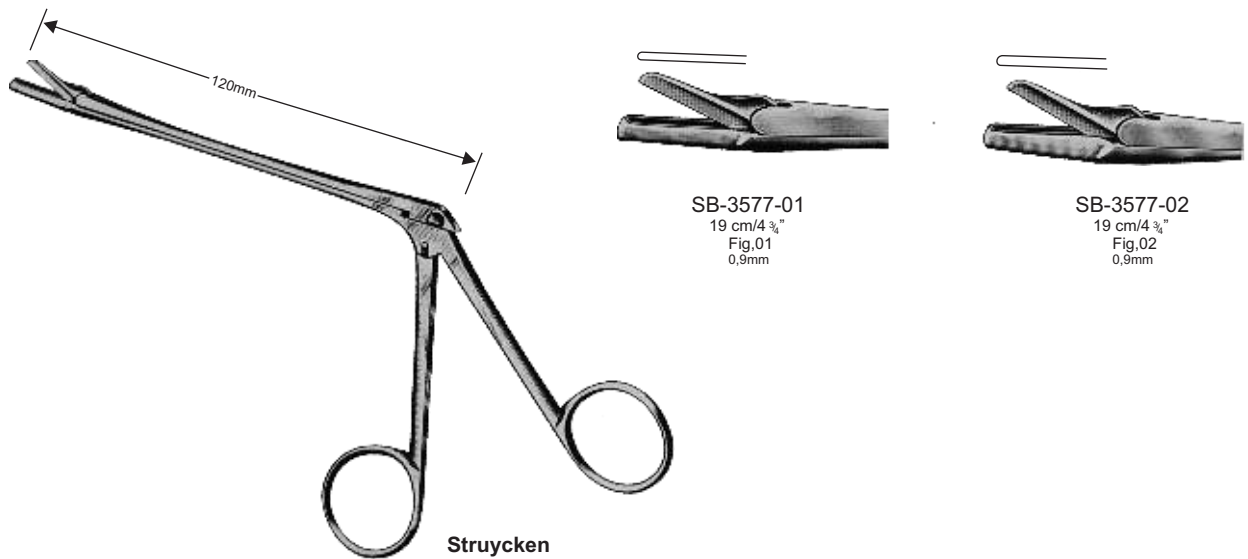
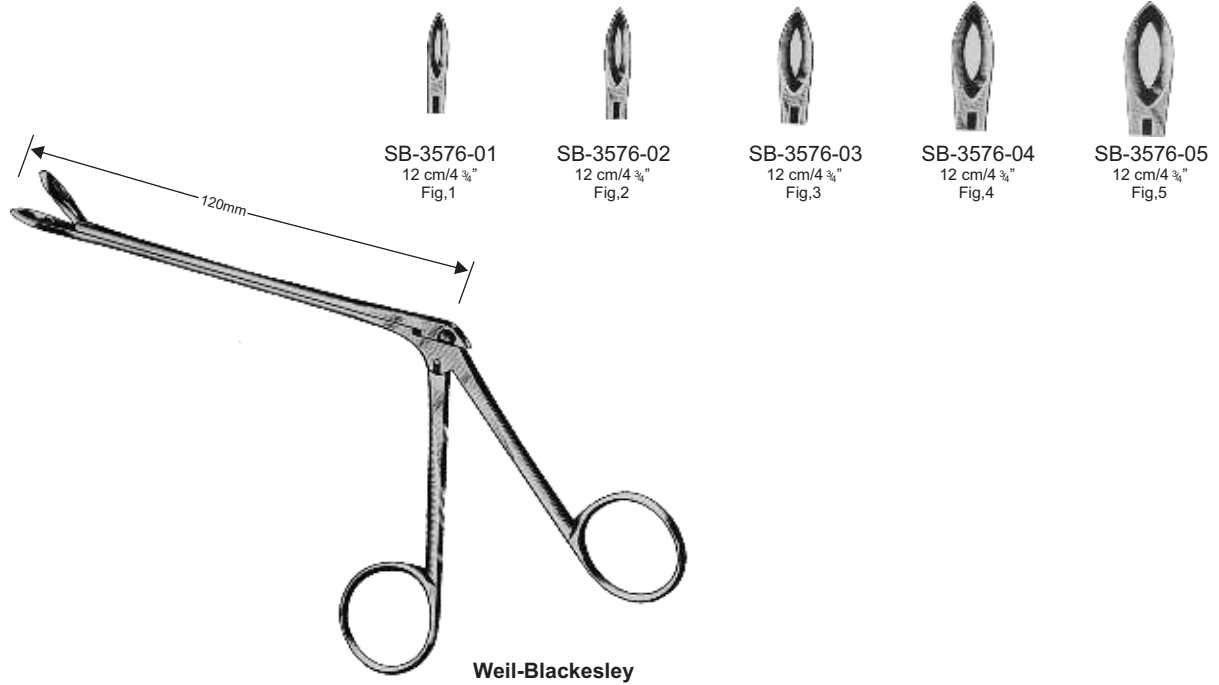

Rhinology Instruments

Sphenoid Bone Punches
Keilbein Punches

Poinçons os sphénoïde
Punzones de hueso esfenoides

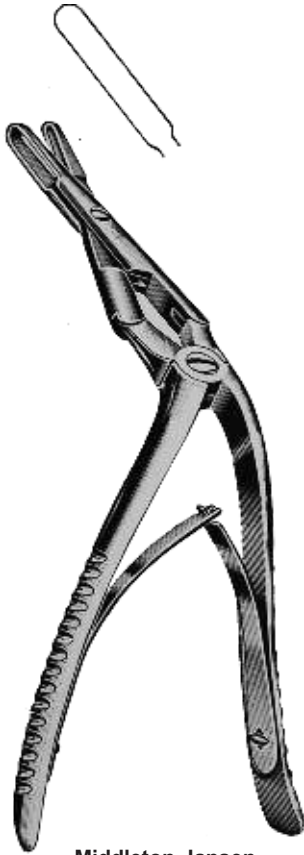

Middleton-Jansen
SB-3578-19
19 cm/7½"

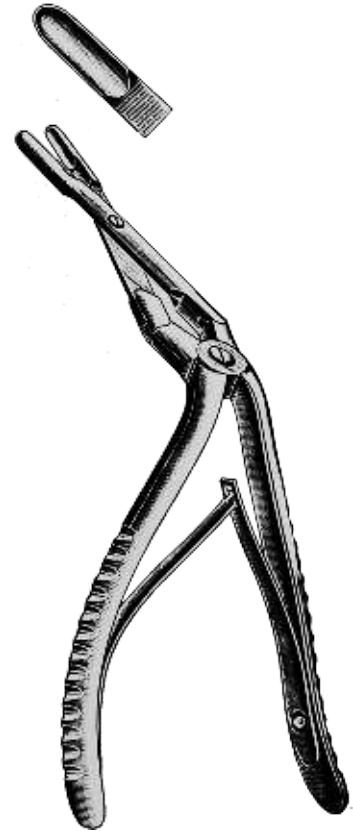

Middleton-Jansen
SB-3579-19
19 cm/7½"



Kazanjian
SB-3580-18
18 cm/7"

Rhinology Instruments

Sphenoid Bone Punches
Keilbein Punches

Poinçons os sphénoïde
Punzones de hueso esfenoides

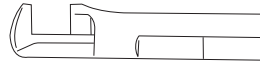
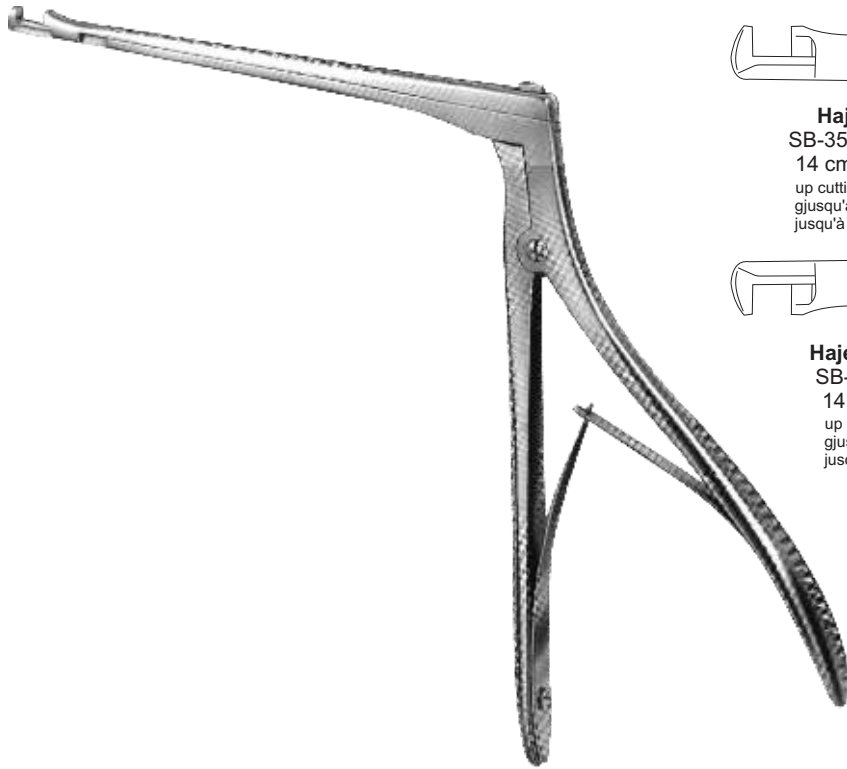

Hajek
SB-3581-13
14 cm/5 1/2"
up cutting
gjusqu'à la coupe
jusqu'à la coupe...



Hajek-Kofler
SB-3583-12
14 cm/5 1/2"
up cutting
gjusqu'à la coupe
jusqu'à la coupe...

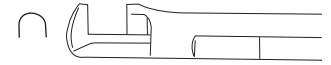

Hajek
SB-3582-18
14 cm/5 1/2"
down cutting
unten schneiden
à coupe descendante
tala

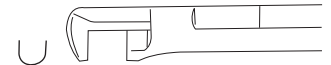

Hajek-Kofler
SB-3584-12
14 cm/5 1/2"
down cutting
unten schneiden
à coupe descendante
tala

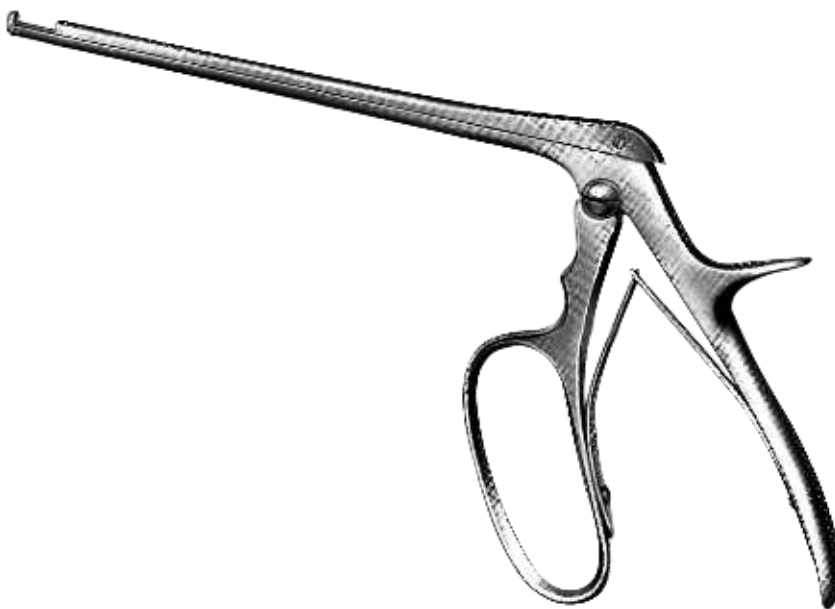

Ferris-Smith-Kerrison



SB-3585-17
18 cm/7 "
up cutting
gjusqu'à la coupe
jusqu'à la coupe...



SB-3586-17
18 cm/7 "
down cutting
unten schneiden
à coupe descendante
tala

Rhinology Instruments

Rhinoplastic Knives
rhinoplastischen Messer

Couteaux rhinoplastie
Cuchillos Rhinoplastic



Joseph



SB-3587-01
15 cm/6 "
Fig,1

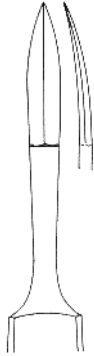

SB-3587-02
15 cm/6 "
Fig,2



Fomon



SB-3588-16
16,5 cm/6 1/2"



SB-3589-16
16 cm/6 1/4"



Converse



SB-3590-15
15 cm/6 "



Joseph



SB-3591-14
14 cm/5 1/2"



Cottle

Rhinology Instruments

Septum Knives, Swivel Knives
Septum Messer, Messer Swivel

Couteaux, Couteaux septum pivotantes
Cuchillos Septum, cuchillos giratorios

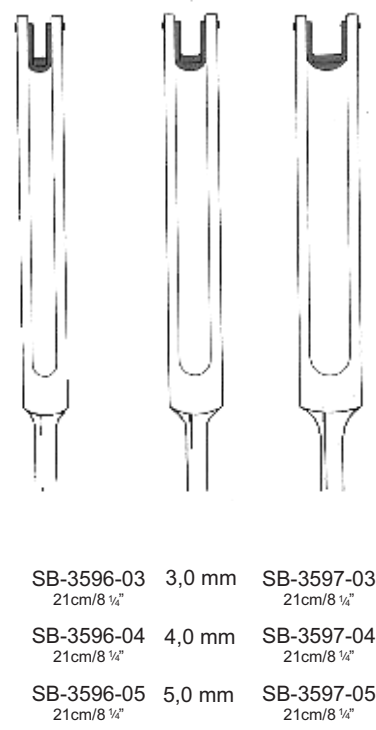
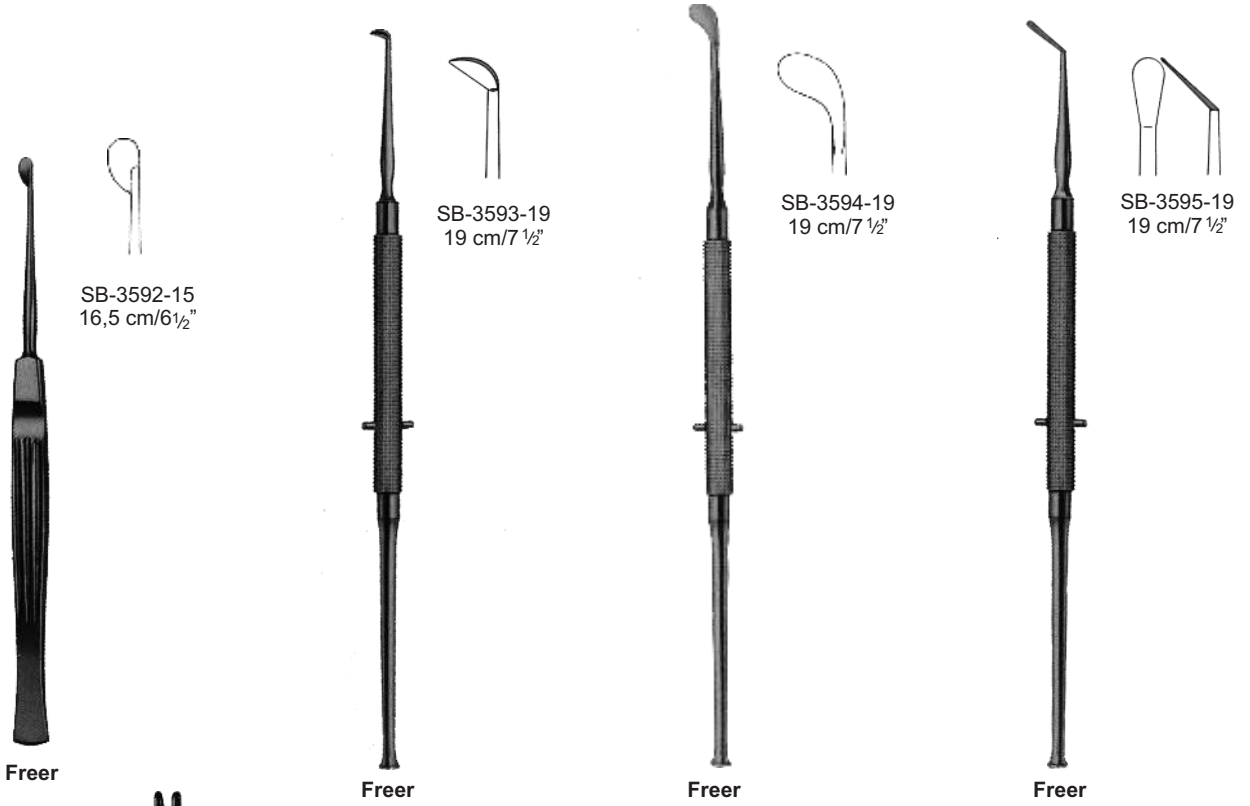

Rhinology Instruments

Septum Elevators
Septum Aufzüge

Ascenseurs septum
Elevadores septum



Mckenty

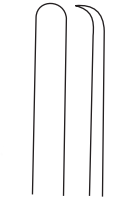

SB-3599-04
16 cm/6 "



SB-3599-05
16 cm/6 "



Joseph



SB-3600-16
16 cm/6 1/4"



Cottle
SB-3601-19
19.5 cm/7 1/2"



Freer



SB-3602-19
19 cm/7 1/2"
5mm



Freer



SB-3603-19
19 cm/7 1/2"
6mm



Freer



SB-3604-18
18.5 cm/7 "
5/5 mm



Freer

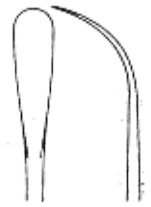

SB-3605-20
20.5 cm/8 "
6/5 mm



Rhinology Instruments

Septum Elevators
Septum Aufzüge

Ascenseurs septum
Elevadores septum

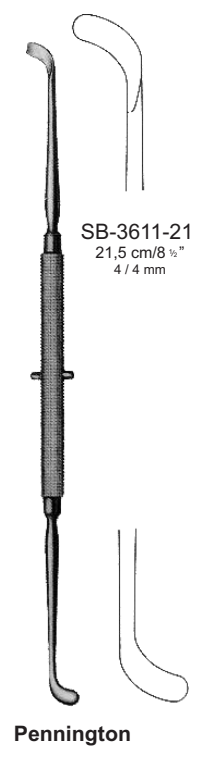
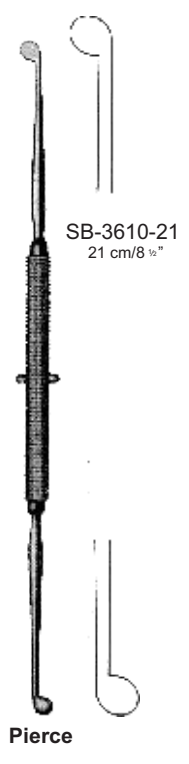
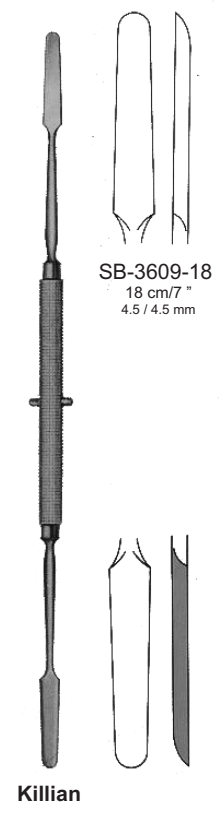
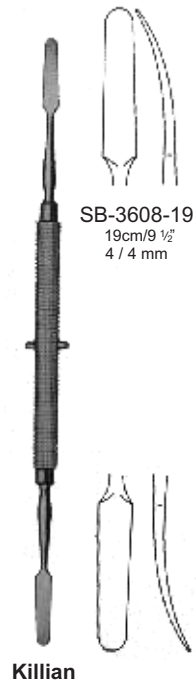
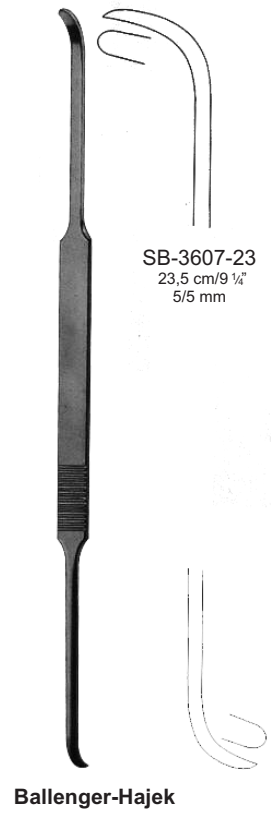
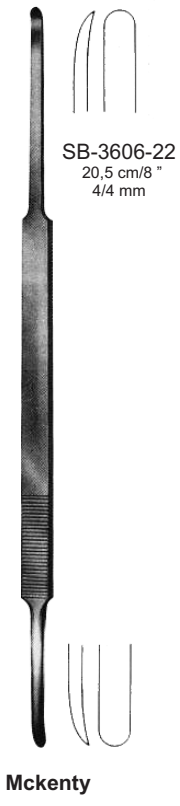

Rhinology Instruments

Periosteal Elevators & Septum Chisels
Periosteal Elevators & Septum Meißel

Ascenseurs Periosteel et burins septum
Elevadores Periosteel y cinceles Septum



SB-3612-22
19,5 cm/8 1/2"
4 / 4 mm

Roger

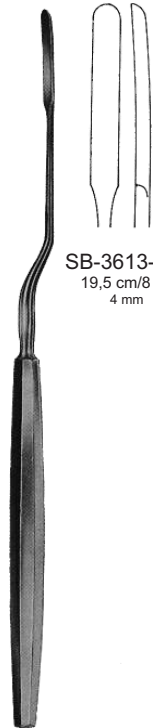

SB-3613-22
19,5 cm/8 1/2"
4 mm

Joseph-Masing



SB-3614-23
23 cm/9 "
3.3 / 3.7 mm

Cottle



SB-3615-21
21,5 cm/7 1/2"
3 / 2 mm

Masing

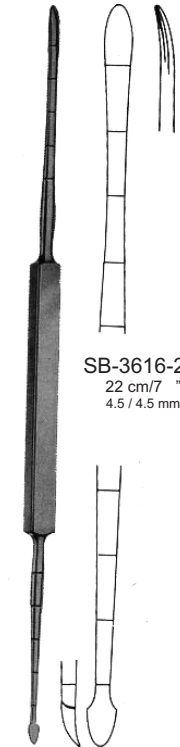

SB-3616-21
22 cm/7 "
4.5 / 4.5 mm

Cottle



SB-3617-22
22 cm/7 "
6.5 mm

Joseph



SB-3618-16
16 cm/6 1/2"
4 mm

Freer



SB-3619-17
16,5 cm/6 1/2"
4 mm

Freer



Freer
SB-3620-15
15 cm/6"
6 mm

Rhinology Instruments

Septum Knives, Swivel Knives
Septum Messer, Messer Swivel

Couteaux, Couteaux septum pivotantes
Cuchillos Septum, cuchillos giratorios

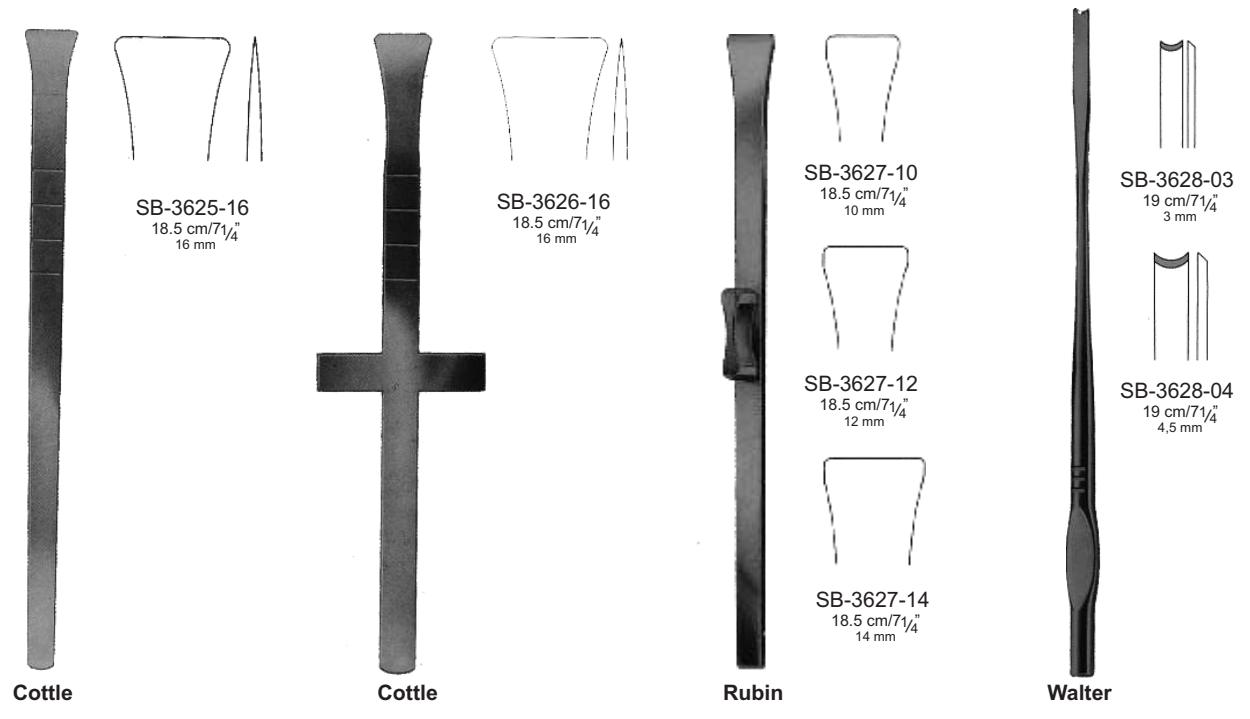
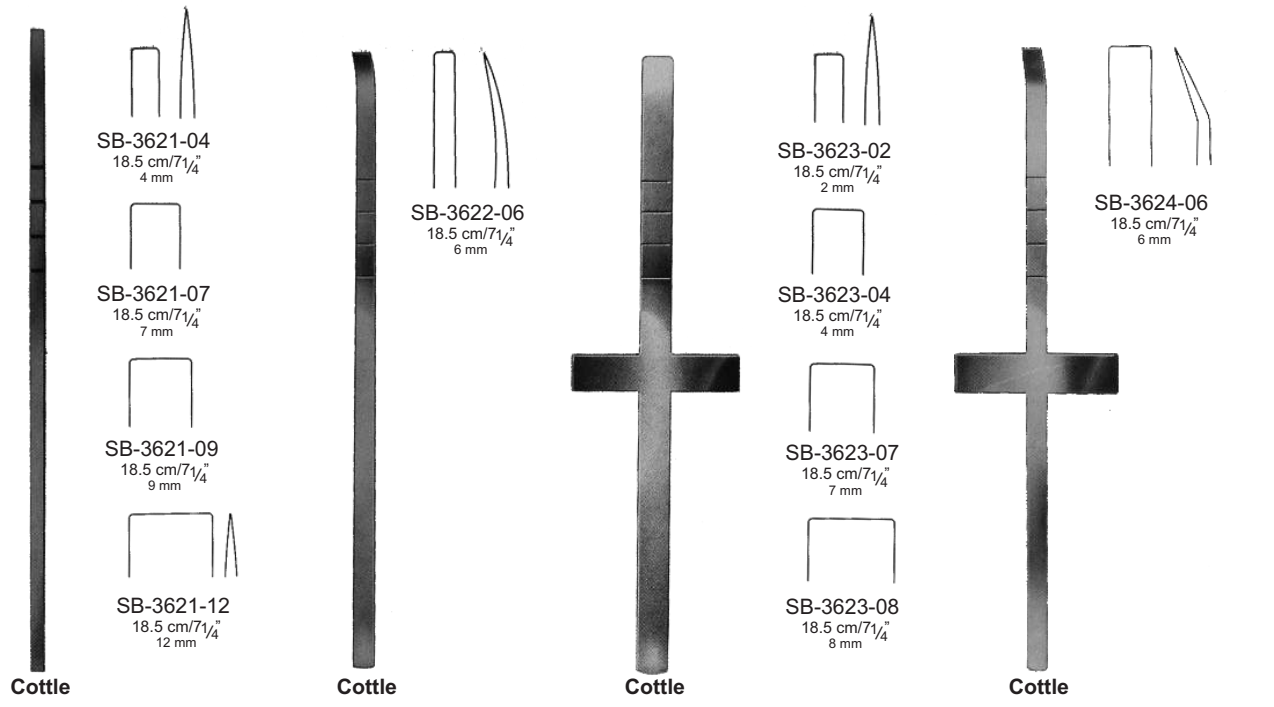

Rhinology Instruments

Septum Gouges
Septum Gouges

Gouges septum
Gouges septum



Ballenger



SB-3629-02
15 cm/6"
2 mm



SB-3629-04
15 cm/6"
4 mm



SB-3629-06
15 cm/6"
6 mm



SB-3629-08
15 cm/6"
8 mm



Killian



SB-3630-16
16 cm/6 $\frac{1}{4}$ "
5 mm

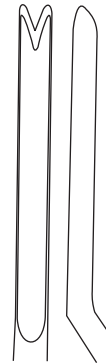

SB-3631-16
16 cm/6 $\frac{1}{4}$ "
5 mm



Killian-Claus

Rhinology Instruments

Osteotomes, Gouges, Chisels

Osteotome, Hohlmeißel, Flachmeißel

Ostéotomes, gouges, ciseaux

Osteotomos, gubias, cinceles



Walter



Fomon

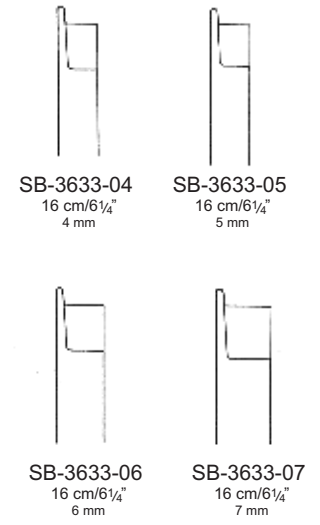

Cinelli

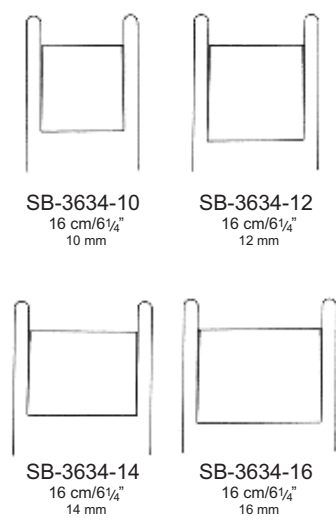

Rhinology Instruments

Rhinoplastic Chisels, Osteotomes, Nasal Saws
Rhinoplastischen Flachmeißel, Osteotome, Nasal Sägen

Ciseaux rhinoplastie, ostéotomes, scies nasaux
Cinceles Rhinoplastic, los osteotomos,
Sierras nasales

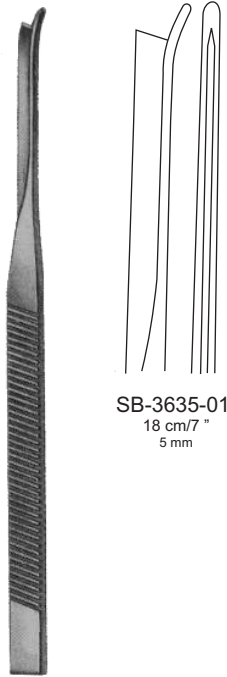

Silver

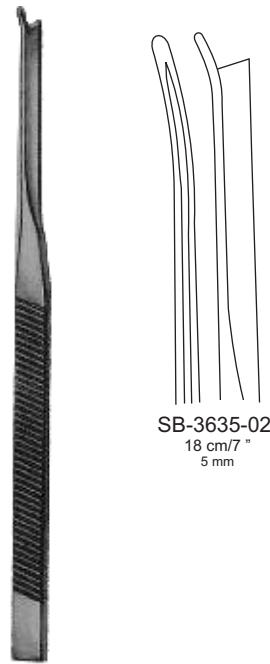

Silver



Silver

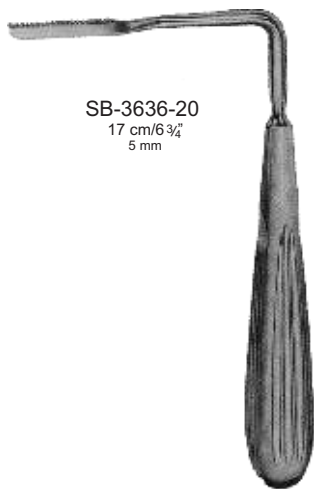

Joseph

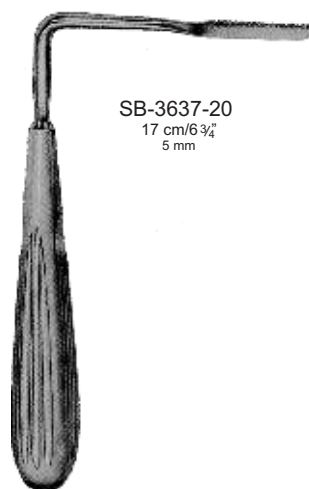

Joseph



SB-3638-00
19 cm/7 1/2"

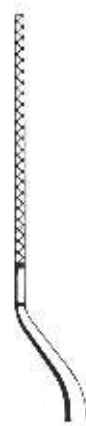

SB-3638-01 SB-3638-02
19 cm/7 1/2" 19 cm/7 1/2"

Rhinology Instruments

Nasal Resps, Bone File Antrum Rasps
Nasal RESPS, Bone Datei Antrum Raspeln

Resps nasale, Râpes os de fichiers Antre
PRAE nasal, hueso Escofinas antro de archivos

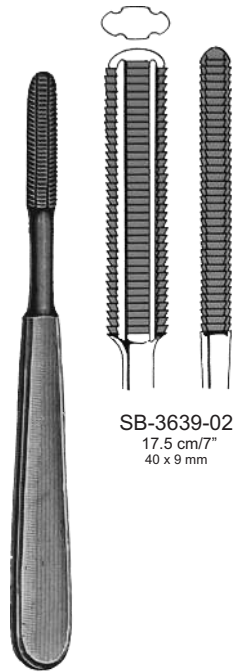

SB-3639-02
17.5 cm/7"
40 x 9 mm

Maltz

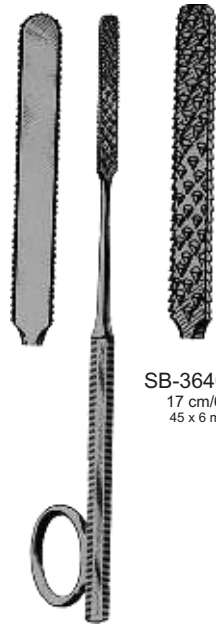

SB-3640-01
17 cm/6 3/4"
45 x 6 mm

Gallaher



SB-3640-02
17 cm/6 3/4"
45 x 6 mm



SB-3640-03
17 cm/6 3/4"
45 x 6 mm

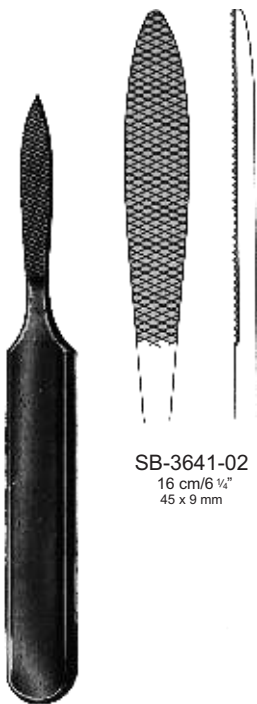

SB-3641-02
16 cm/6 1/4"
45 x 9 mm

Joseph



Cottle

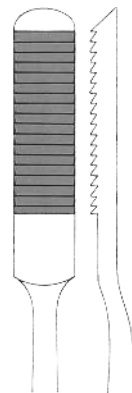

SB-3642-21
20.5 cm/8"
30 x 8 mm



Aufricht



SB-3643-21
21 cm/8 1/4"
32 x 9 mm



SB-3644-21
21 cm/8 1/4"
32 x 9 mm

Rhinology Instruments

Glabella & Nasal Rasps
Glabella Nasal & Raspeln

Râpes glabelle et nasale
Glabela y nasal Escofinas



Lewis



SB-3645-18
19 cm/7 1/2"
15 x 8 mm



SB-3646-18
19 cm/7 1/2"
15 x 8 mm



Wiener



SB-3647-18
18 cm/7"



SB-3648-18
18 cm/7"



Fomon

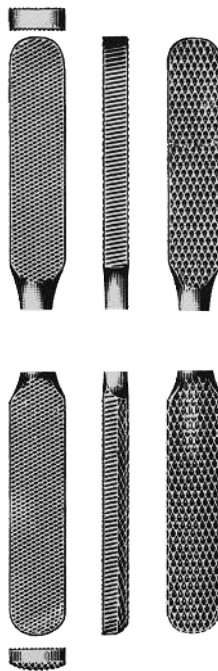

SB-3649-21
21 cm/8 1/4"

Rhinology Instruments

Nasal Rasps
nasal Raspeln

Râpes nasaux
Escofinas nasales

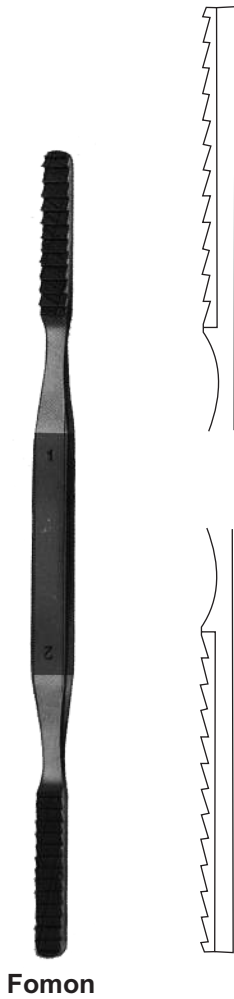

Fomon

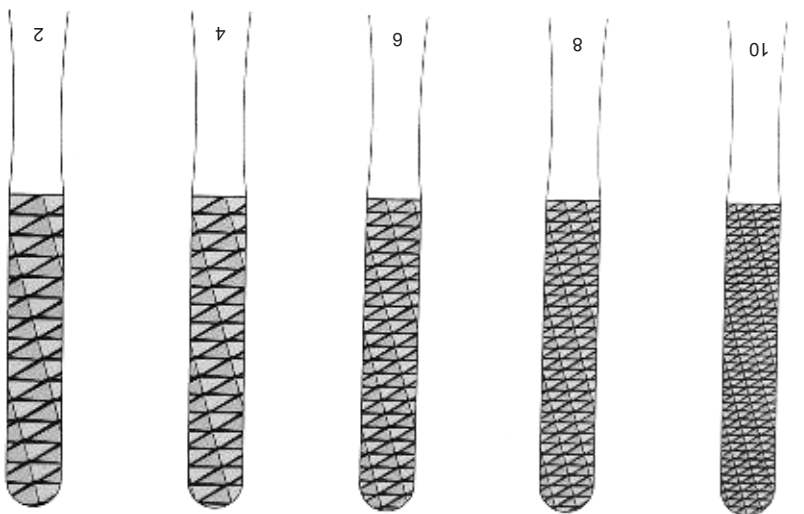
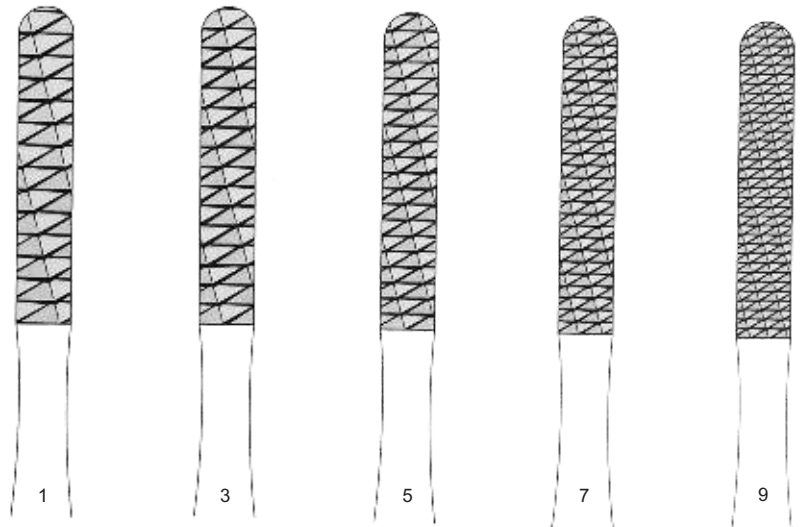

SB-3650-01
20.5 cm/8"
Fig. 1/2
30 x 8 mm

SB-3650-02
20.5 cm/8"
Fig. 3/4
40 x 7 mm

SB-3650-03
20.5 cm/8"
Fig. 5/6
40 x 7 mm

SB-3650-04
20.5 cm/8"
Fig. 7/8
40 x 7 mm

SB-3650-05
20.5 cm/8"
Fig. 9/10
40 x 7 mm

Rhinology Instruments

Nasal Hooks, Nasal Retractors, Mucose Hooklets

Nasale Crochets, écarteurs nasaux, petits crochets mucose

Nasal Haken, Retraktoren Nasal, Schleimhäute Häkchen

Ganchos nasal, retractores nasales, mucosa ganchillos



Joseph
SB-3651-15
15.5 cm/6"



Cottle
SB-3652-16
17 cm/6¾"



Cottle



SB-3653-01
14.5 cm/5¾"



SB-3653-02
14.5 cm/5¾"



SB-3653-03
14.5 cm/5¾"



Fomon
SB-3654-17
17 cm/6¾"



Lange
SB-3655-23
23 cm/9"



Africht
SB-3656-19
19 cm/7½"



Kilner
SB-3657-08
8 cm/3¼"



Converse
SB-3658-12
11.5 cm/4½"

Rhinology Instruments

Alar Hooklets, Nasal Retractors
Alar Häkchen, Nasal Retraktoren

Petits crochets Alar, Rétracteurs nasaux
Alar ganchillos, Retractores nasales



Joseph



SB-3659-02
16.5 cm/6½"
2 mm



SB-3659-05
16.5 cm/6½"
5 mm



SB-3659-07
16.5 cm/6½"
7 mm



SB-3659-10
16.5 cm/6½"
10 mm



Fomon



SB-3660-16
16 cm/6¼"



Cottle-Neivert
SB-3661-20
19.5 cm/7 ¼"

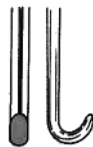

Cottle



SB-3662-14
14.5 cm/5¾"



SB-3663-01
14.5 cm/5¾"



SB-3663-02
14.5 cm/5¾"

Rhinology Instruments

Alar Hooklets, Nasal Retractors
Alar Hakchen, Nasal Retraktoren

Petits crochets Alar, Retracteurs nasaux
Alar ganchillos, Retractores nasales



Cottle
SB-3664-14
14 cm/5½"



Cottle
SB-3665-16
17 cm/6¾"



Cottle
SB-3666-15
14 cm/6½"



Cottle
SB-3667-15
16 cm/6¼"



Aufricht
SB-3668-14
12 cm/4¾"

Rhinology Instruments

Septum Forceps, Septum Straightening Forceps
Septum Pinzetten, Zangen Septum Aufrichtung

Pince septum, Forceps à dresser septum
Pinzas, Pinzas Septum Septum Alisar



Cottle-Walsham



SB-3669-01
23 cm/9"



SB-3669-02
23 cm/9"



SB-3669-03
23 cm/9"



Asch

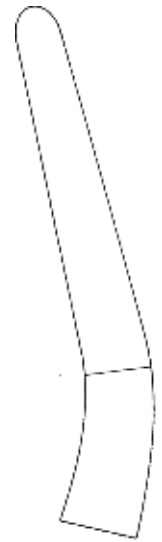

SB-3670-23
22.5 cm/8 3/4"



Kressner
SB-3671-20
21 cm/8 1/4"



Rubin
SB-3672-20
20 cm/8"

Rhinology Instruments

Skin Grasping Forceps
Haut Faßzange

Pince à préhension de la peau
Pinzas de agarre de la piel



Ogura
SB-3673-11
11 cm/4 1/4"



SB-3674-14
14 cm/5 1/2"
1.7 mm
wide with teeth
breit mit Zähnen
largeur des dents
de ancho con dientes

Cottle



SB-3675-11
11 cm/4 1/4"
12 mm wide
wide
breite
large
ancho

Cottle

Rhinology Instruments

Adenoid Currettes
adenoid Küretten

adénoïde Currettes
adenoides Curetas



Coakly
17 cm / 6 3/4"



SB-3676-01



SB-3676-02



SB-3676-03



SB-3676-04



SB-3676-05



SB-3676-06



Beckmann
SB-3677-01 - SB-3677-06



Beckmann
SB-3678-01 - SB-3678-06



SB-3677-01
22.5 cm / 8 3/4"
Fig. 1
13 mm



SB-3677-02
22.5 cm / 8 3/4"
Fig. 2
15 mm



SB-3677-03
22.5 cm / 8 3/4"
Fig. 3
17 mm



SB-3678-01
22 cm / 8 3/4"
Fig. 1
13 mm

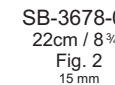

SB-3678-02
22cm / 8 3/4"
Fig. 2
15 mm

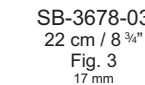

SB-3678-03
22 cm / 8 3/4"
Fig. 3
17 mm



SB-3677-04
22.5 cm / 8 3/4"
Fig. 1
19 mm



SB-3677-05
22.5 cm / 8 3/4"
Fig. 2
21 mm



SB-3677-06
22.5 cm / 8 3/4"
Fig. 3
23 mm

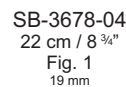

SB-3678-04
22 cm / 8 3/4"
Fig. 1
19 mm

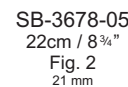

SB-3678-05
22cm / 8 3/4"
Fig. 2
21 mm

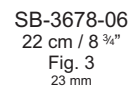

SB-3678-06
22 cm / 8 3/4"
Fig. 3
23 mm

Rhinology Instruments

Suction Rasparatory
Saug Rasparatory

Rasparatory aspiration
succión Rasparatory



Guilen

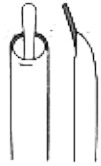

SB-3679-20
19 cm / 7 1/2"



Elcken - Killian
SB-3680-03
3 mmø



Ritter - Halle
SB-3681-25 2.5 mm
SB-3681-30 3.0 mm
SB-3681-40 4.0 mm



Serving Health Care

SPEED BIRD

ENTERPRISES



**161/C, SMALL INDUSTRIAL ESTATE
SIALKOT-51310, (PAKISTAN)**



: +92-304 0549944



: +92-52-3555584



: speed@birddent.com



: www.birddent.com