

Serving Health Care

SPEED BIRD
ENTERPRISES

www.birddent.com

OPHTHALMOLOGY INSTRUMENTS

SECTION

21

Ophthalmology Instruments

Eye Speculas
Eye Speculas

Speculas Eye
especulos de ojos



Weiss
SB-2962-07
7 cm/2¾"
Children
Kinder
enfants
niños

SB-2963-09
9 cm/3½"
Adults
Erwachsene
Adultes
Adultos



Weiss
SB-2964-07
7 cm/2¾"
Children
Kinder
enfants
niños

SB-2965-09
9 cm/3½"
Adults
Erwachsene
Adultes
Adultos



Park-Guyton
SB-2966-08
8 cm/3¼"



Park-Maumenee
SB-2967-08
8 cm/3¼"



Park
SB-2968-08
8 cm/3¼"

Ophthalmology Instruments

Eye Speculas
Eye Speculas

Speculas Eye
especúlos de ojos

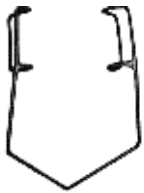

Children **Barraquer (Colibri)** Adults
SB-2969-03 SB-2969-04
3 cm/1¼" 4 cm/1½"



Bowman
SB-2970-07
7 cm/2¾"



Sauer
SB-2971-03
3 cm/1¼"



Goldstein
SB-2972-03
3 cm/1¼"

For left eye
Für das linke Auge
Pour l'œil gauche
Para el ojo izquierdo

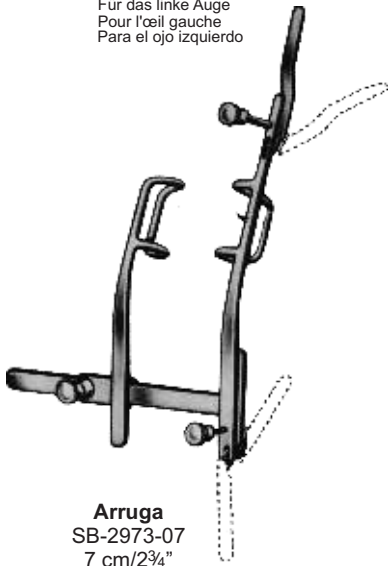

Arruga
SB-2973-07
7 cm/2¾"

For right eye
Für das rechte Auge
Pour l'œil droit
Para el ojo derecho

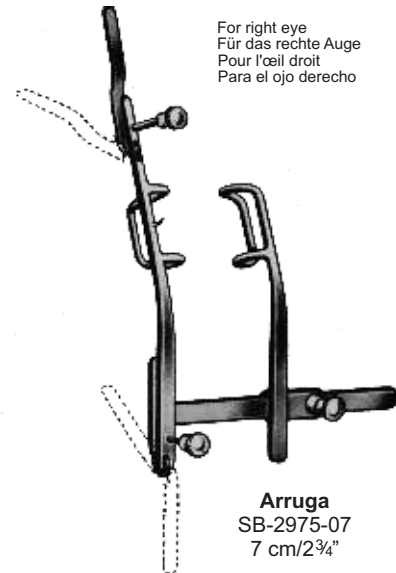

Arruga
SB-2975-07
7 cm/2¾"



Mellinger-Axenfeld
SB-2974-07
7 cm/2¾"

Ophthalmology Instruments

Eye Speculas
Eye Speculas

Speculas Eye
especulos de ojos



Mellinger-Axenfeld
SB-2976-07
7 cm/2 3/4"



Mellinger
SB-2977-05
5 cm/2"
Children
Kinder
enfants
niños

SB-2977-07
7 cm/2 3/4"
Adults
Erwachsene
Adultes
Adultos



Mellinger Beard
SB-2978-05
5 cm/2"
Children
Kinder
enfants
niños

SB-2978-07
7 cm/2 3/4"
Adults
Erwachsene
Adultes
Adultos

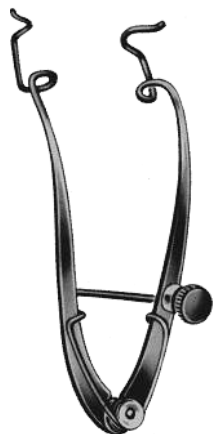

Knapp Clark
SB-2979-08
8 cm/3 1/4"



Graefe
SB-2980-06
6 cm/2 1/2"
Children
Kinder
enfants
niños

SB-2980-09
9 cm/3 1/2"
Adults
Erwachsene
Adultes
Adultos



Cook
SB-2981-04
4 cm/1 1/2"
Children
Kinder
enfants
niños

SB-2981-05
5 cm/2"
Adults
Erwachsene
Adultes
Adultos



Lancaster
SB-2982-08
8 cm/3 1/4"



Williams
Children
SB-2983-07
7 cm/2 3/4"
Children
Kinder
enfants
niños

Adults
SB-2983-08
8 cm/3 1/4"
Adults
Erwachsene
Adultes
Adultos



Lister-Burch
SB-2984-08
8 cm/3 1/4"

Ophthalmology Instruments

Eye Speculas
Eye Speculas

Speculas Eye
especúlos de ojos



Weiss
SB-2985-08
8 cm/3¼"



Murdock
SB-2986-05
5 cm/2"

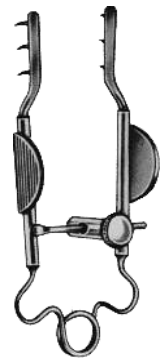

Mueller
SB-2987-07
7 cm/2¾"



Critchett
SB-2988-06
6 cm/2½"



Castroviejo
SB-2989-08
8 cm/3¼"



Stevenson
SB-2990-07
7 cm/2¾"



Agricola
SB-2991-04
4 cm/1½"

Ophthalmology Instruments

Eye Lasek
Eye Lasek

Eye Lasek
ojo de Lasek



Flap Repositor
SB-2992-60



Micro-Hoe and Epi-Peeler
SB-2993-62



Trepine 8 mm
Alcohol wel 9.5 mm
SB-2994-64

Ophthalmology Instruments

Eye Instruments
Eye Instruments

Instruments Eye
Instrumentos de ojos

Also Available in Titanium
Auch in Titan
Aussi disponible en titane
También Disponible en Titanio



Lewicky
SB-2995-66
Lens Manipulator



Kuglen
SB-2996-68/S
SB-2996-68/A
Iris Hook & lens
Manipulator Push
Pull model



Bechert
SB-2997-01 7mm
SB-2997-02 9mm



Lesten
SB-2998-0S
SB-2998-0A



Kuglen
SB-2999-0S
SB-2999-0A



Sinskey
SB-3000-0S
SB-3000-0A

Ophthalmology Instruments

Eye Instruments
Eye Instruments

Instruments Eye
Instrumentos de ojos

Also Available in Titanium
Auch in Titan
Aussi disponible en titane
También Disponible en Titanio



Nucleus sustainer
SB-3001-78



Lieberman
SB-3002-80



Koch
SB-3003-80



Fukasaku
SB-3004-84



Magahara
SB-3005-86



Rosen
SB-3006-88

Ophthalmology Instruments

Eye Instruments
Eye Instruments

Instruments Eye
Instrumentos de ojos

Also Available in Titanium
Auch in Titan
Aussi disponible en titane
También Disponible en Titanio



Castroviejo
SB-3007-90
0.12 mm Teeth



Harms
SB-3008-00
0.12 mm Teeth



Barraquer
SB-3009-02
0.12 mm Teeth



Castroviejo
SB-3010-04
0.12 mm Teeth



Castroviejo
SB-3011-06
0.12 mm Teeth
0.3 mm Teeth



Bishop-Harmon
SB-3012-0A
Iris Forceps 1 x 2
Teeth, 0.3 mm

Ophthalmology Instruments

Eye Instruments

Instruments Eye

Instrumentos de ojos

Eye Instruments

Also Available in Titanium

Auch in Titan

Aussi disponible en titane

También Disponible en Titanio



O'Gawa
SB-3013-0S
SB-3013-0C

Straight
gerade
droit
recto

Curved
Gebogene
courbe
Curvo



Harms-Jaffe
SB-3014-0S
SB-3014-0C

Straight
gerade
droit
recto

Curved
Gebogene
courbe
Curvo



Bechert-Mc Pherson
SB-3015-14
11 mm



Kelman-Mc Pherson
SB-3016-16
8 mm

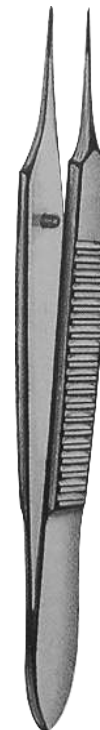

Mc Pherson
SB-3017-18



Mc Pherson
SB-3018-20
Corneal Forceps,
1 x 2 Teeth

Ophthalmology Instruments

Eye Instruments
Eye Instruments

Instruments Eye
Instrumentos de ojos

Also Available in Titanium
Auch in Titan
Aussi disponible en titane
También Disponible en Titanio

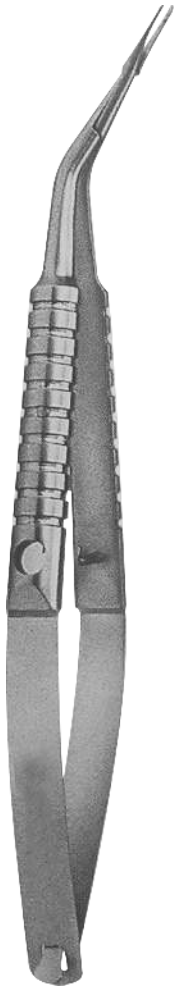

Fine
SB-3019-22
Inserting Forceps



Steinert
SB-3020-24
Universal Folding Forceps



IOL Insertin Forceps
SB-3021-26
SB-3021-27

with lock without lock
mit Schloss ohne Schloss
avec serrure sans serrure
con cerradura sin cerradura



Livernois
SB-3022-29
iol Holding Forceps



Livernois
SB-3023-31
iol Holding and
Folding Forceps

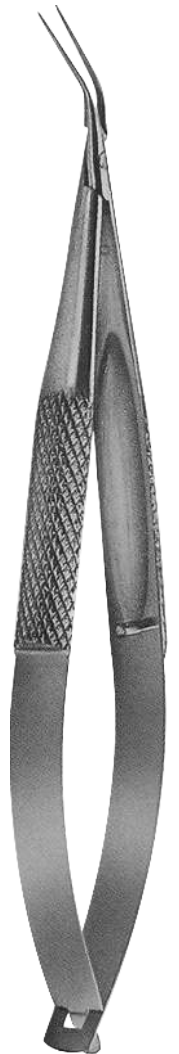

Blaydes
SB-3024-33
iol Inserting
Forceps

Ophthalmology Instruments

Eye Instruments
Eye Instruments

Instruments Eye
Instrumentos de ojos

Also Available in Titanium
Auch in Titan
Aussi disponible en titane
También Disponible en Titanio

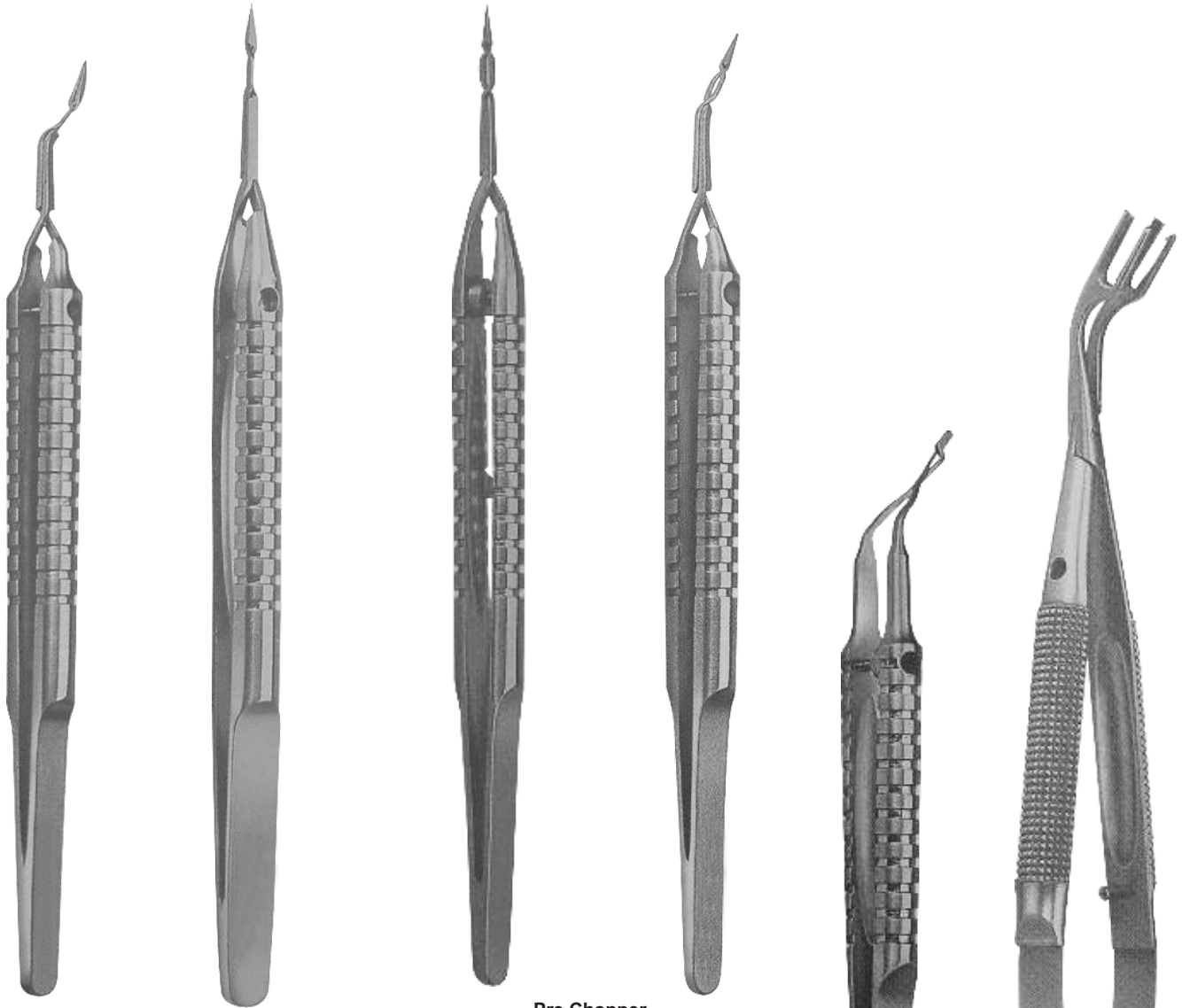

**Pre Chopper for
Soft Cataracts**

SB-3025-S
SB-3025-C
SB-3025-A

Straight
gerade
droit
recto

Curved
Gebogene
courbe
Curvo

Angled
Angled
incliné
angular

Pre Chopper
SB-3026-S
SB-3026-A

Straight
gerade
droit
recto

Curved
Gebogene
courbe
Curvo

Arnest
SB-3027-39

Koch
SB-3028-41
Universal Lens Folder

Ophthalmology Instruments

Eye Instruments
Eye Instruments

Instruments Eye
Instrumentos de ojos

Also Available in Titanium
Auch in Titan
Aussi disponible en titane
También Disponible en Titanio

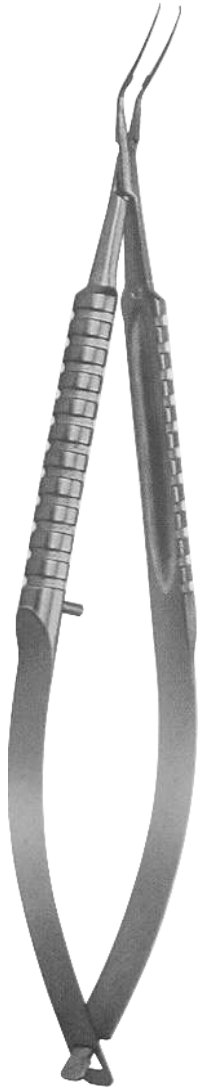

Utrata
SB-3029-43
Capsulorhexis Forceps
Systotome Tip
Systotome Tip
Systotome Conseil
Systotome Consejo
11 mm



Utrata
SB-3030-45
Capsulorhexis Forceps
Systotome Tip
Systotome Tip
Systotome Conseil
Systotome Consejo
11 mm



Masket
SB-3031-47
Capsulorhexis Forceps
Systotome Tip
Systotome Tip
Systotome Conseil
Systotome Consejo
11 mm



Utrata
SB-3032-49
Capsulorhexis Forceps
Systotome Tip
Systotome Tip
Systotome Conseil
Systotome Consejo
11 mm



Utrata
SB-3033-51
Capsulorhexis Forceps
Systotome Tip
Systotome Tip
Systotome Conseil
Systotome Consejo
11 mm

Ophthalmology Instruments

Eye Instruments
Eye Instruments

Instruments Eye
Instrumentos de ojos

Also Available in Titanium
Auch in Titan
Aussi disponible en titane
También Disponible en Titanio

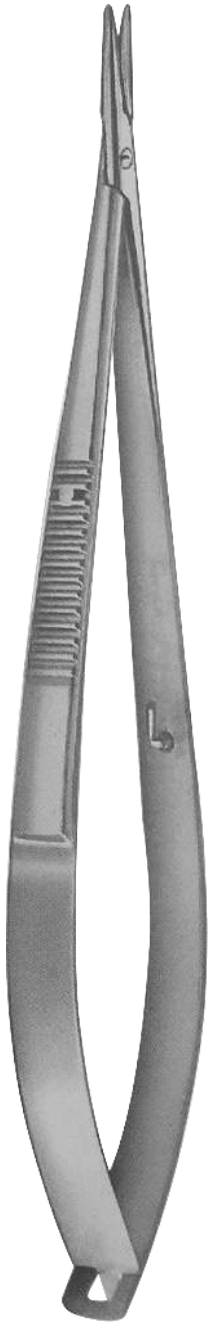

Castroviejo
SB-3034-A
SB-3034-B
Needle Holder

with lock
mit Schloss
avec serrure
con cerradura

without lock
ohne Schloss
sans serrure
sin cerradura

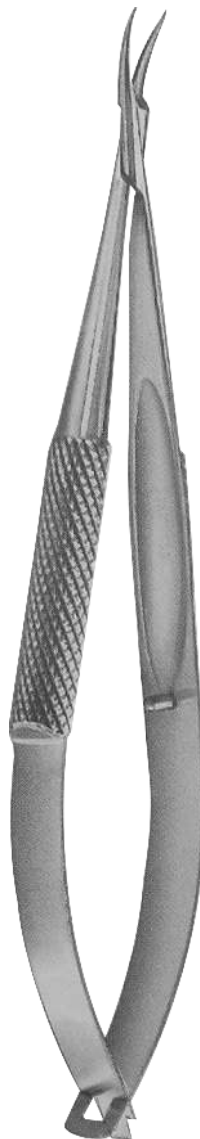

Barraquer
SB-3035-CB
Needle Holder

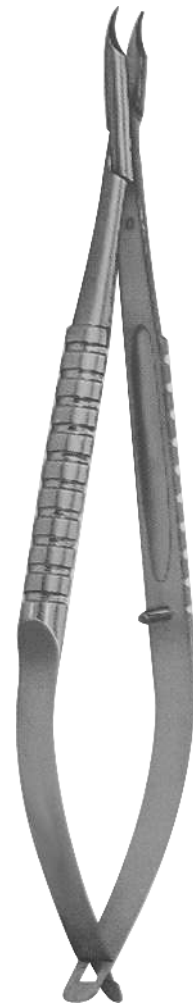

Micro Needle Holder
SB-3036-57

Ophthalmology Instruments

Vitreoretinal Instruments
Vitreoretinal Instruments

Instruments Vitreoretinal
Instrumentos Vitreoretinal



Retinal Membrane
SB-3037-59



Retinal Spatula
SB-3038-61
Triangular Tip
dreieckige Spitze
Astuce triangulaire
Consejo triangular
0.5 mm



Retinal Spatula
SB-3039-63
Triangular Tip
dreieckige Spitze
Astuce triangulaire
Consejo triangular
0.5 mm



SB-3040-65
Membrane Peeler



SB-3041-67
Membrane Spatula
Hooked

Ophthalmology Instruments

Rk/Prk/Lasik Instruments
Rk / PRK / Lasik Instruments

Rk / PRK / Lasik Instruments
Rk / PRK / Instrumentos de Lasik

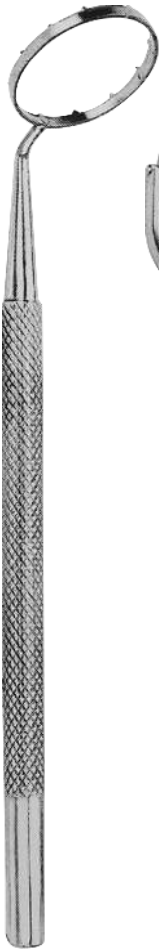

Thornton
SB-3042-69



Fine-Thornton
SB-3043-A 13mm
SB-3043-B 16mm



Hafmann Thornton
SB-3044-C 13mm
SB-3044-D 16mm



Globe Fixation Ring
SB-3045-75
12mm



Atraumatic Phaco
SB-3046-77
12mm



Atraumatic Phaco
SB-3047-79
12mm Inside
16mm Outside

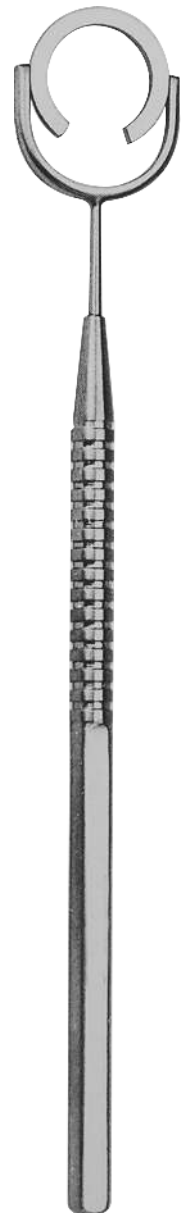

Ophthalmology Instruments

Rk/Prk/Lasik Instruments
Rk / PRK / Lasik Instruments

Rk / PRK / Lasik Instruments
Rk / PRK / Instrumentos de Lasik



Paton
SB-3048-81



Fukasaku
SB-3049-83
Lasik Spatula



Hocky Knife
SB-3050-85



Lasik
SB-3051-87

Flat Spatula for eleveting
the flap on one end
Flache Spatel für eleveting die
Klappe an einem Ende
Spatule plate pour eleveting le
rabat sur une extrémité
Espátula Piso en eleveting la
solapa en uno de los extremos

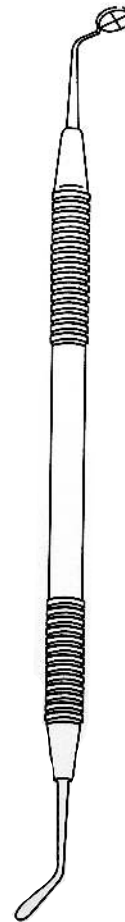

Pettigrove
SB-3052-89
PRK Marker / Spatula

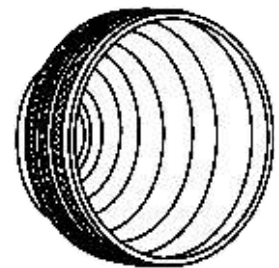

Maloney
SB-3053-91

Intra Operative Keratometer Titanium only
Intra Operative Keratometer Titanium nur
Intra Operative Kératomètre titane seulement
Queratómetro intraoperatoria titanio sólo

Ophthalmology Instruments

Rk/Prk/Lasik Instruments
Rk / PRK / Lasik Instruments

Rk / PRK / Lasik Instruments
Rk / PRK / Instrumentos de Lasik



Mendez
SB-3054-93

Multi Purpose Lasik Forceps
Multi Purpose Lasik Forceps
Multi Purpose Lasik Forceps
Multi Purpose Pinzas Lasik



Lasik
SB-3055-95

Flap Forceps
Flap Forceps
Pincès à rabat
Pinzas Flap

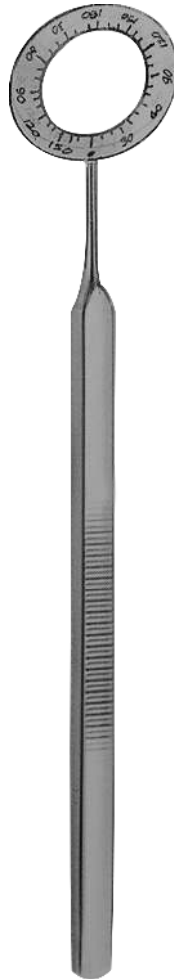

Mendez
SB-3056-97

Degree Gauge
Gradscheibe
Jauge degré
Grado Gauge

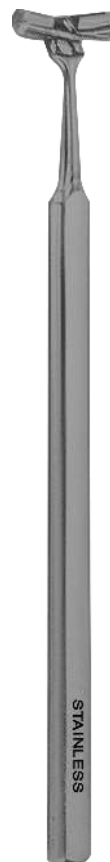

Bores
SB-3057-99

Axis Marker
Achse Marker
marqueur axe
Axis Marker



SB-3058-A 4 lines
SB-3059-02 6 lines
SB-3060-04 8 lines
SB-3061-06 12 lines
SB-3062-08 16 lines

Comeal Marker
Comeal Marker
marqueur cornéen
marcador corneal



Deitz
SB-3063-10
Incision Depth Gauge

Ophthalmology Instruments

Rk / Prk / Lasik Instruments
Rk / PRK / Lasik Instruments

Rk / PRK / Lasik Instruments
Rk / PRK / Instrumentos de Lasik



Hoffer

Optical Zone Marker
Optical Zone Marker
Marqueur Zone Optical
Marcador de Zona Optical

- SB-3064 -12 2.50mm
- SB-3065 -13 2.75mm
- SB-3066 -14 3.00mm
- SB-3067 -15 3.25mm
- SB-3068 -16 3.50mm
- SB-3069 -17 3.75mm
- SB-3070 -18 4.00mm
- SB-3071 -19 4.25mm
- SB-3072 -20 4.50mm
- SB-3073 -21 4.75mm
- SB-3074 -22 5.00mm
- SB-3075 -23 5.50mm
- SB-3076 34 6.00mm
- SB-3077 -25 6.50mm
- SB-3078 -26 7.00mm
- SB-3079 -27 7.50mm
- SB-3080 -28 8.00mm
- SB-3081 -29 8.50mm
- SB-3082 -30 9.00mm
- SB-3083 -31 9.50mm
- SB-3084 -32 10.0mm



Thornton

Optical Zone Marker
Optical Zone Marker
Marqueur Zone Optical
Marcador de Zona Optical

- SB-3085 -33 3.00mm
- SB-3086 -34 3.25mm
- SB-3087 -35 3.50mm
- SB-3088 -36 3.75mm
- SB-3089 -37 4.00mm
- SB-3090 -38 4.25mm
- SB-3091 -39 4.50mm
- SB-3092 -40 4.75mm
- SB-3093 -41 5.00mm
- SB-3094 -42 6.00mm
- SB-3095 -43 6.50mm
- SB-3096 -44 7.00mm
- SB-3097 -45 8.00mm
- SB-3098 -46 9.00mm

Ophthalmology Instruments

Rk/Prk/Lasik Instruments
Rk / PRK / Lasik Instruments

Rk / PRK / Lasik Instruments
Rk / PRK / Instrumentos de Lasik



Bores

Optical Zone Marker
Optical Zone Marker
Marqueur Zone Optical
Marcador de Zona Optical

- SB-3099 -48 2.50mm
- SB-3100 -49 2.75mm
- SB-3101 -50 3.00mm
- SB-3102 -51 3.25mm
- SB-3103 -52 3.50mm
- SB-3104 -53 3.75mm
- SB-3105 -54 4.00mm
- SB-3106 -55 4.25mm
- SB-3107 -56 4.50mm
- SB-3108 -57 4.75mm
- SB-3109 -58 5.00mm
- SB-3110 -59 6.00mm
- SB-3111 -60 7.00mm
- SB-3112 -61 8.00mm



Double Marker
SB-3113-62
3-5mm

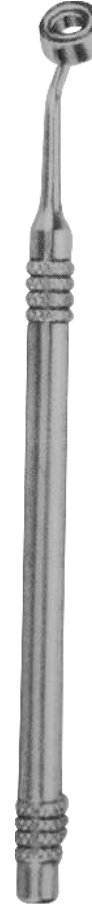

Treple Marker
SB-3114-64
3-5-7mm

Ophthalmology Instruments

Rk/Prk/Lasik Instruments
Rk / PRK / Lasik Instruments

Rk / PRK / Lasik Instruments
Rk / PRK / Instrumentos de Lasik



Grandon

- SB-3115-01 2.5mm wide
- SB-3115-02 2.5mm wide
- SB-3115-03 3.0mm wide
- SB-3115-04 4.0mm wide
- SB-3115-05 5.0mm wide

wide
breite
large
ancho



Kremer

- SB-3116-S
- SB-3116-C

Corneal Fixation Forceps
13mm Spread 12mm Teeth
Corneal Fixierpinzette
13mm verteilen 12mm Zähne
Pince de fixation cornéen
13mm Fais dents 12mm
Pinza corneal fijación
13mm 12mm Corre Dientes

Straight
gerade
droit
recto

Curved
Gebogene
courbé
Curvo



Arrow smith

- SB-3117-S Straight
- SB-3117-C Curved

Corneal Fixation Forceps
8mm Spread 12mm Teeth
Corneal Fixierpinzette
8mm verteilen 12mm Zähne
Pince de fixation cornéen
8mm Fais dents 12mm
Pinza corneal fijación
8mm 12mm Corre Dientes

Straight
gerade
droit
recto

Curved
Gebogene
courbé
Curvo



Bores

- SB-3118-S
- SB-3118-C

Corneal Fixation Forceps
3mm Spread 12mm Teeth
Corneal Fixierpinzette
3mm verteilen 12mm Zähne
Pince de fixation cornéen
3mm Fais dents 12mm
Pinza corneal fijación
3mm 12mm Corre Dientes

Straight
gerade
droit
recto

Curved
Gebogene
courbé
Curvo

Ophthalmology Instruments

Phaco Accessories
Phako-Zubehör

Phaco Accessoires
Faco Accesorios



24-0269-59

- SB-3119-S Straight, straight, straight, straight
- SB-3119-C Curved, Gebogene, courbe, Curvo
- SB-3119-45 45° Angled, Angled, incliné, angular
- SB-3119-90 90° Angled, Angled, incliné, angular
- SB-3119-SI Simcoe,
- SB-3119-B Binklorst

Irrigation/Aspiration Handpiece
0.5mm Dual Sideports
Irrigation / Aspiration Handstück
0.5mm Dual-Seitenöffnungen
Irrigation / Aspiration pièce à main
0.5mm orifices latéraux à double
Irrigación / Aspiración Handpiece
0.5mm Sideports Dual



- SB-3120-15 15°
- SB-3120-30 30°
- SB-3120-45 45°

- SB-3121-01 Tip 30° Curved 5°
- SB-3121-02 Tip 30° Curved 20° Curved Tip



SB-3122-00

Handpiece For
Phaco emulsification
Handstück für
Phaco emulsification
Pièce à main pour
phaco emulsification
pieza de mano para
Faco emulsification



SB-3123-00

Irrigation Silicone Sleeve
Non Sterile-(pcs/pack)
Bewässerung Silikonhülle
Non Sterile-(Stück / Packung)
Silicone Sleeve irrigation
Non Sterile-(pcs / paquet)
Riego Funda de silicona
No Estéril-(unidades / paquete)

Ophthalmology Instruments

Lid Retractors and Retractors

Deckel und Retraktoren Retraktoren

Rétracteurs et rétracteurs

Retradores del párpado y retractoros



Desmarres

SB-3127-00 Infant 7.5mm
SB-3127-01 Child 11mm
SB-3127-02 Small 13mm
SB-3127-03 Medium 15mm
SB-3127-04 Large 17mm

Infant	Child	Small	Medium	Large
Säugling	Kind	klein	Medium	groß
nourrisson	enfant	petit	moyen	grand
infantil	niño	pequeño	medio	grande



Jeffe

Lid Retractor
SB-3124-01
SB-3124-02

Pair, Paar, paire, par

Small Pair, kleine Paar, Paire petit, pequeño par

Large Pair, große Paar, Paire grande, gran par

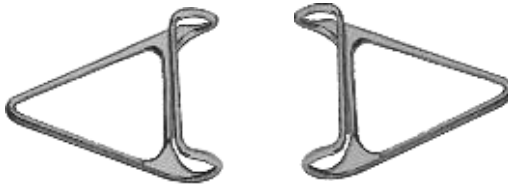

Newell

Lid Retractor Pair
SB-3125-75

Pair
Paar
paire
par



Tennant

Lid Retractor Pair
SB-3126-76

Pair
Paar
paire
par



Rollet

Lacrimal Sac
Retractor

SB-3128-77 Sharp
SB-3128-78 Blunt

Sharp	blunt
scharf	stumpf
net	émousser
agudo	embotar



Axenfeld

Lacrimal Sac
Retractor

3 Prong
SB-3129-79 Sharp
SB-3129-80 Blunt

Sharp	blunt
scharf	stumpf
net	émousser
agudo	embotar



Knapp

Lacrimal Sac
Retractor

4 Prong
SB-3130-01 Sharp
SB-3130-02 Blunt

Ophthalmology Instruments

Iris Retractors
Iris Retraktoren

Rétracteurs Iris
Los retractoros de iris



Rosenbaum-Drews
SB-3131-84 Left and Right
SB-3131-L
SB-3131-R
Left links links Izquierda
Right rechs droit derecho

Rizzuti
Iris Retractor and Lens
Expressor
SB-3132-85



Roger
Iris Retractor
SB-3133-S
SB-3133-L
SB-3133-R



Spivey
Iris Retractor
SB-3134-87



Graether
Cullar Button Iris
Retractor
SB-3135-S Straight
SB-3135-A Angled
SB-3135-B Angled Left
SB-3135-C Angled Right

Straight gerade droit recto
Angled Angled incliné angular

Ophthalmology Instruments

Muculus Splitters
Muculus Splitter

Splitters Muculus
Muculus Splitter



Kansas
Lens Loop Serrated wide
Objektiv Schleife Serrated breit
Objectif boucle crantée large
Lens Loop dentada ancho
SB-3136-89



Kansas
Nucleus Trisector
for manual Small
incision surgery
SB-3137-90



Kansas
Nucleus Bisector
for manual Small
incision surgery
SB-3138-91



Kansas
Nucleus Vectis Solid
used as cutting block
with Kansas insector &
Bbisector for nucleus
fragmentation
SB-3139-92

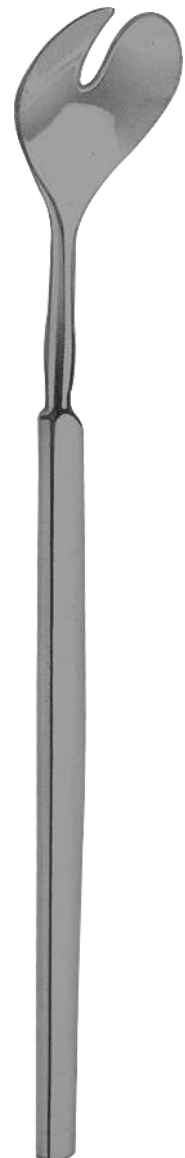

Wells
Enucleation Spoon
SB-3140-93

Ophthalmology Instruments

Spoons & Currettes
Löffel & Küretten

Cuiller et Currettes
Cucharas y Curetas



Pagenstecher
EueSpoon
SB-3141-94

wide
breite
large
ancho



Bunge
Evisceration Spoon
SB-3142-01 8.0mm
SB-3142-02 9.0mm
SB-3142-03 10.0mm
SB-3142-04 11.0mm
SB-3142-05 12.0mm



Hebra
Chalazion Curette, Sharp
SB-3143-01 2.5mm
SB-3143-02 3.5mm
SB-3143-03 4.5mm

Sharp
scharf
net
agudo



Meyhoefer
Chalazion Curette,
Sharp 1mm
SB-3144-A

Sharp
scharf
net
agudo



Meyhoefer
Chalazion Curette, Sharp
SB-3144-00 1.50mm
SB-3144-01 1.75mm
SB-3144-02 2.75mm
SB-3144-03 2.50mm
SB-3144-04 3.50mm

Sharp
scharf
net
agudo

Ophthalmology Instruments

Lacrimal Instruments
lacrimal Instruments

Instruments lacrymales
Instrumentos lagrimal

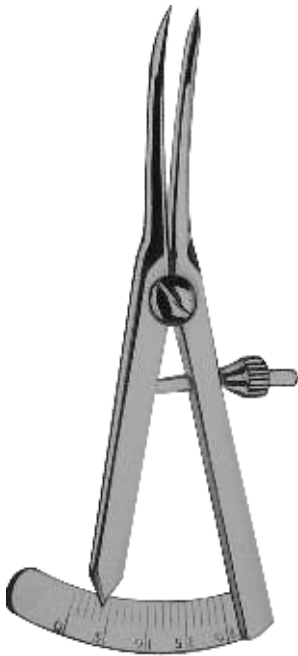

Castroviejo
Caliper 15mm
SB-3145-A
SB-3145-B

Straight
gerade
droit
recto

Curved
Gebogene
courbé
Curvo



Castroviejo
Caliper 20mm
SB-3145-C
SB-3145-D



Left
links
links
Izquierda

Right
rechts
droit
derecho

Harms
Trabeculotomy Probe
SB-3145-E
SB-3145-F

Ziegler
Probe for Lacrimal Canal
SB-3145-G

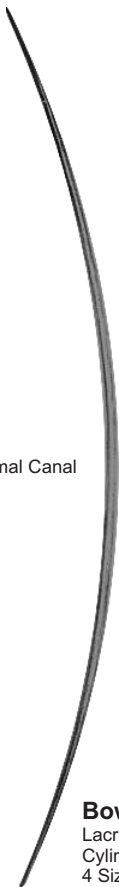

Bowman
Lacrimal Probe
Cylindrical Set of
4 Sizes
SB-3145-H

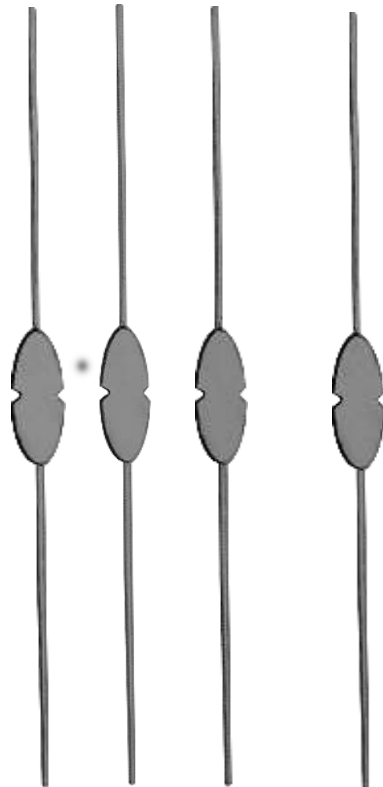

Role
Probe
LacrimalSec
SB-3145-J

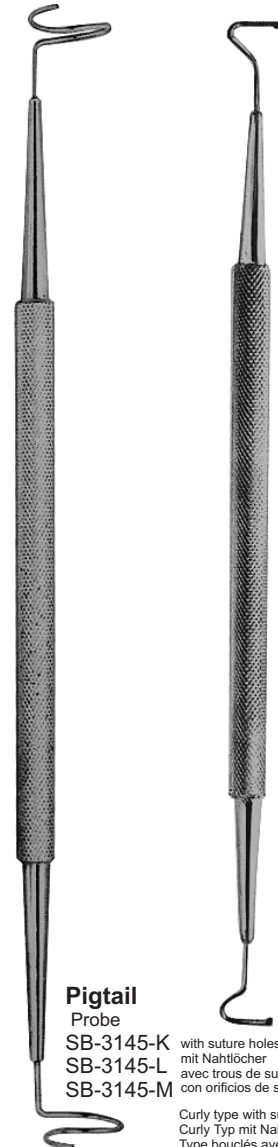

Pigtail
Probe
SB-3145-K
SB-3145-L
SB-3145-M

with suture holes
mit Nahtlöcher
avec trous de suture
con orificios de sutura

Curly type with suture holes
Curly Typ mit Nahtlöcher
Type bouclés avec des trous de suture
Tipo rizado con orificios de sutura

Ophthalmology Instruments

Curettes & Cautery
Küretten & Kautergriff

Curettes et cautérisation
Curetas y Cauterio



Axenfeld
Chalazion Curette,
Sharp Double End
SB-3146-99

Sharp Double End
Sharp Double End
Fin nette Double
Doble fin de Sharp



Nightingale
Capsule Polishing
Curette 1.75mm
SB-3147-00



Gille
Capsule Polishing
Curette 1.75mm
SB-3148-01



Anis
Capsule Scrubber
SB-3149-02



Wills Hospital
Cautery, Delicate
Copper Bail
SB-3150-03



Wills Hospital
Cautery, Delicate
Copper Bail Tip
SB-3151-04

Ophthalmology Instruments

Lacrimal Instruments
lacrimal Instruments

Instruments lacrymales
Instrumentos lagrimal

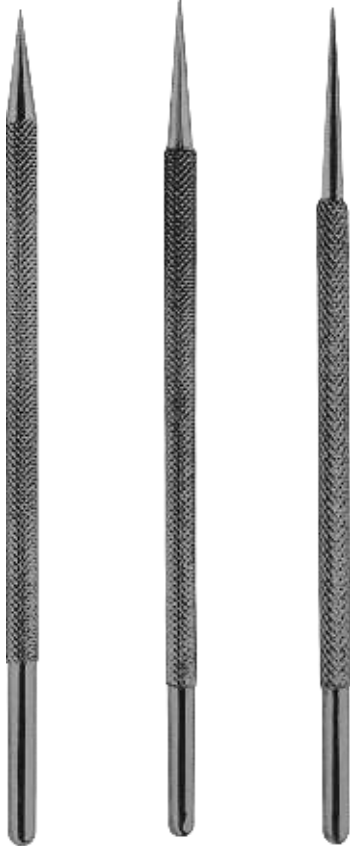

wilder

Lacrimal Dilator
SB-3152-01
SB-3152-02
SB-3152-03

Fine Taper	Medium Taper	Heavy Taper
feine Taper	Medium Taper	schwere Taper
Taper fine	Taper moyen	Taper lourd
Taper Fine	Medium Taper	Taper pesado



Intant lacrimal Dilator
Very Fine Blunt Tip
SB-3153-13

Blunt Tip
Blunt Tip
à bout arrondi
Blunt Tip



Castroviejo

lacrimal Dilator Double End
Fine & Medium Taper
SB-3154-14

Medium Taper
Medium Taper
Taper moyen
Medium Taper



Dastoor

lacrimal Sac Dissector
Double End
SB-3155-15
Double End
Double End
Fin Double
Fin Doble



Lang

lacrimal Sac Dissector
Double End
SB-3156-16
Double End
Double End
Fin Double
Fin Doble

Ophthalmology Instruments

Lacrimal Instruments
lacrimal Instruments

Instruments lacrymales
Instrumentos lagrimal



Graefe
Scarifier for
lacrimal Sec
SB-3157-17



Desmarres
Scarifier for
lacrimal Sec
SB-3158-18



West
Bone Chisel Lacrimal
Sec Straight
SB-3159-19
Straight
gerade
droit
recto



West
Bone Chisel
Lacrimal
Sec Straight
SB-3160-20
Straight
gerade
droit
recto



Freer
Bone Chisel
Lacrimal
Sec Curved
SB-3161-21
Curved
Gebogene
courbé
Curvo



Joseph
Periosteal Elevator
SB-3162-22



Freer
Periosteal Elevator
Double End Sharp &
Blunt
SB-3163-23
Sharp blunt
scharf stumpf
net émousser
agudo embotar

Ophthalmology Instruments

Punches Lacrimal Instruments
Punches Lacrimal Instruments

Poinçons lacrymale Instruments
Punzones lagrimal Instruments



Luntz-Dodick
Trabeculectomy Punch
Rotatable Cutting
SB-3164-A 0.5mm Tip
SB-3164-B 1.0mm Tip
SB-3164-C 1.5mm Tip



Kelley
Decemats Mambrene Punch
SB-3165-25 1.0mm Bite
SB-3165-A 0.75mm Bite
Bite
beißen
mordre
morder

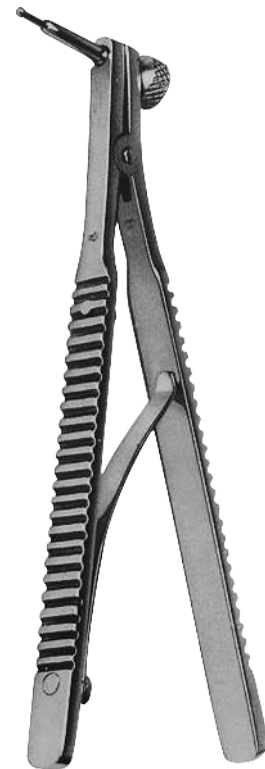

Gass
Comeoscleral Punch
1.0 mm dia
SB-3166-26
Rotatable Tip
drehbaren Spitze
Astuce rotatif
Consejo giratoria

Ophthalmology Instruments

Rongeurs Instruments
Rongeur Instruments

Instruments Rongeurs
roedores Instruments



Beyer
Bone Rongeur
SB-3167-27



Citelli
Bone Rongeur
SB-3168-28

Ophthalmology Instruments

Rongeurs Instruments
Rongeur Instruments

Instruments Rongeurs
roedores Instruments

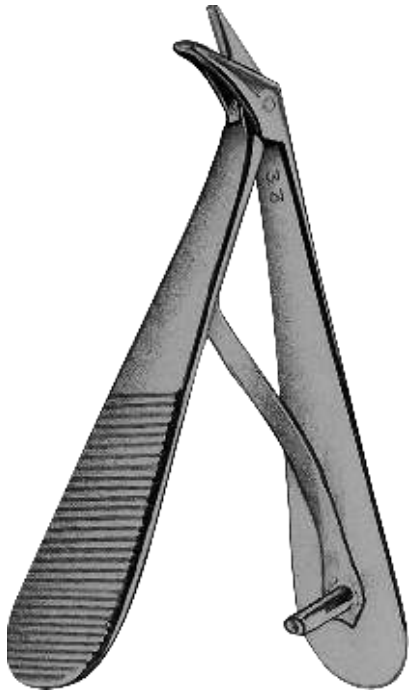

Holth

Comeoscleral Punch
SB-3169-01 1mm
SB-3169-02 1.5mm
SB-3169-03 2mm



Adler

Bone Rongeur
SB-3170-30



Kerrison

Bone Rongeur
SB-3171-01 Small Medium Large
SB-3171-02 klein Medium groß
SB-3171-03 petit moyen grand
pequeño medio grande

Ophthalmology Instruments

Forceps forceps
Zange fórceps



Hartmann
Mosquito Forceps 3.25"
SB-3172-S Straight
SB-3172-C Curved
Straight Curved
gerade Gebogene
droit courbé
recto Curvo



Hasted
Mosquito Forceps 5.50"
SB-3173-S Straight
SB-3173-C Curved
Straight Curved
gerade Gebogene
droit courbé
recto Curvo



Serrefine
1.5"
SB-3174-S Straight
SB-3174-C Curved
Straight Curved
gerade Gebogene
droit courbé
recto Curvo



Backhaus
Towel Clamp
SB-3175-01 3.50"
SB-3175-02 5.25"



Towel Clamp
Handtuch Clamp
Pince serviette
Toalla Clamp

Jones
Towel Clamps
SB-3176-36

Ophthalmology Instruments

Forceps
Zange

forceps
forceps

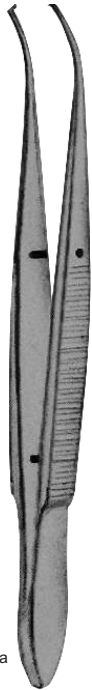

Half Curved
halbgebogen
La moitié courbé
La mitad de curva

Iris Forceps
1 x 2 Teeth,
Half Curved
SB-3177-37



Full Curved
Vollständige Curved
pleine courbe
completo Curved

Iris Forceps
1 x 2 Teeth, Straight
SB-3178-38
Straight
gerade
droit
recto

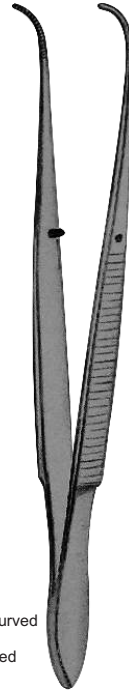

Eye Dressing Forceps
Serrated, Full Curved
SB-3179-39

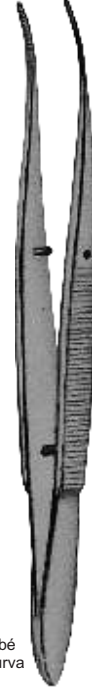

Half Curved
halbgebogen
La moitié courbé
La mitad de curva

Eye Dressing Forceps
Serrated, Half Curved
SB-3180-40



Straight
gerade
droit
recto

Eye Dressing Forceps
Serrated, Straight
SB-3180-41



Full Curved
Vollständige Curved
pleine courbe
completo Curved

Iris Forceps
1 x 2 Teeth, Full Curved
SB-3181-42



Bishop-Harmon
Iris Forceps 1x2 Teeth,
Extra Delicate
SB-3182-A 0.3mm
SB-3182-B 0.5mm
SB-3182-43 Serrated



Hees
Iris Forceps Swiss
Model 1x2
SB-3183-44



Straight
gerade
droit
recto

Utility
Forceps 4" Serrated
Straight
SB-3184-45



Straight
gerade
droit
recto

Utility
Forceps 4"
1x2 Straight
SB-3185-46

Ophthalmology Instruments

Forceps forceps
Zange fórceps



McCullaugh
Utility Forceps Serrated
SB-3186-47



McCullaugh
Utility Forceps 1x2
Serrated
SB-3187-48



Wills Hospital
Utility Forceps Serrated
SB-3188-49



Bonaccolto
Utility Forceps Serrated
SB-3189-50



Bonaccolto
Utility Forceps
Heavy Model
SB-3190-50



without Catch
ohne Fang
sans Catch
sin capturas

Graefe
Fixation Forceps
SB-3191-51 without Catch



without Catch
ohne Fang
sans Catch
sin capturas

Waldau
Fixation Forceps
SB-3192-52 without Catch



Schmidt-Rimpler
Fixation Forceps
SB-3193-53

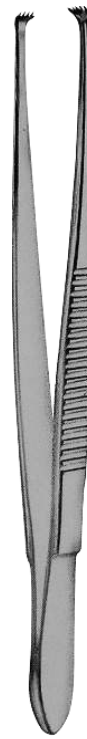

Jeas
Fixation Forceps
SB-3194-54



Barraquer
Fixation Forceps
SB-3195-55

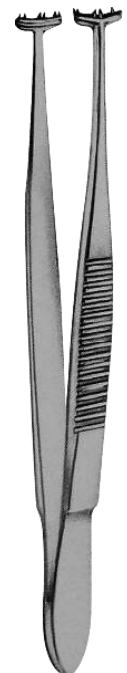

Troutman-Llobera
Fixation Forceps
SB-3196-56

Ophthalmology Instruments

Forceps
Zange

forceps
forceps

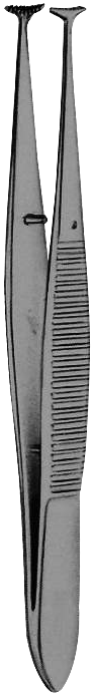

Green
Fixation Forceps
SB-3197-01 5mm
SB-3197-02 10mm

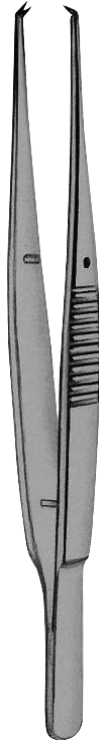

Elschnig
Fixation Forceps
SB-3198-58

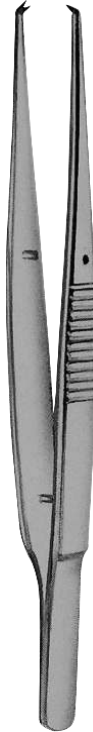

Kuhnt
Fixation Forceps
SB-3199-59

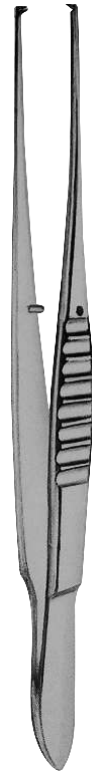

Fixation Forceps 4.50:
1 x 2 Teeth
SB-3200-60
1 x 2 Teeth
1 x 2 Zähne
1 x 2 dents
1 x 2 dientes



1 x 2 Teeth
1 x 2 Zähne
1 x 2 dents
1 x 2 dientes

Fixation Forceps 4.50"
1 x 2 Teeth
SB-3201-61



2 x 3 Teeth
2 x 3 Zähne
2 x 3 dents
2 x 3 dientes

Fixation Forceps 4.25"
2 x 3 Teeth
SB-3202-62



1 x 2 Teeth 3 x 3 Teeth
1 x 2 Zähne 3 x 3 Zähne
1 x 2 dents 3 x 3 dents
1 x 2 dientes 3 x 3 dientes

Lester
Fixation Forceps
SB-3203-01 1 x 2 Teeth
SB-3203-02 3 x 3 Teeth

Ophthalmology Instruments

Forceps forceps
Zange fórceps



Harms
Colibri Forceps
0.12mm
SB-3204-64



Castroviejo
Colibri Forceps
0.12mm
SB-3205-65



Polack
Double Corneal Forceps
10mm spread 0.12mm
SB-3206-66



Cohan
Colibri Forceps
0.3mm Teeth
SB-3207-67



Pierse
Corneal Colibri Forceps
1 x 1 Pierse Teeth,
Delicate Straight
SB-3209-01 0.1mm
SB-3209-02 0.3mm



Moorfield
Suture Forceps
SB-3210-70



Pierse
Corneal Colibri Forceps
1 x 1 Pierse Teeth, Delicate
SB-3208-01 0.1mm
SB-3208-02 0.3mm



with Teeth & Platform
mit Zähnen & Plattform
avec les dents et la plate-forme
con dientes y plataforma

Girard
Corneal Scleral Forceps
with Teeth & Platform
SB-3211-71

Ophthalmology Instruments

Forceps
Zange

forceps
fórceps

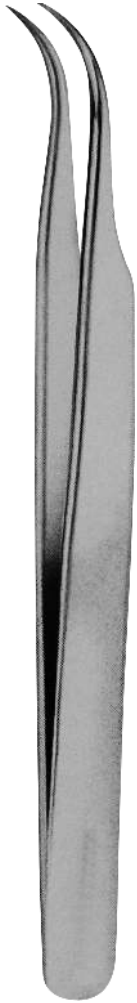

Jewelers
Forceps
SB-3212-71



Jewelers
Forceps
SB-3213-71

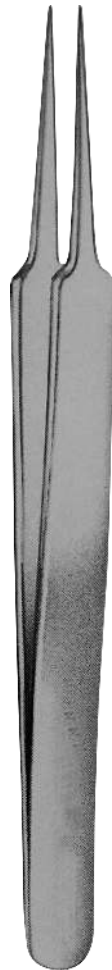

Jewelers
Forceps
SB-3214-71

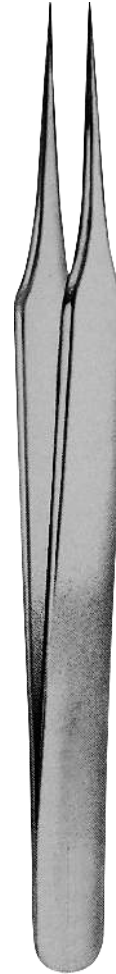

Jewelers
Forceps
SB-3215-71

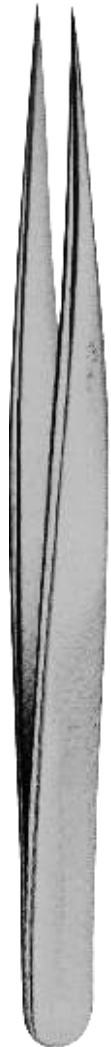

Jewelers
Forceps
SB-3216-71

Ophthalmology Instruments

Forceps forceps
Zange fórceps



Lims
Forceps 1 x 2
Teeth very Delicate
SB-3217-72



Mcperson
Corneal Forceps
1 x 2 Teeth
SB-3218-S Straight
SB-3218-A Angled

Straight Angled
gerade Angled
droit incliné
recto angular

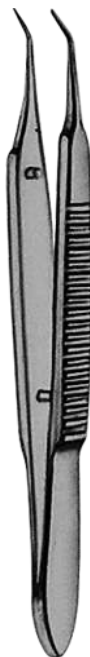

Mcperson
Tying Forceps,
SB-3219-S Straight
SB-3219-A Angled

Straight Angled
gerade Angled
droit incliné
recto angular



Kelman-Mcperson
Forceps 8mm Angled
SB-3220-75 1 x 2 Teeth
SB-3220-75 Smooth



Bechert-Mcperson
Forceps, 11mm Angled
SB-3221-76
Angled
Angled
incliné
angular



Tying
Forceps without
Teeth
SB-3222-77



Harms-Jaffe
Tying Forceps
SB-3223-S
SB-3223-C



Sinskey
Tying Forceps
SB-3224-S
SB-3224-C



Tennant
Tying Forceps
SB-3225-S
SB-3225-C



O'Gawa
Tying Forceps
SB-3226-S
SB-3226-C

Ophthalmology Instruments

Forceps
Zange

forceps
förceps



Blaydes
IOL, Insertion
Forceps
SB-3227-82



Clayman
Lens Holding Forceps
SB-3228-83



with lock
mit Schloss
avec serrure
con cerradura

without lock
ohne Schloss
sans serrure
sin cerradura

Shepard
IOL, Forceps, Oval Tip
SB-3229-84 without Lock
SB-3229-84A with Lock



Bechert
Lens Holding Forceps
SB-3230-85



Faulkner
Lens Holding Forceps
SB-3231-86



Faulkner
Lens Holding Forceps
SB-3232-87



Bonaccolta
Capsules Fragment
Forceps
SB-3233-88



Feaster
Lens Holding Forceps
SB-3234-89

Ophthalmology Instruments

Forceps forceps
Zange fórceps



Kraff
Capsule Tag
Forceps 11mm
SB-3235-90



Barraquer
Cilia Forceps
SB-3236-91



Beer
Cilia Forceps
SB-3237-92



Ziegler
Cilia Forceps
SB-3238-93



Utrata
Capsulorhexis Forceps
Cystotome Tips, 11mm Long thin
SB-3239-94

Cystotome Tips,
11mm Long thin
Cystotome Tipps,
11mm Lange dünne
Conseils cystotome,
11mm long et mince
Consejos cistitomo
11mm, largo y delgado



Utrata
Capsulorhexis Forceps
Cystotome Tips, 11mm Long thin
SB-3240-95

Cystotome Tips,
11mm Long thin
Cystotome Tipps,
11mm Lange dünne
Conseils cystotome,
11mm long et mince
Consejos cistitomo
11mm, largo y delgado



Masket
Capsulorhexis Forceps
Cystotome Tips, 11mm Long Curved
SB-3241-96

Cystotome Tips,
11mm Long Curved
Cystotome Tipps,
11mm Lange Gebogene
Conseils cystotome,
11mm long courbe
Consejos cistitomo
11mm, largo Curvo

Ophthalmology Instruments

Forceps
Zange

forceps
forceps



Cystotome Tips,
11mm Long Curved
Cystotome Tipps,
11mm Lange Gebogene
Conseils cystotome,
11mm long courbe
Consejos cistitomo
11mm, largo Curvo

Utrata

Capsulorhexis Forceps
Cystotome Tips,
11mm Long Curved
SB-3242-97



Cystotome Tips,
11mm Long Curved
Cystotome Tipps,
11mm Lange Gebogene
Conseils cystotome,
11mm long courbe
Consejos cistitomo
11mm, largo Curvo

Utrata

Capsulorhexis Forceps
Cystotome Tips,
11mm Long Curved
SB-3243-98



Livernois
IOL Holding & Folding
Forceps
SB-3244-99



Livernois
IOL Holding Forceps
SB-3245-00



with lock
mit Schloss
avec serrure
con cerradura
without lock
ohne Schloss
sans serrure
sin cerradura
IOL Inserting Forceps
SB-3246-01 without lock
SB-3246-01 with lock



Soft IOL Inserting Forceps
SB-3247-02



Steinert
Universal Folding
Forceps
SB-3248-03



Fine
Inserting Forceps
SB-3249-04



Koch
Universal Lens
Folder for Silicone
Lenses
SB-3250-05

Ophthalmology Instruments

Forceps forceps
Zange fórceps



Ernest
Nucleus Cracker
SB-3251-06



Sharp Tips
Sharp Tipps
Conseils pointus
Punta aguda

Pre-Chopper
Sharp Tips
Maximum Oppening
2.8mm
SB-3252-07



Pre-ChopperFor
Soft Cataracts
Wider Jaw Help
Split Soft Nucleus
SB-3253-08



Berke
Ptosis Clamp. 20mm
SB-3254-09

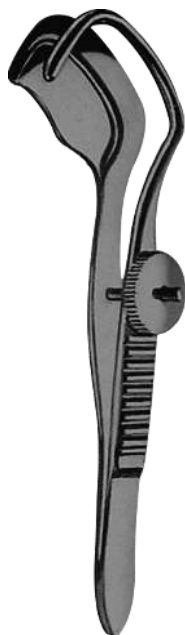

Snellen
Entropion Forceps
SB-3255-10



Ayer
Chalazion Forceps
SB-3256-11 without Stop Screw
SB-3256-11 with Stop Screw

without Stop Screw
ohne Anschlagsschraube
sans vis de butée
sin tornillo de parada

with Stop Screw
mit Anschlagsschraube
avec vis d'arrêt
con tornillo de parada



Lambert
Chalazion Forceps
SB-3257-12



Hunt
Chalazion Forceps
SB-3258-13

Ophthalmology Instruments

Forceps & Bipolar Forceps
Pinzetten & Bipolarzangen

Pince & pince bipolaire
Pinzas y pinzas bipolares



Desmarres
Chalazion Forceps Oval
SB-3259-00 15mm
SB-3259-01 20mm
SB-3259-02 26mm
SB-3259-03 31mm



Erhardt
Lid Forceps
SB-3260-15

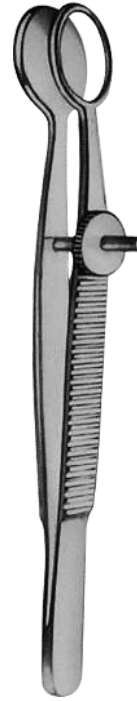

Heath
Chalazion Forceps
SB-3261-16



Lordan
Chalazion Forceps
SB-3262-17



Coaptation
Bipolar Forceps
SB-3263-18



McPherson
Bipolar Forceps
SB-3264-19 Straight
SB-3264-19A Angled

Straight
gerade
droit
recto
Angled
Angled
incliné
angular



Colibri
Bipolar Forceps
SB-3265-20



Jewelers
Bipolar Forceps
SB-3266-21

Ophthalmology Instruments

Hoskine Forceps
Hoskine Zange

Hoskine Forceps
Hoskine Pinzas



Pieris-Hoskin
Fixation Forceps
SB-3267-22



Pieris-Hoskin
Fine Forceps,
Straight
SB-3268-23
Straight
gerade
droit
recto



Pieris-Hoskin
Large Forceps
Angled
SB-3269-24
Angled
Angled
incliné
angular



Pieris-Hoskin
Micro Forceps,
Straight
SB-3270-25
Curved
Gebogene
courbé
Curvo



Pieris-Hoskin
Micro Forceps,
Curved
SB-3271-26
Curved
Gebogene
courbé
Curvo



Pieris-Hoskin
Suture Forceps
SB-3272-27



Pieris-Hoskin
Sekelton Fine
Forceps
SB-3273-28



Pieris-Hoskin
Sekelton Micro
Forceps
SB-3274-29



Pieris-Hoskin
Sekelton Fixation
Forceps
SB-3275-30



Pieris-Hoskin
Fine Beaked Coliton
Forceps
SB-3276-31



Pieris-Hoskin
Fine Beaked Micro
Coliton Forceps
SB-3277-32

Ophthalmology Instruments

Scissors ciseaux
Schere tijeras

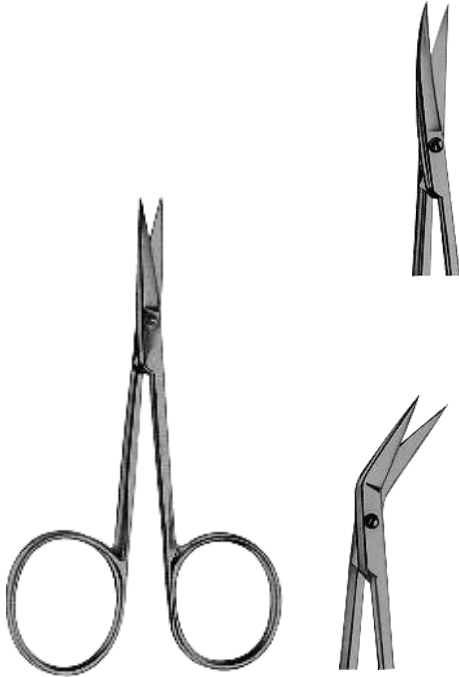

Iris Scissors 3 1/2"

SB-3278-33	Straight	
SB-3279-34	Curved	
SB-3280-35	Angled	
Straight	Curved	Angled
gerade	Gebogene	Angled
droit	courbé	incliné
recto	Curvo	angular



Iris Scissors 4 1/8"

SB-3281-36	Straight
SB-3282-37	Curved
Straight	Curved
gerade	Gebogene
droit	courbé
recto	Curvo



Iris Scissors 4 1/2"

SB-3283-38	Straight
SB-3284-39	Curved
Straight	Curved
gerade	Gebogene
droit	courbé
recto	Curvo



**Knapp
Iris Scissors 4 1/2"**

SB-3285-S	Straight
SB-3285-C	Curved
SB-3286-S	Straight
SB-3286-C	Curved
Straight	Curved
gerade	Gebogene
droit	courbé
recto	Curvo



Eye Scissors 5" Pointed

SB-3287-S	Straight
SB-3287-C	Curved
Straight	Curved
gerade	Gebogene
droit	courbé
recto	Curvo

Ophthalmology Instruments

Scissors ciseaux
Schere tijeras



Straight Blunt	Curved Blunt
Straight Pointed	Curved Pointed
Gerade Spitz	Gebogene Pointed
Droit pointu	courbé pointu
Straight punta	Curva punta

Stevens
Tenotomy Scissors,
New Model
SB-3288-S Straight Blunt
SB-3289-S Straight Pointed
SB-3290-C Curved Blunt
SB-3291-C Curved Pointed

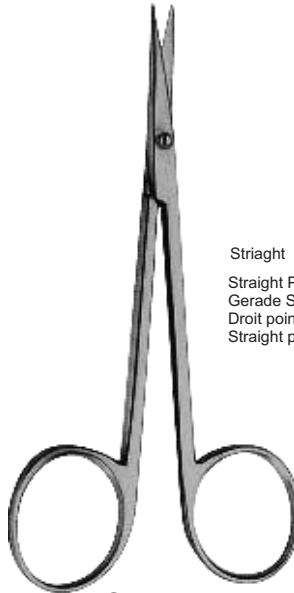

Straight Blunt	Curved Blunt
Straight Pointed	Curved Pointed
Gerade Spitz	Gebogene Pointed
Droit pointu	courbé pointu
Straight punta	Curva punta

Stevens
Tenotomy Scissors,
Long Model
SB-3292-S Straight Blunt
SB-3293-S Straight Pointed
SB-3294-C Curved Blunt
SB-3295-C Curved Pointed



Spencer
Stitch Scissors, 3.5"
SB-3296-52

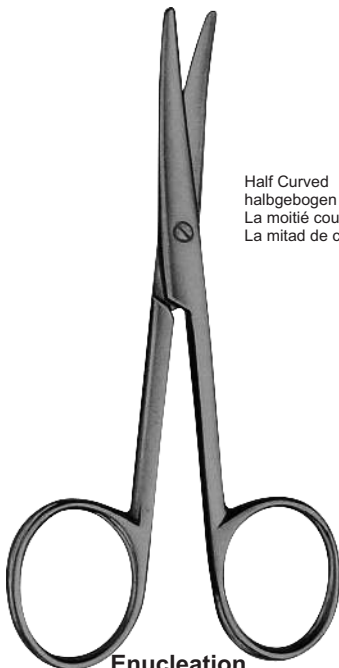

Half Curved	Full Cruved
halbgebogen	Vollständige Cruved
La moitié courbé	plein Cruved
La mitad de curva	completo Cruved

Enucleation
Scissors
SB-3297-53 Half Curved
SB-3298-54 Full Cruved



Half Curved	Full Cruved
halbgebogen	Vollständige Cruved
La moitié courbé	plein Cruved
La mitad de curva	completo Cruved

Bonn Model
Iris Scissors Delicate
SB-3299-55 Half Curved
SB-3300-56 Full Cruved

Ophthalmology Instruments

Scissors ciseaux
Schere tijeras

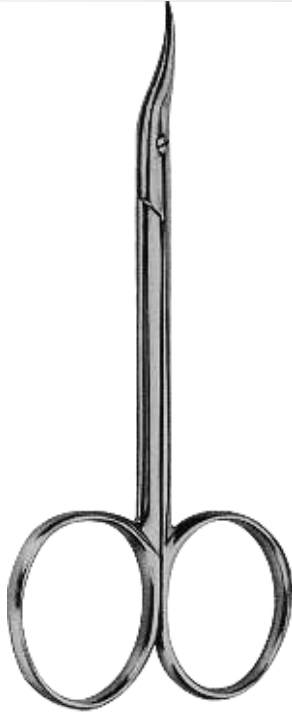

Mc Guire
Comeal Scissors
SB-3301-57 Left
SB-3302-58 Right
Left links Right rechte links
links droit
Izquierda derecho



De-Wecker
Iris Scissors
SB-3303-A Sharp Tips
SB-3304-B Sharp & Blunt Tips
SB-3305-C Blunt Tips

Sharp Tips
Sharp Tipps
Conseils pointus
Punta aguda

Blunt Tips
Blunt Tipps
Conseils Blunt
Consejos Blunt



Noyes
Iris Scissors
SB-3306-A Sharp Tips
SB-3307-B Sharp & Blunt Tips
SB-3308-C Blunt Tips

Sharp Tips
Sharp Tipps
Conseils pointus
Punta aguda

Blunt Tips
Blunt Tipps
Conseils Blunt
Consejos Blunt



Barraquer
Iris Scissors
SB-3309-A 7mm Blade
SB-3310-B 10mm Blade



Vannas
Capsulotomy Scissors
very delicate 6mm Blade
SB-3311-S Straight
SB-3312-C Curved
SB-3313-A Angled

Straight gerade droit recto
Curved Gebogene courbé Curvo
Angled Anglé incliné angular



Gills-Welsh Vannas
Capsulotomy Scissors
very delicate 11mm Blade
SB-3314-70



Gills Vannas
Capsulotomy Scissors
very delicate 11mm Blade
SB-3315-S Straight
SB-3316-C Curved

Straight gerade droit recto
Curved Gebogene courbé Curvo



Stern-Gills
Scissors 10mm
SB-3317-73



Ubire-Stern
Scissors 10mm
SB-3318-74

Ophthalmology Instruments

Scissors ciseaux
Schere tijeras



Blunt Tips
Blunt Tipps
Conseils Blunt
Consejos Blunt

Pointed Tips
Feine Spitzen
Conseils pointus
puntas

Westcott
Tenotomy Scissors
Standard Blades
SB-3319-75
SB-3320-76



Blunt Tips
Blunt Tipps
Conseils Blunt
Consejos Blunt

Pointed Tips
Feine Spitzen
Conseils pointus
puntas

Westcott
Tenotomy Scissors
Medium Blades
SB-3321-77
SB-3322-78



Blunt Tips
Blunt Tipps
Conseils Blunt
Consejos Blunt

Pointed Tips
Feine Spitzen
Conseils pointus
puntas

Mcperson-westcott
Stitch Scissors,
Small Blades
SB-3323-79
SB-3324-80



Jeffe
Stitch Scissors,
Medium Blades Sharp Tips
SB-3325-79
SB-3326-80



Castroviejo
Corneal Scissors,
Strong Curve, Blunt Tips
SB-3327-81



Castroviejo
Corneal Scissors,
Slightly Curve, Blunt Tips
SB-3328-82



Castroviejo
Miniature Corneal
Scissors,
SB-3329-83



Castroviejo
Miniature Corneal
Scissors,
SB-3330-84 Curved

Curved
Gebogene
courbé
Curvo



Castroviejo
Miniature Corneal
Scissors, Blunt Tips
SB-3331-85 Curved

Curved
Gebogene
courbé
Curvo

Ophthalmology Instruments

Scissors ciseaux
Schere tijeras



Castroviejo
Miniature Comeal
Scissors, Blunt Tips
SB-3332-86 Angled
incliné
angular



Katzin
Miniature Comeal
Scissors,
SB-3333-87 Right
SB-3334-88 Left
Left links Right rechte
links droit
Izquierda derecho



Katzin
Miniature Comeal
Scissors, Medium
Blade
SB-3335-89 Right
SB-3336-90 Left
Left links Right rechte
links droit
Izquierda derecho



Castroviejo
Comeal Scissors,
Blunt Tips
SB-3337-91 Angled
incliné
angular



Castroviejo
Comeal Scissors,
SB-3338-90 Right
SB-3339-93 Left
Left links Right rechte
links droit
Izquierda derecho



Left links Right rechte
links droit
Izquierda derecho

Castroviejo
Miniature Comeal Scissors,
SB-3340-94 Right
SB-3341-95 Left



Left links Right rechte
links droit
Izquierda derecho

Troutman Castroviejo
Micro Comeal Scissors,
SB-3342-96 Right
SB-3343-97 Left



Left links Right rechte
links droit
Izquierda derecho

Troutman Castroviejo
Micro Comeal Scissors,
with stop lock
SB-3344-98 Right
SB-3345-99 Left



Left links Right rechte
links droit
Izquierda derecho

Troutman Castroviejo
Comeosleral Scissors,
with stop lock
Medium Blades
SB-3346-00 Right
SB-3347-01 Left

Ophthalmology Instruments

Needle Holders
Nadelhalter

Porte-aiguilles
Porta Agujas



Arruga
Needle Holder
SB-3348-02 Straight
SB-3349-03 Curved

Straight Curved
gerade Gebogene
droit courbé
recto Curvo



Kalt
Needle Holder
SB-3350-04 Straight
SB-3351-05 Curved

Straight Curved
gerade Gebogene
droit courbé
recto Curvo



Castroviejo-Kalt
Needle Holder
with Scissors
SB-3352-06



Barraquer
Needle Holder Curved
without Lock 5.5"
SB-3353-07



Baby Barraquer
Needle Holder, Delicate
SB-3354-A Straight with Lock
SB-3355-B Straight without Lock
SB-3356-A Curved with Lock
SB-3357-B Curved without Lock

Straight with Lock
Gerade mit Schloss
Droit avec verrouillage
Recto con bloqueo

Straight without Lock
Gerade ohne Sperre
Droite sans serrure
Recto sin bloqueo

Curved with Lock
Gebogen mit Sperre
Courbé avec verrouillage
Curvo con cerradura

Curved without Lock
Gebogene ohne Lock
Courbé sans verrouillage
Curva sin bloqueo



Castroviejo
Needle Holder, Delicate
SB-3358-A Straight with Lock
SB-3359-B Straight without Lock
SB-3360-A Curved with Lock
SB-3361-B Curved without Lock

Straight with Lock
Gerade mit Schloss
Droit avec verrouillage
Recto con bloqueo

Straight without Lock
Gerade ohne Sperre
Droite sans serrure
Recto sin bloqueo

Curved with Lock
Gebogen mit Sperre
Courbé avec verrouillage
Curvo con cerradura

Curved without Lock
Gebogene ohne Lock
Courbé sans verrouillage
Curva sin bloqueo



Castroviejo
Needle Holder, Standard
SB-3362-A Straight with Lock
SB-3363-B Straight without Lock
SB-3364-A Curved with Lock
SB-3365-B Curved without Lock

Straight with Lock
Gerade mit Schloss
Droit avec verrouillage
Recto con bloqueo

Straight without Lock
Gerade ohne Sperre
Droite sans serrure
Recto sin bloqueo

Curved with Lock
Gebogen mit Sperre
Courbé avec verrouillage
Curvo con cerradura

Curved without Lock
Gebogene ohne Lock
Courbé sans verrouillage
Curva sin bloqueo

Ophthalmology Instruments

Needle Holders & Breakers
Nadelhalter & Breakers

Porte-aiguilles et disjoncteurs
Cajas de los interruptores automáticos



Stevens
Needle Holder, Straight
SB-3366-A with Lock
SB-3367-B without Lock
with lock without lock
mit Schloss ohne Schloss
avec serrure sans serrure
con cerradura sin cerradura



Mcpherson
Needle Holder
SB-3368-A Straight with Lock
SB-3368-B Straight without Lock
SB-3369-A Curved with Lock
SB-3369-B Curved without Lock

Straight with Lock
Gerade mit Schloss
Droit avec verrouillage
Recto con bloqueo

Straight without Lock
Gerade ohne Sperre
Droite sans serrure
Recto sin bloqueo

Curved with Lock
Gebogen mit Sperre
Courbé avec verrouillage
Curvo con cerradura

Curved without Lock
Gebogene ohne Lock
Courbé sans verrouillage
Curva sin bloqueo



Needle Holder
Very Delicate Jaws
SB-3370-A Straight with Lock
SB-3371-B Straight without Lock
SB-3372-A Curved with Lock
SB-3373-B Curved without Lock

Straight with Lock
Gerade mit Schloss
Droit avec verrouillage
Recto con bloqueo

Straight without Lock
Gerade ohne Sperre
Droite sans serrure
Recto sin bloqueo

Curved with Lock
Gebogen mit Sperre
Courbé avec verrouillage
Curvo con cerradura

Curved without Lock
Gebogene ohne Lock
Courbé sans verrouillage
Curva sin bloqueo



Castroviejo
Blade Breaker & Holder
SB-3374-19



Castroviejo
Blade Breaker & Holder
Slim Model
SB-3375-20 Slim
SB-3376-21 12cm



Carbon Steel
Double Edged Blade
for Blade Breaker & holder
Box-100 Sterile
SB-3377-22

Ophthalmology Instruments

Handle, Collects, Blades
Handle, sammelt, Blades

Poignée, Collecte, Blades
Mango, recoge, cuchillas



For Use with all
Blades Won Sterile
Zur Verwendung mit
allen Blades Won Sterile
Destiné à être utilisé avec
tous les Lames Stériles Won
Para uso con todos los
Hojas Won estéril

Chuck Handle
For Use with all
Blades Won Sterile
SB-3378-02 2"
SB-3378-03 3"
SB-3378-04 4"
SB-3378-06 6"
SB-3378-4H 4"



Bard-Parker
Handle
SB-3379-03 3"
SB-3379-04 4"
SB-3379-07 7"

Bard-Pariizer
Handle
SB-3380-10 # 10
SB-3380-11 # 11
SB-3380-15 # 15



Serving Health Care

SPEED BIRD

ENTERPRISES



**161/C, SMALL INDUSTRIAL ESTATE
SIALKOT-51310, (PAKISTAN)**



: +92-304 0549944



: +92-52-3555584



: speed@birddent.com



: www.birddent.com