



*Serving Health Care*

**SPEED BIRD**  
ENTERPRISES

[www.birddent.com](http://www.birddent.com)

**GYNECOLOGY INSTRUMENTS**

**SECTION**

**20**

## Gynecology Instruments

Vaginal Speculas  
Vaginal Speculas

Speculas vaginales  
especulos vaginales

Scheme of Dimensions for Specula

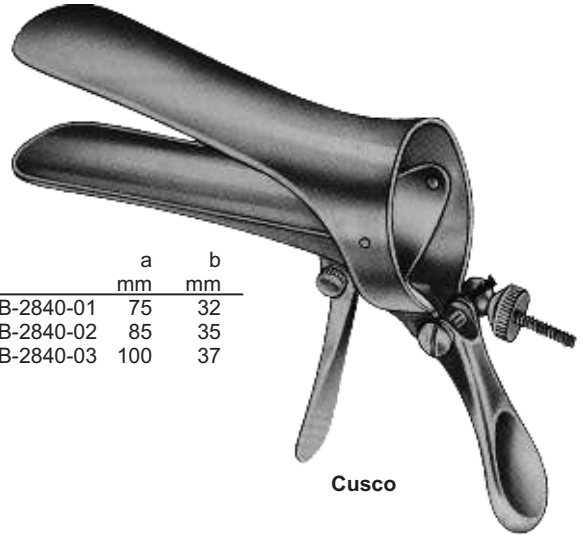
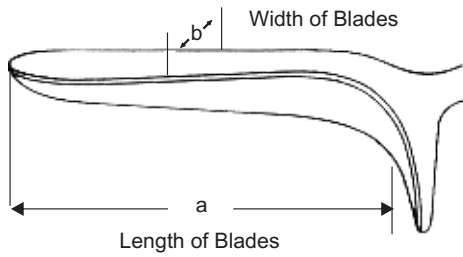

	a mm	b mm
SB-2840-01	75	32
SB-2840-02	85	35
SB-2840-03	100	37

Cusco

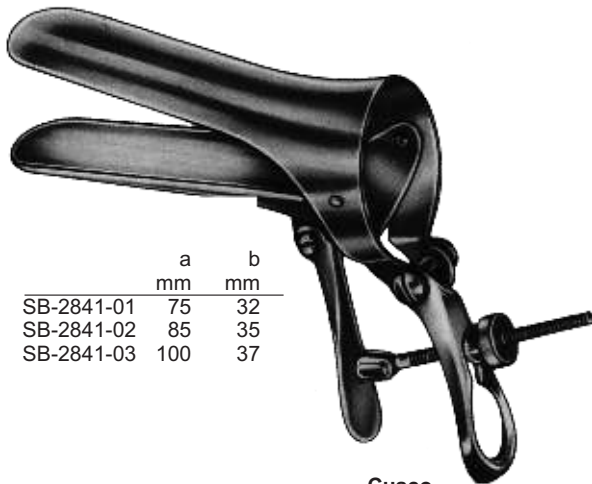

	a mm	b mm
SB-2841-01	75	32
SB-2841-02	85	35
SB-2841-03	100	37

Cusco



For Virgins	a mm	b mm
SB-2842-00	75	17

Cusco



For Virgins	a mm	b mm
SB-2843-00	75	17

Cusco

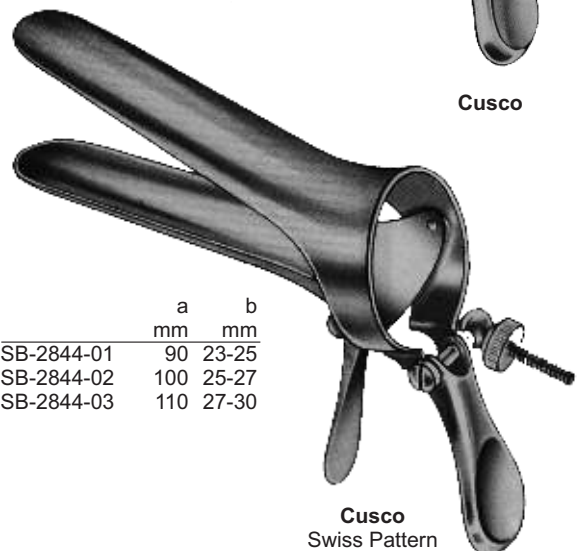

	a mm	b mm
SB-2844-01	90	23-25
SB-2844-02	100	25-27
SB-2844-03	110	27-30

Cusco  
Swiss Pattern

## Gynecology Instruments

Vaginal Speculas  
Vaginal Speculas

Speculas vaginales  
especulos vaginales

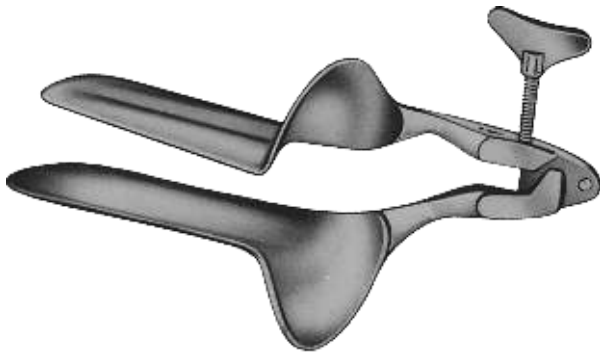

**Collin-Landau**

	a	b
	mm	mm
SB-2845-01	85	30
SB-2845-02	100	35
SB-2845-03	110	40

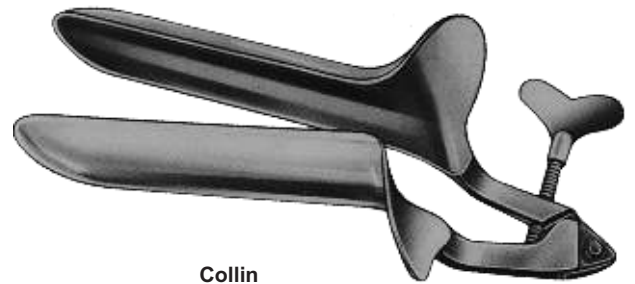

**Collin**

	a	b
	mm	mm
SB-2846-01	85	30
SB-2846-02	100	35
SB-2846-03	110	40

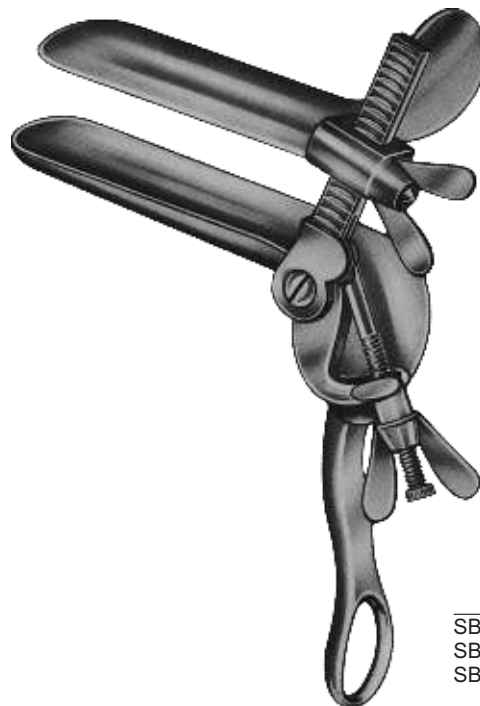

**Trelat**

	a	b
	mm	mm
SB-2847-01	85	33
SB-2847-02	95	35
SB-2847-03	115	43

## Gynecology Instruments

Vaginal Speculas For Laser Surgery  
Vaginal Speculas Für Laser-Chirurgie

Speculas vaginaux pour la chirurgie laser  
Especulos vaginales para la cirugía láser



**Grave (Standard)**

	a mm	b mm
SB-2848-01	75	20
SB-2848-02	95	30
SB-2848-03	115	35
SB-2848-04	125	35

**Black**



<b>Grave</b>	a mm	b mm
SB-2849-01	75	20
SB-2849-02	95	30
SB-2849-03	115	35

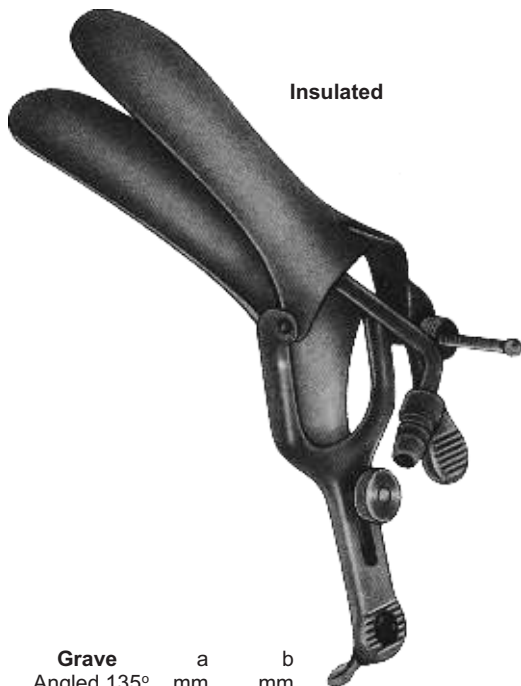

**Insulated**

<b>Grave</b>	a mm	b mm
Angled 135°	101	35
SB-2850-00	101	35

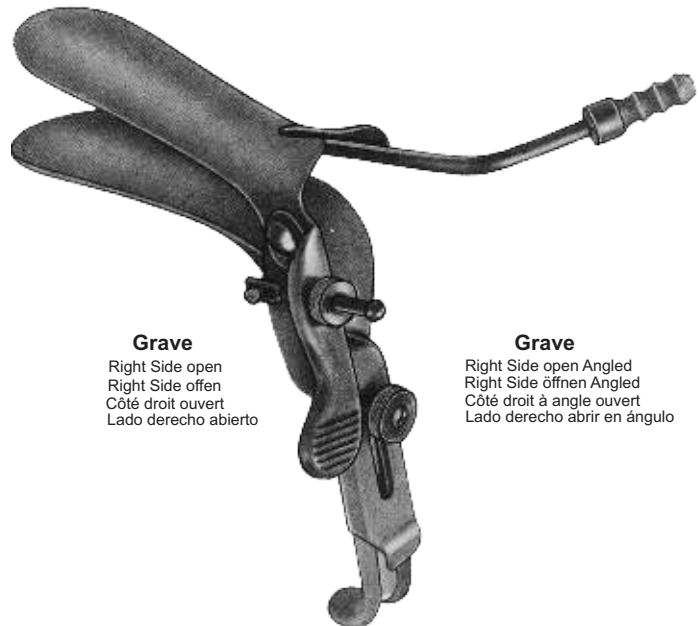

**Grave**

Right Side open  
Right Side offen  
Côté droit ouvert  
Lado derecho abierto

**Grave**

Right Side open Angled  
Right Side öffnen Angled  
Côté droit à angle ouvert  
Lado derecho abrir en ángulo

	a mm	b mm
SB-2851-01	101	35
SB-2851-02	101	35

## Gynecology Instruments

Vaginal Speculas  
Vaginal Speculas

Speculas vaginales  
espéculos vaginales

Lateral Specula

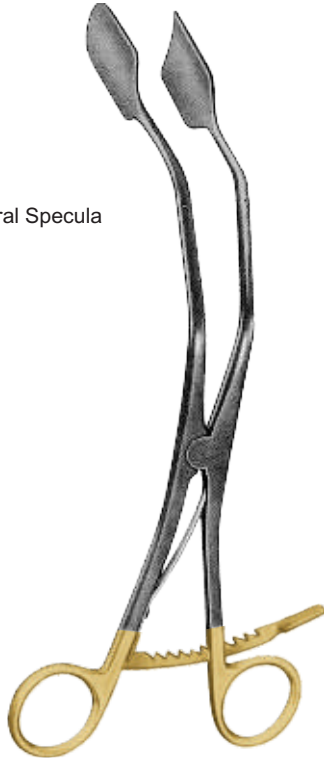

SB-2852-00



Pederson	a mm	b mm
SB-2853-01	75	13
SB-2853-02	100	22
SB-2853-03	120	25

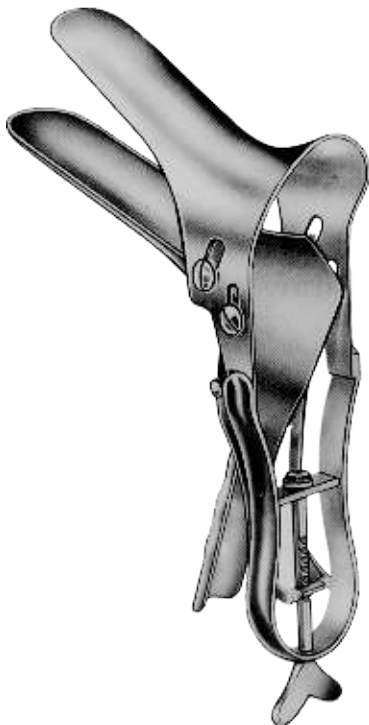

Sayfert	a mm	b mm
SB-2854-01	100	17
SB-2854-02	1010	33

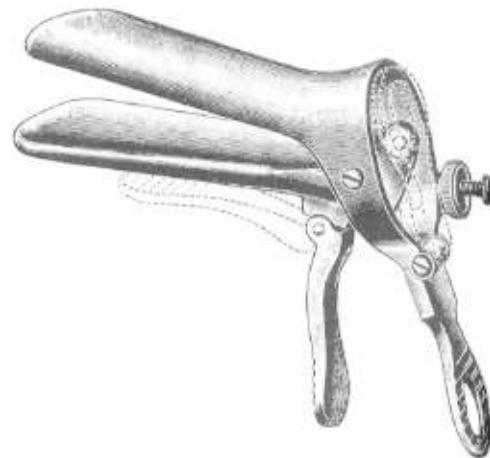

SB-2855-01	small, klein, petit, pequeño
SB-2855-02	medeum, medeum, medeum
SB-2855-03	large, groß, grand, grande

## Gynecology Instruments

Vaginal Speculas  
Vaginal Speculas

Speculas vaginales  
espéculos vaginales

Scheme of Dimensions for Specula  
Schema Abmessungen für Spekula  
Schéma des dimensions de spéculums  
Esquema de Medidas para espéculos

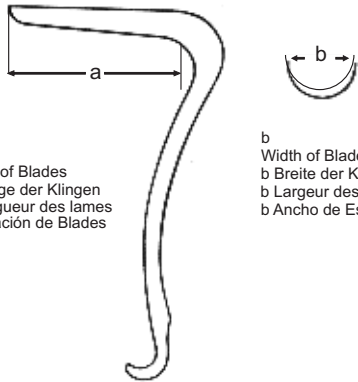

a  
Length of Blades  
ein Länge der Klängen  
un Longueur des lames  
un Duración de Blades

b  
Width of Blades  
b Breite der Klängen  
b Largeur des lames  
b Ancho de Espadas



**Sims**

SB-2856-01 63 x 32 mm  
SB-2856-02 76 x 32 mm  
SB-2856-03 89 x 38 mm

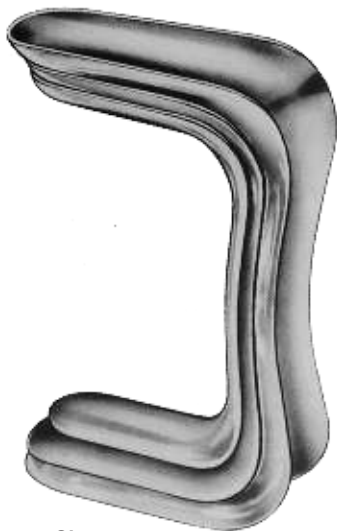

**Sims**

	Fig	a mm	b mm
SB-2857-00			
SB-2857-01	1	60	25+30
SB-2857-02	2	70	30+35
SB-2857-03	3	80	35+40



**Jackson**

Fig.1 75 x 35 SB-2858-01  
Fig. 2 90 x 35 SB-2858-02  
Fig. 3 100 x 35 SB-2858-03

	Fig.	a mm	b mm
SB-2858-04	4	75 X 40	
SB-2858-05	5	90 X 40	
SB-2858-06	6	100 X 40	

## Gynecology Instruments

Vaginal Speculas  
Vaginal Speculas

Speculas vaginales  
espéculos vaginales



**Eastman**

	Fig.	a mm	b mm
SB-2859-01	1	76	38
SB-2859-02	2	89	38
SB-2859-03	3	101	38



For children  
für Kinder  
pour les enfants  
Para los niños

Set  
setzen  
fixer  
establecer

**Kristeller**  
SB-2860-00  
70x15 mm



Specula

Retractor

**Kristeller**  
(Standard)

Set of 1 specula and 1 retractor  
Set 1 Spekula und 1 Retraktor  
Set de 1 spéculums et 1 enrrouleur  
1 Juego de espéculos y retractor 1

Fig. 1 SB-2861-00  
Fig. 2 SB-2862-00  
Fig. 3 SB-2863-00

**Specula**

	Fig.	a mm	b mm
SB-2861-01	1	70	27
SB-2862-01	2	80	30
SB-2863-01	3	90	36

**Retractors**

	Fig.	a mm	b mm
SB-2861-02	1	75	23
SB-2862-02	2	85	26
SB-2863-02	3	100	32



## Gynecology Instruments

Vaginal Speculas  
Vaginal Speculas

Speculas vaginales  
especulos vaginales

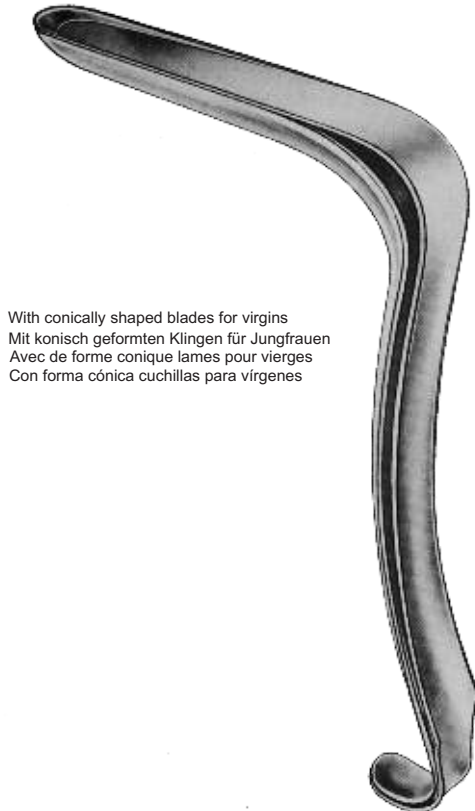

With conically shaped blades for virgins  
Mit konisch geformten Klingen für Jungfrauen  
Avec de forme conique lames pour vierges  
Con forma cónica cuchillas para vírgenes

**Kristeller**



With extra long blades  
Mit extra langen Klingen  
Avec de longues lames supplémentaires  
Con extra largas hojas

**Kristeller  
(Standard)**

Set of 1 specula and 1 retractor  
Set 1 Spekula und 1 Retraktor  
Set de 1 spéculums et 1 enrouleur  
1 Juego de especulos y retractor 1

Fig. 00 SB-2864-00

Fig. 0 SB-2865-00

### Specula

	Fig.	a	b
		mm	mm
SB-2864-01	00	110	18
SB-2865-01	0	110	21

### Retractors

	Fig.	a	b
		mm	mm
SB-2864-02	00	115	14
SB-2865-02	0	115	17

Set of 1 specula and 1 retractor  
Set 1 Spekula und 1 Retraktor  
Set de 1 spéculums et 1 enrouleur  
1 Juego de especulos y retractor 1

Fig. 1 SB-2866-00

Fig. 2 SB-2867-00

Fig. 3 SB-2868-00

### Specula

	Fig.	a	b
		mm	mm
SB-2866-01	1	110	27
SB-2867-01	2	110	30
SB-2868-01	3	110	36

### Retractors

	Fig.	a	b
		mm	mm
SB-2866-02	1	115	23
SB-2867-02	2	115	26
SB-2868-02	3	115	32



## Gynecology Instruments

Vaginal Speculas  
Vaginal Speculas

Speculas vaginales  
espéculos vaginales



With flat hollow specula  
Mit flachen Talkessel Spekula  
Avec spéculums à plat creux  
Con espéculos cuenca llana

Set of 1 specula and 1 retractor  
Set 1 Spekula und 1 Retraktor  
Set de 1 spéculums et 1 enrouleur  
1 Juego de espéculos y retractor 1

Fig. 1 SB-2869-00  
Fig. 2 SB-2870-00  
Fig. 3 SB-2861-00

### Specula

	Fig.	a	b	
		mm	mm	
	SB-2869-01	1	105	26
	SB-2870-01	2	105	28
	SB-2871-01	3	105	33

### Retractors

	Fig.	a	b	
		mm	mm	
	SB-2869-02	1	115	22
	SB-2870-02	2	115	24
	SB-2871-02	3	115	29

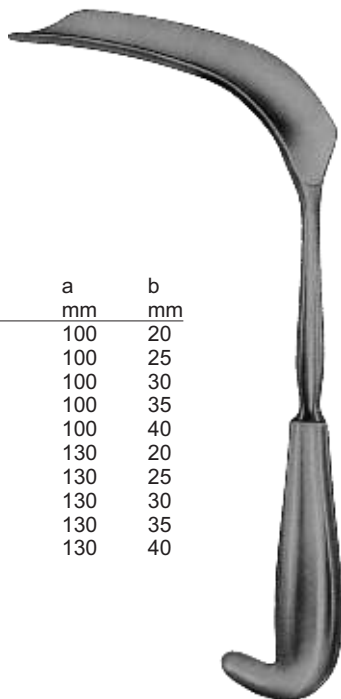

	a	b
	mm	mm
SB-2872-20	100	20
SB-2872-25	100	25
SB-2872-30	100	30
SB-2872-35	100	35
SB-2872-40	100	40
SB-2872-20	130	20
SB-2872-25	130	25
SB-2872-30	130	30
SB-2872-35	130	35
SB-2872-40	130	40

Matzenauer



**Braun**  
SB-2873-18  
18 cm/7"  
56x13 mm

## Gynecology Instruments

Vaginal Speculas  
Vaginal Speculas

Speculas vaginales  
especulos vaginales



**Braun**  
SB-2874-18  
18 cm/7"  
60x10 mm



**Ulrich**  
SB-2875-19  
19.5 cm/7 1/2"  
80x20 mm



SB-2876-19  
19 cm/7 1/2"  
85x17 mm

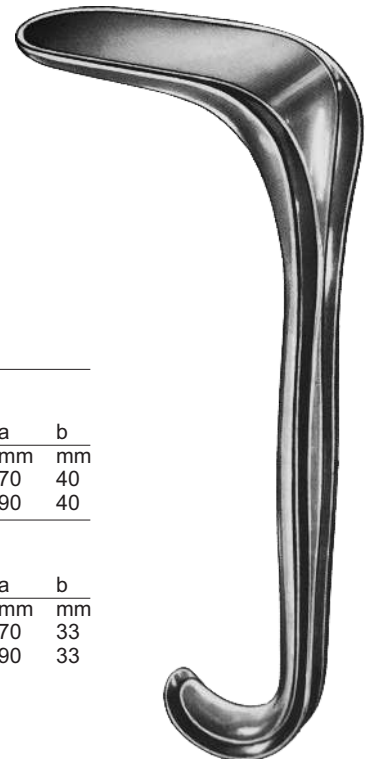

**Kallmorgen**

**Set**

SB-2877-00 Fig. 1  
SB-2878-00 Fig. 2

**Specula**

	Fig.	mm	
		a	b
SB-2877-01	1	70	40
SB-2878-01	2	90	40

**Retractors**

	Fig.	mm	
		a	b
SB-2877-02	1	70	33
SB-2878-02	2	90	33

## Gynecology Instruments

Vaginal Speculas  
Vaginal Speculas

Speculas vaginales  
especulos vaginales

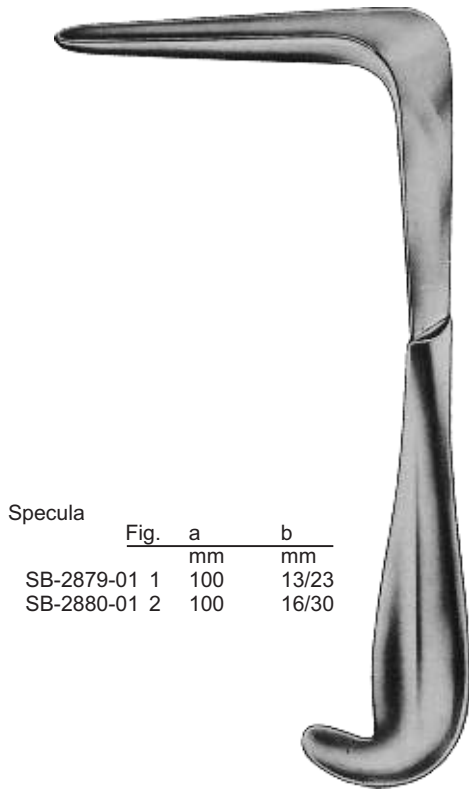

Specula	Fig.	a	b
		mm	mm
SB-2879-01	1	100	13/23
SB-2880-01	2	100	16/30

**Mathieu**

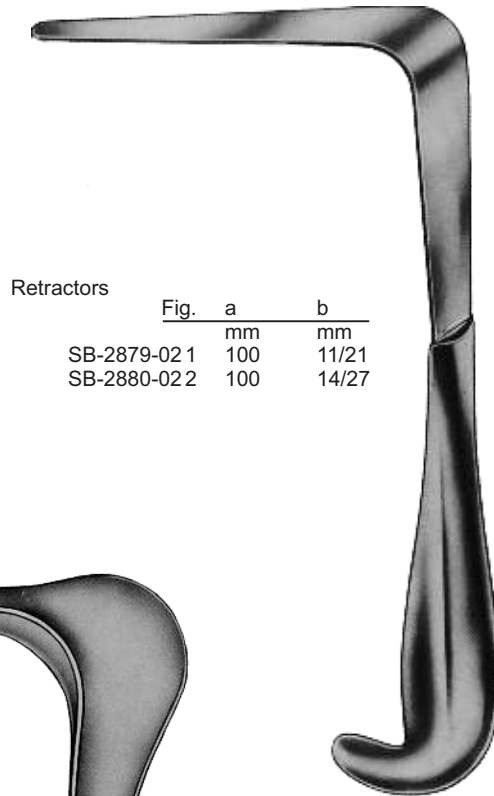

Retractors	Fig.	a	b
		mm	mm
SB-2879-02	1	100	11/21
SB-2880-02	2	100	14/27

Set	Fig.	SB-2881-01
		SB-2881-02
	Fig. 1	SB-2881-01
	Fig. 2	SB-2881-02

**Mathieu**

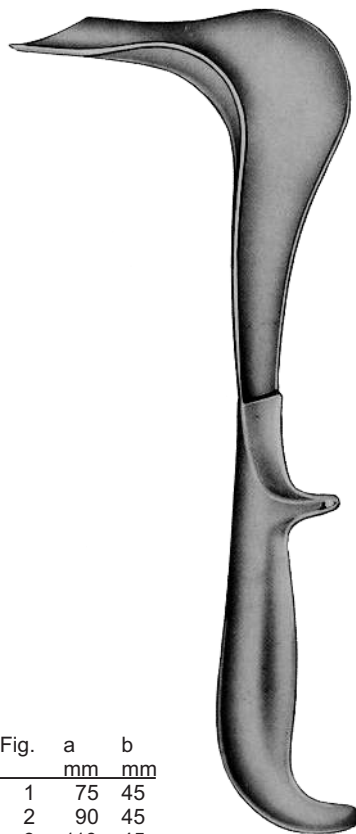

Fig.	a	b
	mm	mm
SB-2882-01	75	45
SB-2882-02	90	45
SB-2882-03	110	45

**Doyen**

## Gynecology Instruments

Vaginal Speculas  
Vaginal Speculas

Speculas vaginales  
especulos vaginales



**Doyen**  
24 cm/9 1/2"  
slightly-concave  
leicht konkav-  
légèrement concave  
ligeramente cóncava

	Fig.	a mm	b mm	
SB-2883-01	1	55	35	SB-2886-01
SB-2883-02	2	85	35	SB-2886-02
SB-2883-03	3	115	35	SB-2886-03
SB-2884-01	1	55	45	SB-2887-01
SB-2884-02	2	85	45	SB-2887-02
SB-2884-03	3	115	45	SB-2887-03
SB-2884-04	4	160	45	
SB-2884-05	5	180	45	
SB-2885-01	1	55	60	SB-2888-01
SB-2885-02	2	85	60	SB-2888-02
SB-2885-03	3	115	60	SB-2888-03
SB-2885-04	4	160	60	
SB-2885-05	5	180	60	

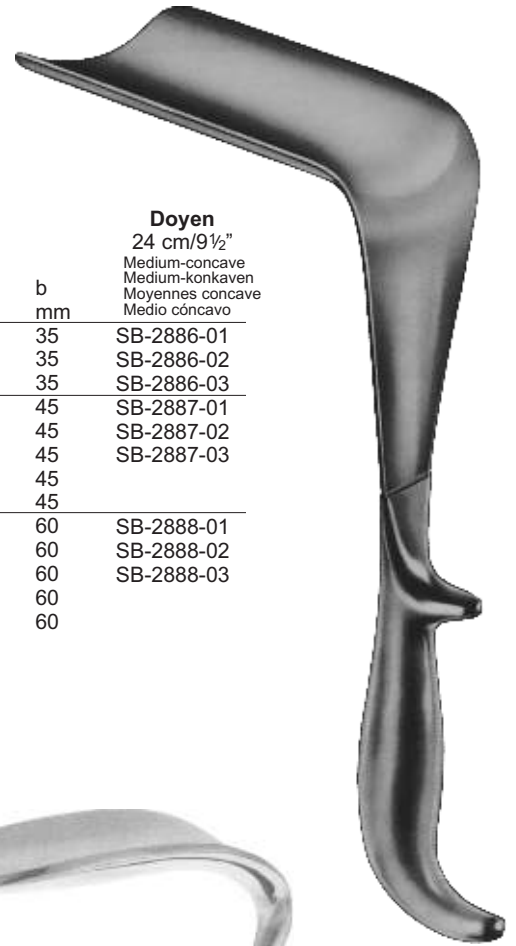

**Doyen**  
24 cm/9 1/2"  
Medium-concave  
Medium-konkaven  
Moyennes concave  
Medio cóncavo



**Doyen**  
25 cm/10"

	a mm	b mm
SB-2889-01	60	30
SB-2889-02	70	30
SB-288-03	80	30



**Mangiagalli**  
SB-2890-00  
40 x 80 mm

## Gynecology Instruments

Vaginal Speculas  
Vaginal Speculas

Speculas vaginales  
especúlos vaginales



### Auvard

with removable weight  
mit abnehmbarem Gewicht  
avec un poids amovible  
con peso extraíble

SB-2891-01  
80x38mm  
SB-2891-02  
105x42mm

### Auvard

with fixed weight  
mit festem Gewicht  
avec un poids fixe  
con peso fijo

SB-2892-01  
80x38 mm  
SB-2892-02  
105x42 mm

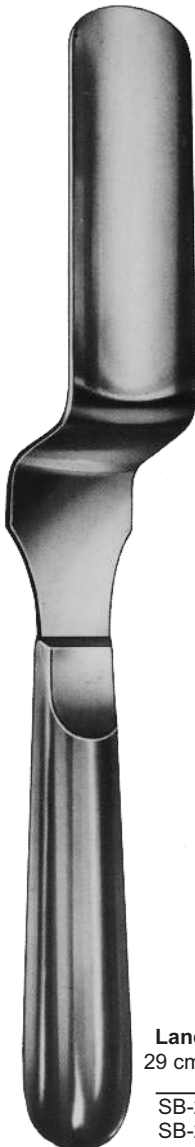

**Landau**  
29 cm/11½"

	a	b
	mm	mm
SB-2893-01	100	28
SB-2893-02	100	38



### Breisky

	a	b
	mm	mm
SB-2894-20	100	20
SB-2894-25	100	25
SB-2894-30	100	30
SB-2894-35	100	35
SB-2894-40	100	40
SB-2895-20	130	20
SB-2895-25	130	25
SB-2895-30	130	30
SB-2895-35	130	35
SB-2895-40	130	40
SB-2896-20	160	20
SB-2896-25	160	25
SB-2896-30	160	30
SB-2896-35	160	35
SB-2896-40	160	40
SB-2897-20	180	20
SB-2897-25	180	25
SB-2897-30	180	30
SB-2897-35	180	35
SB-2897-40	180	40

## Gynecology Instruments

Vaginal Speculas and Retractors  
Vaginal Speculas und Retraktoren

Speculas vaginaux et rétracteurs  
Especulos vaginales y retractores



Bozemann  
SB-2898-00

Complete



SB-2898-05  
80 x 30 mm



SB-2898-01  
65 x 30 mm



SB-2898-06  
85 x 33 mm



SB-2898-02  
75 x 35 mm



SB-2898-07  
100 x 38 mm



SB-2898-03  
85 x 35 mm



SB-2898-08  
110 x 42 mm



SB-2898-04  
95 x 35 mm

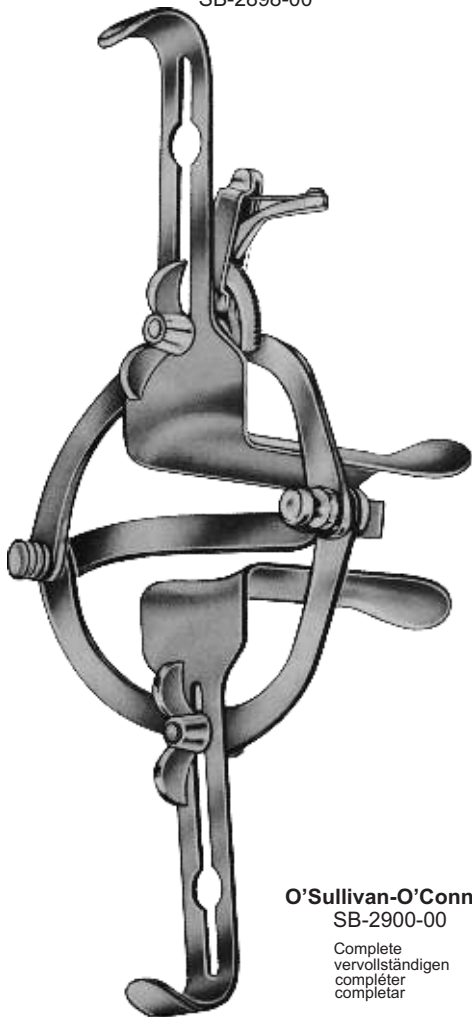

O'Sullivan-O'Connor  
SB-2900-00

Complete  
vervollständigen  
compléter  
completar

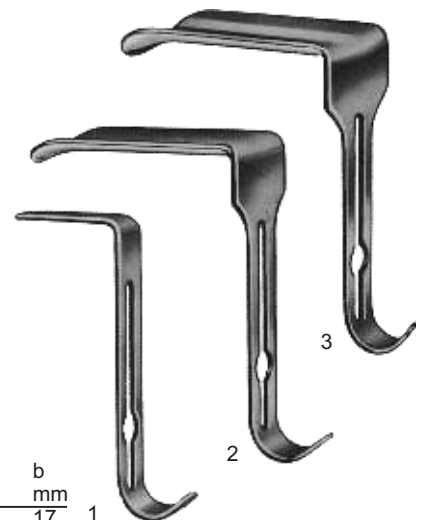

	Fig.	a mm	b mm
SB-2900-01	1	45	17
SB-2900-02	2	90	37
SB-2900-03	3	90	45

## Gynecology Instruments

Uterine Dilators

Dilatateurs utérins

Uterus-Dilatatoren

dilatadores uterinos



Hegar

mmØ	mmØ
1.0 SB-2901-01	1.5 SB-2902-01
2.0 SB-2901-02	2.5 SB-2902-02
3.0 SB-2901-03	3.5 SB-2902-03
4.0 SB-2901-04	4.5 SB-2902-04
5.0 SB-2901-05	5.5 SB-2902-05
6.0 SB-2901-06	6.5 SB-2902-06
7.0 SB-2901-07	7.5 SB-2902-07
8.0 SB-2901-08	8.5 SB-2902-08
9.0 SB-2901-09	9.5 SB-2902-09
10.0 SB-2901-10	10.5 SB-2902-10
11.0 SB-2901-11	11.5 SB-2902-11
12.0 SB-2901-12	12.5 SB-2902-12
13.0 SB-2901-13	13.5 SB-2902-13
14.0 SB-2901-14	14.5 SB-2902-14
15.0 SB-2901-15	15.5 SB-2902-15
16.0 SB-2901-16	16.5 SB-2902-16
17.0 SB-2901-17	17.5 SB-2902-17
18.0 SB-2901-18	18.5 SB-2902-18
19.0 SB-2901-19	19.5 SB-2902-19
20.0 SB-2901-20	
21.0 SB-2901-21	
22.0 SB-2901-22	
23.0 SB-2901-23	
24.0 SB-2901-24	
25.0 SB-2901-25	
26.0 SB-2901-26	
27.0 SB-2901-27	
28.0 SB-2901-28	
29.0 SB-2901-29	
30.0 SB-2901-30	

	Pieces per set	set
SB-2903-40	14 4.0-17.0 mm	In canvas
SB-2903-50	14 4.0-17.0 mm	In metal case
SB-2903-60	26 1.0-26.0 mm	in canvas
SB-2903-70	26 1.0-26.0 mm	in metal case



Hegar

Ø mm	
1.0/2.0	SB-2903A-02
3.0/4.0	SB-2903A-04
5.0/6.0	SB-2903A-06
7.0/8.0	SB-2903A-08
9.0/10.0	SB-2903A-10
11.0/12.0	SB-2903A-12
13.0/14.0	SB-2903A-14
15.0/16.0	SB-2903A-16
17.0/18.0	SB-2903A-18
19.0/20.0	SB-2903A-20
21.0/22.0	SB-2903A-22
23.0/24.0	SB-2903A-24
25.0/26.0	SB-2903A-26

	Pieces per set	set
SB-2904-40	08 3.0/4.0-17.0/18.0 mm	
SB-2904-60	13 1.0/2.0-25.0/26.0 mm	
SB-2904-50	08 3.0/4.0-17.0/18.0 mm	
SB-2904-70	13 1.0/2.0-25.0/26.0 mm	



## Gynecology Instruments

Uterine Dilators  
Uterus-Dilatatoren

Dilatateurs utérins  
dilatadores uterinos



**Pratt**

Fig.	mm	
13/15	4.5/5.0	SB-2905-15
17/19	5.6/6.3	SB-2905-19
21/23	7.0/7.6	SB-2905-23
25/27	8.3/9.0	SB-2905-27
29/31	9.6/10.3	SB-2905-31
33/35	11.0/11.6	SB-2905-35
37/39	12.3/13.0	SB-2905-39
41/43	13.6/14.3	SB-2905-43

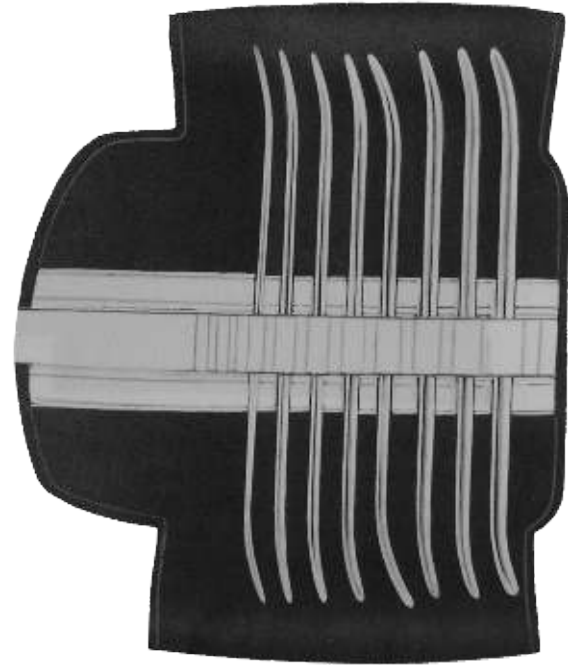

Set  
SB-2905-00



**Hank**  
20-2706-00

Fig.	mm	
9/10	4.5/5	SB-2906-10
11/12	5.5/6	SB-2906-12
13/14	6.5/7	SB-2906-14
15/16	7.5/8	SB-2906-16
17/18	8.5/9	SB-2906-18
19/20	9.5/10	SB-2906-20

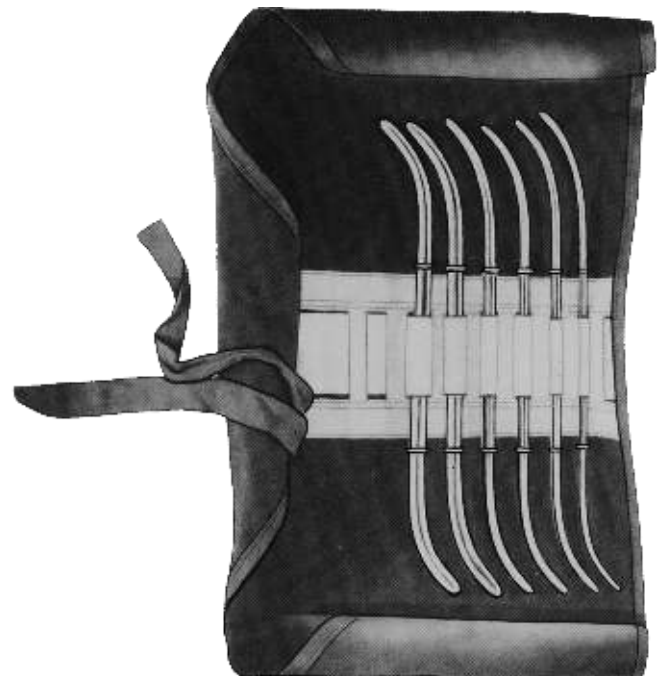

Set

## Gynecology Instruments

Uterine Tenaculum Forceps, Amniotome  
Uterine Hakchen Pinzette, Amniotome

Tenaculum uterine Forceps, amniotomie  
Uterina tenaculo pinzas, Amniotome



**Sims**  
SB-2907-33  
33 cm/13"



**Sims**  
SB-2908-33  
33 cm/13"



**Walleix**  
SB-2909-29  
29.5 cm/11 1/2"



**Braun**  
SB-2910-27  
27.5 cm/11 3/4"

## Gynecology Instruments

Uterine Sounds, Uterine Depressor  
Uterus-Sounds, Uterus-Depressor

Sons utérins, de l'utérus dépresseurs  
Los sonidos uterinos, útero depresores



**Schröder**  
SB-2911-25  
25.5 cm/10 "



**Duply**  
SB-2912-25  
25.5 cm/10 "

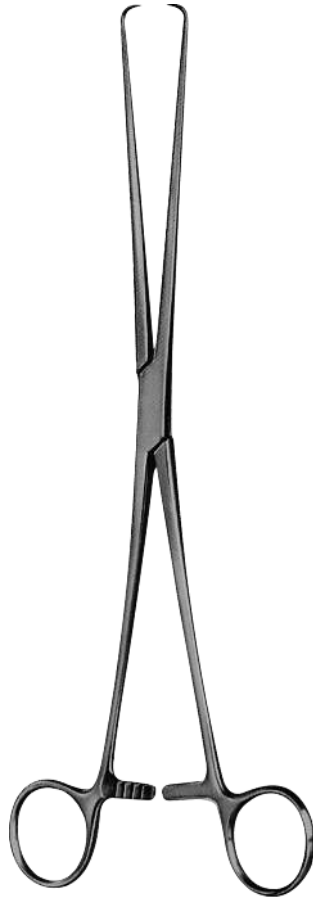

**Braun**  
SB-2913-25  
25 cm/10 1/4"



**Beacham**  
SB-2914-26  
26 cm/10 1/4"

## Gynecology Instruments

Uterine Tenaculum Forceps  
Uterine Tenakulum Zange

Utérine Forceps tenaculum  
Pinza uterina tenáculo

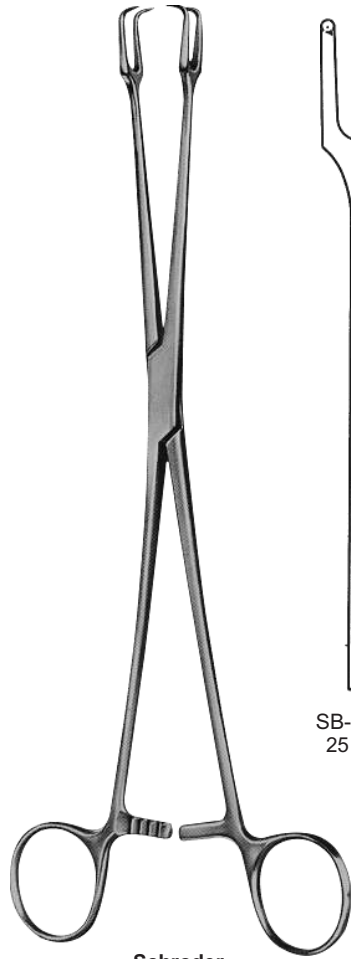

Schroder

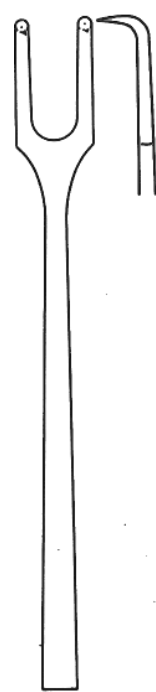

SB-2915-25  
25 cm/9 <sup>3</sup>/<sub>4</sub>"

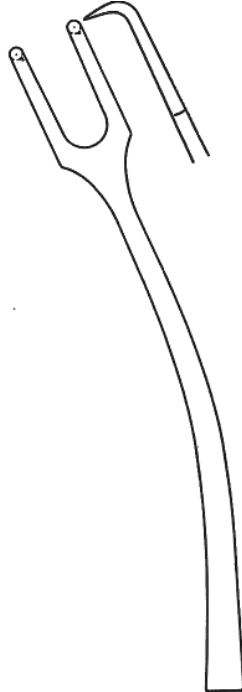

SB-2916-23  
23.5 cm/9 <sup>1</sup>/<sub>4</sub>"



Skene  
SB-2917-24  
24 cm/9 <sup>1</sup>/<sub>2</sub>"



Teale  
SB-2918-23  
23.5 cm/9 <sup>1</sup>/<sub>4</sub>"

## Gynecology Instruments

Uterine Tenaculum Forceps  
Uterine Tenakulum Zange

Utérine Forceps tenaculum  
Pinza uterina tenáculo



IOWA



SB-2919-26  
26 cm/10 1/4"

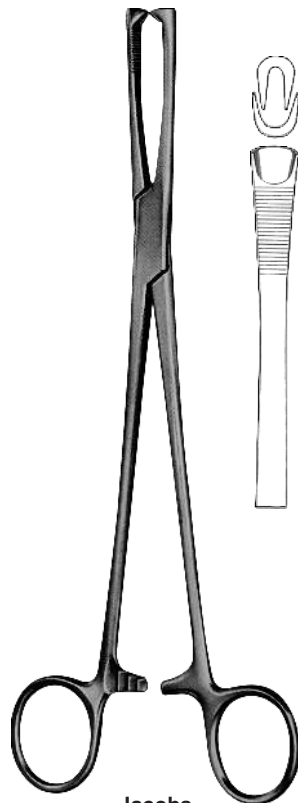

JACOBS



SB-2923-21  
21 cm/8 1/4"

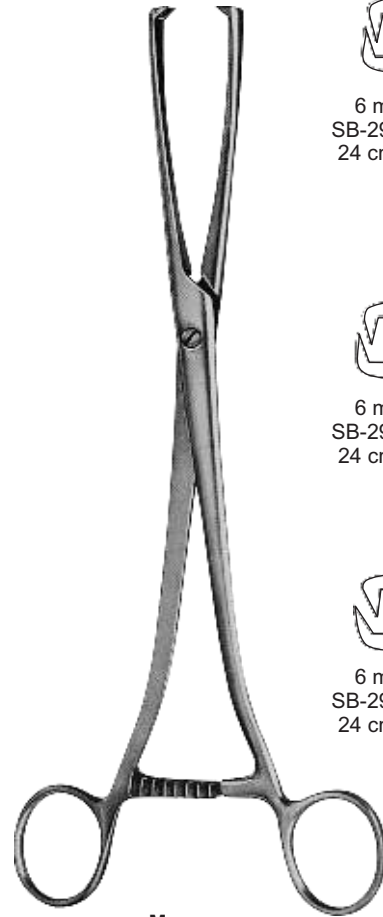

MUSEUX



6 mm  
SB-2910-24  
24 cm/9 1/2"



6 mm  
SB-2921-24  
24 cm/9 1/2"



6 mm  
SB-2922-24  
24 cm/9 1/2"

## Gynecology Instruments

Uterine Tenaculum Forceps  
Uterine Tenakulum Zange

Utérine Forceps tenaculum  
Pinza uterina tenáculo

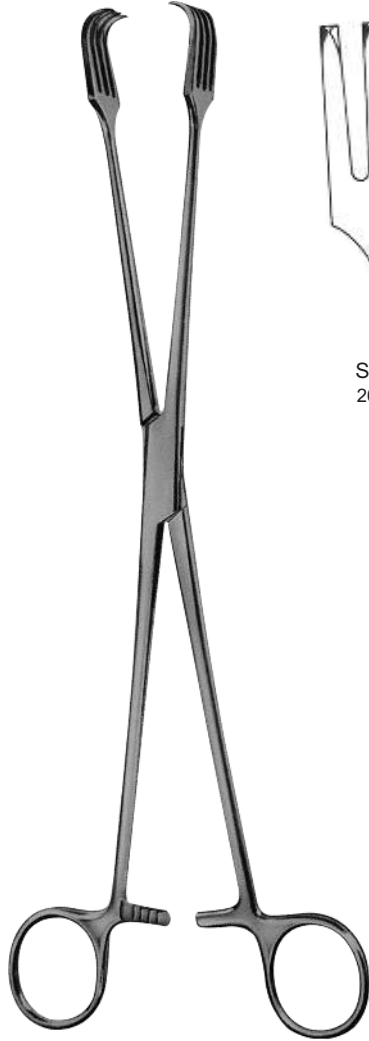

SB-2924-26  
26.5 cm/10 1/2"

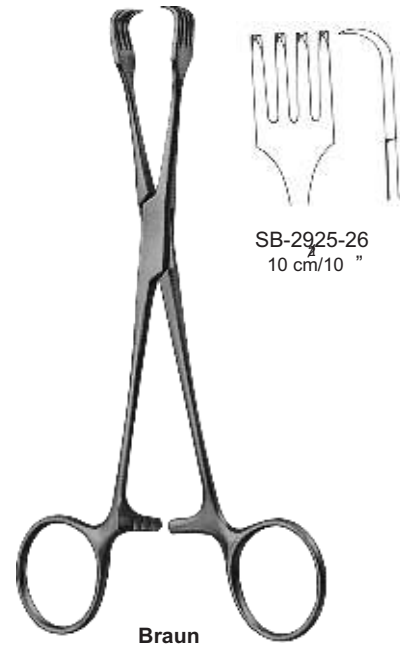
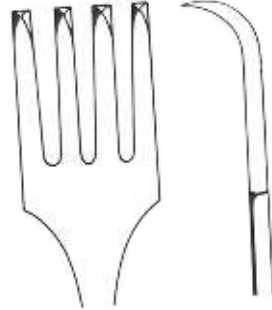

SB-2925-26  
10 cm/10 "

Braun



SB-2926-21  
21 cm/8 1/4"

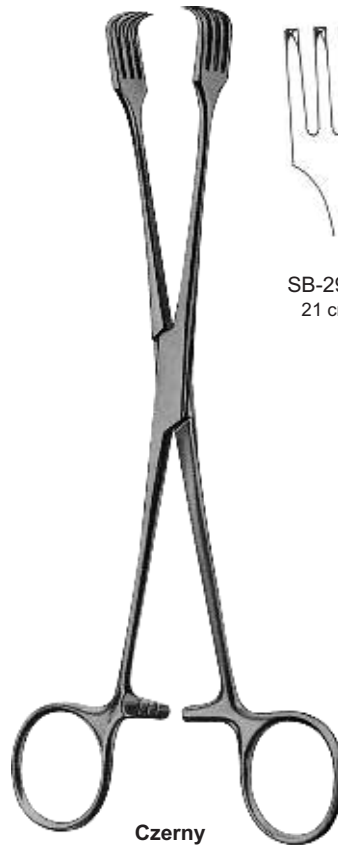

Czerny

## Gynecology Instruments

Uterine Pulypus Forceps  
Uterine Pulypus Zange

Utérine Pulypus Forceps  
Pinza uterina Pulypus

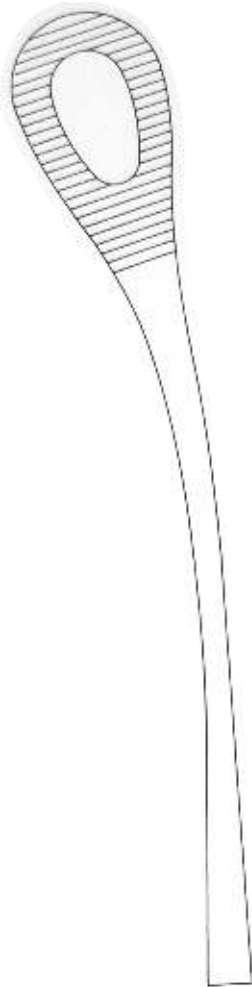

SB-2927-32  
32 cm/12½"

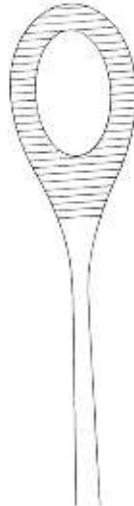

SB-2928-27  
27 cm/10¼"

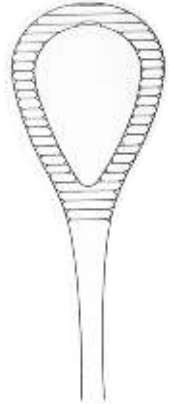

SB-2929-25  
25 cm/9¾"



## Gynecology Instruments

Myoma Screws, Myoma Knife  
Schrauben Myome, Myome Knife

Vis myome, couteaux myomes  
Tornillos, mioma Mioma Knife



**Doyen**  
SB-2930-17  
17 cm/6 3/4"



**Doyen**  
SB-2931-14  
14.5 cm/5 3/4"



**Segand**



SB-2932-28  
28 cm/11"

3/4

## Gynecology Instruments

Uterine Seizing Forceps  
Uterine ergriff Zange

Utérins Forceps Saisir  
Uterinos Pinzas Aprovechar

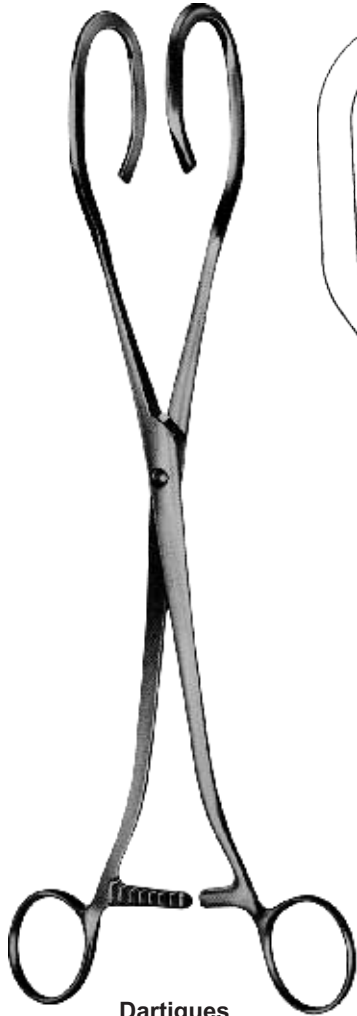

**Dartigues**  
SB-2933-25  
28 cm/11"

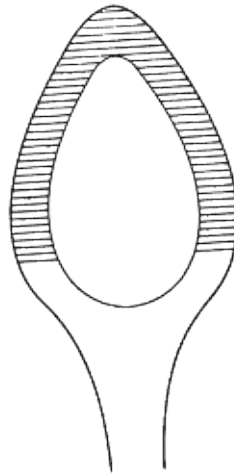
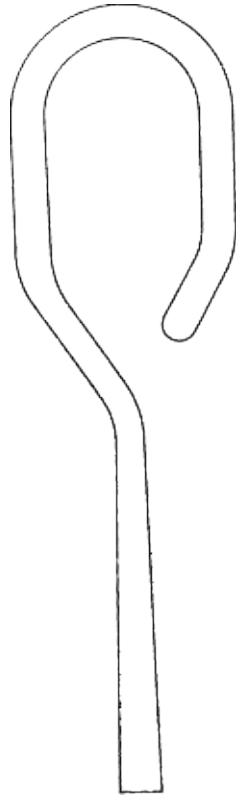

**Somer**  
SB-2934-25  
22.5 cm/8 3/4"

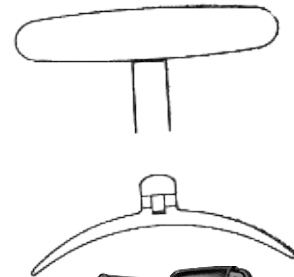

**Collin**  
SB-2935-26  
26 cm/10 1/4"

## Gynecology Instruments

Fistula Hooks  
Fistula Haken

Crochets fistule  
Ganchos fistula

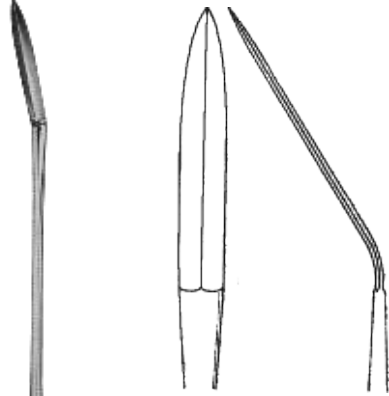

SB-2936-23  
23.5 cm/9 1/4"

Ayre



SB-2937-23  
22 cm/9 3/4"

Emmett



SB-2938-21  
21.5cm/8 1/2"

Simon



SB-2939-21  
21.5cm/8 1/2"

Simon

## Gynecology Instruments

Suction Curettes, Uterine Biopsy Curettes  
Saug-Küretten, Uterus-Biopsie Küretten

Curettes d'aspiration, de l'utérus biopsie Curettes  
Curetas de aspiración, biopsia uterina Curetas

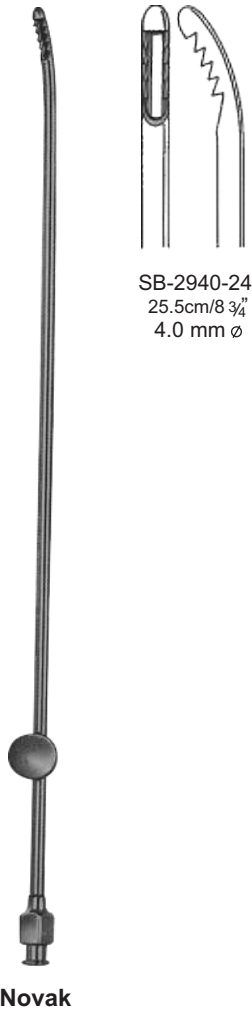

## Gynecology Instruments

Uterine Biopsy Forceps  
Uterine Biopsiezangen

Pince à biopsie utérine  
Pinzas de biopsia uterina

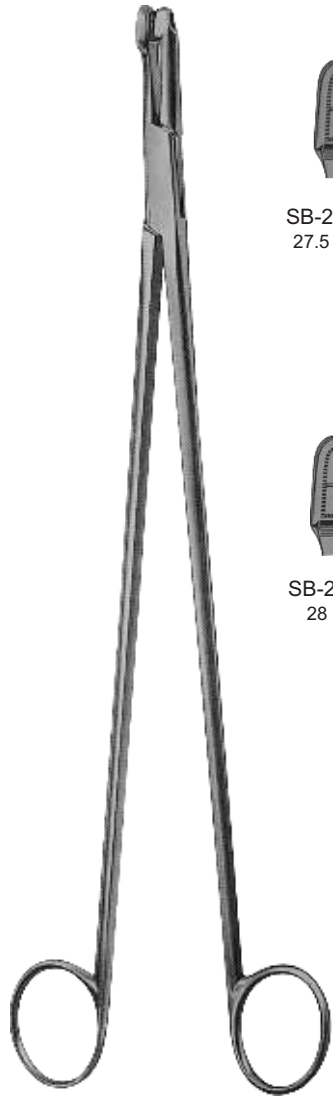

Schubert

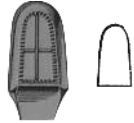

SB-2943-21  
27.5 cm/8 1/2"

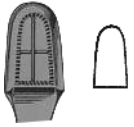

SB-2943-28  
28 cm/11"



Faure



SB-2944-21  
21 cm/8 1/4"



Gellhorn



SB-2945-24  
24 cm/8 1/2"

## Gynecology Instruments

Uterine Biopsy Forceps  
Uterine Biopsiezangen

Pince à biopsie utérine  
Pinzas de biopsia uterina



SB-2946-21  
21 cm/8 1/4"

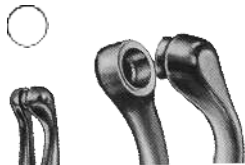

SB-2946-23  
23.5 cm/9 1/4"

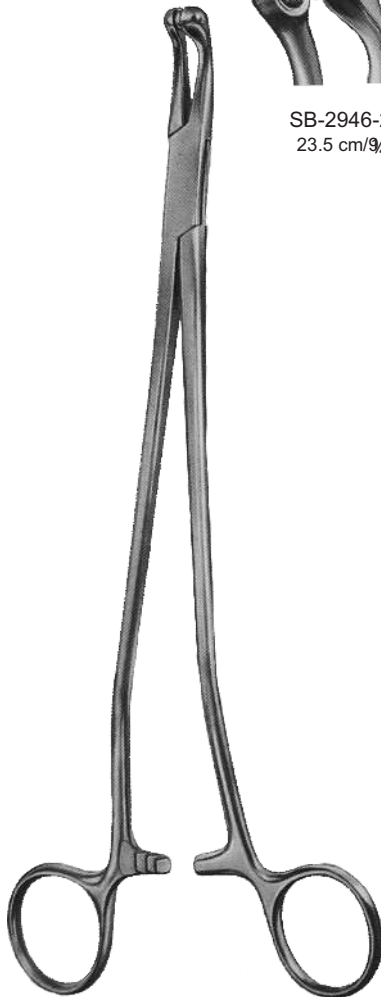

Thoms-Gaylor



Schubert

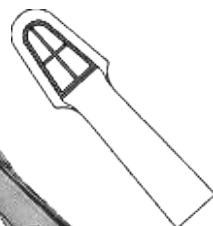

SB-2947-25  
25.5 cm/10"



Van Doren



SB-2948-27  
27cm/10 3/4"

### Gynecology Instruments

Uterine Biopsy Forceps  
Uterine Biopsiezangen

Pince à biopsie utérine  
Pinzas de biopsia uterina

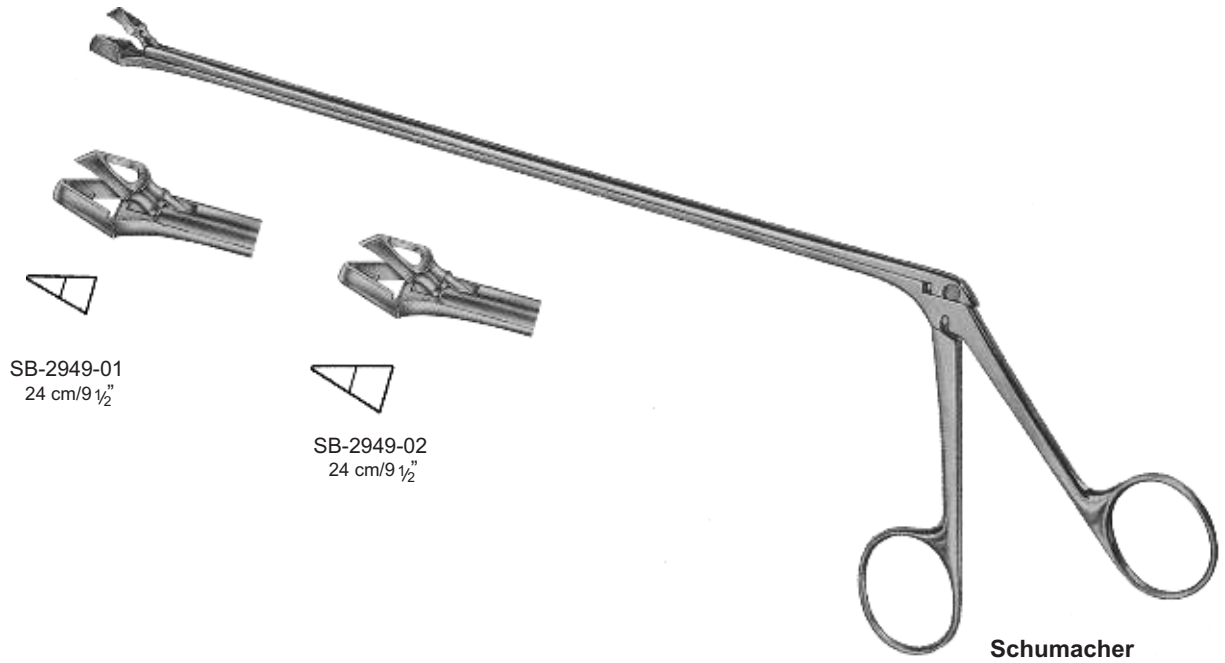



## Gynecology Instruments

Uterine Biopsy Forceps  
Uterine Biopsiezangen

Pince à biopsie utérine  
Pinzas de biopsia uterina



SB-2951-25  
25.5 cm/10"

Van Doren

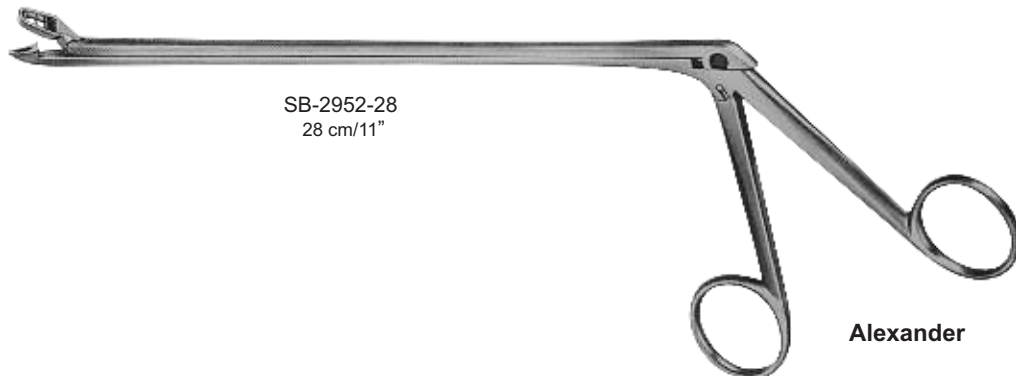

SB-2952-28  
28 cm/11"

Alexander

## Gynecology Instruments

Uterine Biopsy Forceps, IUP Grasping Forceps  
Uterine Biopsiezangen, IUP Faßzange

Utérine pincés à biopsie, pincés à préhension IUP  
Uterina pinzas de biopsia, Pinzas IUP Agarre

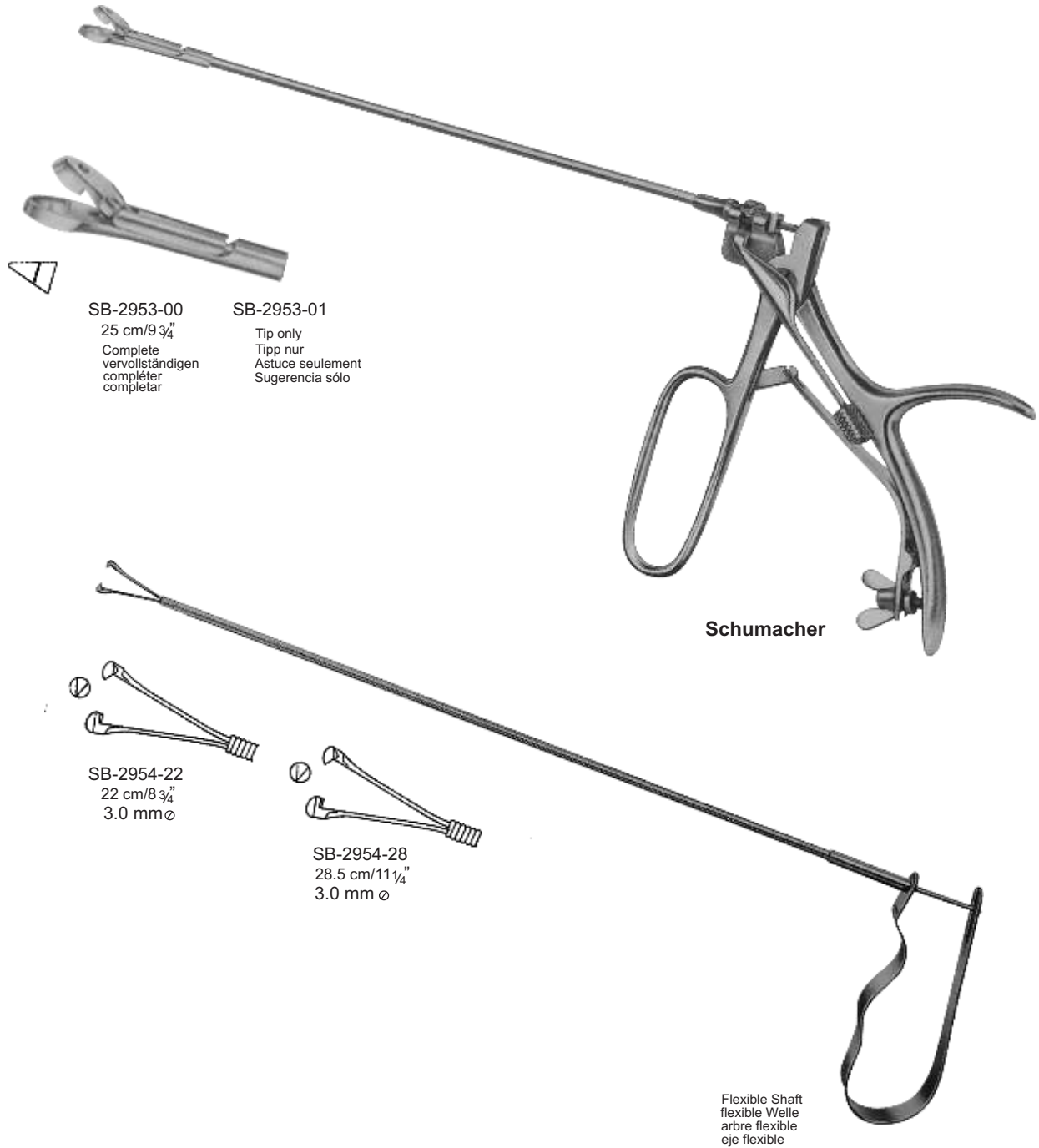

## Gynecology Instruments

Uterine Scoops  
Uterine Scoops

utérine Scoops  
uterina Scoops



9,8 x 6,8 mm  
SB-2945-01  
24.5 cm/9 3/4"



9,8 x 6,8 mm  
SB-2956-01  
24.5 cm/9 3/4"



11,6 x 8,3 mm  
SB-2955-02  
24.5 cm/9 3/4"



11,6 x 8,3 mm  
SB-2956-02  
24.5 cm/9 3/4"



13,2 x 10,0 mm  
SB-2955-03  
24.5 cm/9 3/4"



13,2 x 10,0 mm  
SB-2956-03  
24.5 cm/9 3/4"



16,0 x 11,6 mm  
SB-2955-04  
24.5 cm/9 3/4"



16,0 x 11,6 mm  
SB-2956-04  
24.5 cm/9 3/4"



18,0 x 12,6 mm  
SB-2955-05  
24.5 cm/9 3/4"



18,0 x 12,6 mm  
SB-2956-05  
24.5 cm/9 3/4"



20,0 x 13,8 mm  
SB-2955-06  
24.5 cm/9 3/4"



20,0 x 13,8 mm  
SB-2956-06  
24.5 cm/9 3/4"



Simon



Simon

## Gynecology Instruments

Uterine Curettes      Curettes utérines  
Uterus-Küretten      Curetas uterinas



**Recamier**  
SB-2957-05  
SB-2957-40



**Recamier**  
SB-2958-05  
SB-2958-40



**Sims**  
SB-2959-05  
SB-2959-40



**Sims**  
SB-2960-05  
SB-2960-40

Fig	mm	SB-2957-05	SB-2958-05	SB-2959-05	SB-2960-05
00	5	SB-2957-05	SB-2958-05	SB-2959-05	SB-2960-05
0	6	SB-2957-06	SB-2958-06	SB-2959-06	SB-2960-06
1	7	SB-2957-09	SB-2958-07	SB-2959-07	SB-2960-07
2	8	SB-2957-10	SB-2958-08	SB-2959-08	SB-2960-08
3	9	SB-2957-12	SB-2958-09	SB-2959-09	SB-2960-09
4	10	SB-2957-14	SB-2958-10	SB-2959-10	SB-2960-10
5	12	SB-2957-15	SB-2958-12	SB-2959-12	SB-2960-12
6	14	SB-2957-16	SB-2958-14	SB-2959-14	SB-2960-14
7	15	SB-2957-19	SB-2958-15	SB-2959-15	SB-2960-15
8	16	SB-2957-20	SB-2958-16	SB-2959-16	SB-2960-16
9	19	SB-2957-21	SB-2958-19	SB-2959-19	SB-2960-19
10	20	SB-2957-23	SB-2958-20	SB-2959-20	SB-2960-20
11	21	SB-2957-25	SB-2958-21	SB-2959-21	SB-2960-21
12	23	SB-2957-30	SB-2958-23	SB-2959-23	SB-2960-23
13	25	SB-2957-35	SB-2958-25	SB-2959-25	SB-2960-25
14	30	SB-2957-40	SB-2958-30	SB-2959-30	SB-2960-30
15	35		SB-2958-35	SB-2959-35	SB-2960-35
16	40		SB-2958-40	SB-2959-40	SB-2960-40

## Gynecology Instruments

Uterine Curettes  
Uterus-Küretten

Curettes utérines  
Curetas uterinas



Fig. 00  
5 mm  
31 cm/12 1/4"  
SB-2961-05



Fig. 0  
6 mm  
31 cm/12 1/4"  
SB-2961-06



Fig. 1  
7 mm  
31 cm/12 1/4"  
SB-2961-07



Fig. 2  
8 mm  
31 cm/12 1/4"  
SB-2961-08



Fig. 3  
9 mm  
31 cm/12 1/4"  
SB-2961-09



Fig. 4  
11 mm  
31 cm/12 1/4"  
SB-2961-11



Fig. 5  
12 mm  
31 cm/12 1/4"  
SB-2961-12



Fig. 6  
14 mm  
31 cm/12 1/4"  
SB-2961-14



Fig. 7  
15 mm  
31 cm/12 1/4"  
SB-2961-15



Fig. 8  
16 mm  
31 cm/12 1/4"  
SB-2961-16



Fig. 9  
19 mm  
31 cm/12 1/4"  
SB-2961-19



Fig. 10  
20 mm  
31 cm/12 1/4"  
SB-2961-20



Fig. 11  
21 mm  
31 cm/12 1/4"  
SB-2961-21



Fig. 12  
23 mm  
31 cm/12 1/4"  
SB-2961-23



Fig. 13  
25 mm  
34 cm/13 1/2"  
SB-2961-25



Fig. 14  
30 mm  
35 cm/12 3/4"  
SB-2961-30



Fig. 15  
35 mm  
35 cm/12 3/4"  
SB-2961-35



Fig. 16  
40 mm  
35 cm/12 3/4"  
SB-2961-40



*Serving Health Care*

# **SPEED BIRD**

## **ENTERPRISES**



**161/C, SMALL INDUSTRIAL ESTATE  
SIALKOT-51310, (PAKISTAN)**



**: +92-304 0549944**



**: +92-52-3555584**



**: speed@birddent.com**



**: www.birddent.com**