



Serving Health Care

SPEED BIRD
ENTERPRISES

www.birddent.com

**KIDNEY, LIVER
AND GALL STONE INSTRUMENTS**

SECTION

19

Kidney, Liver and Gall Stone Instruments

Kidney Pedicle Clamps Forceps
Kidney Gestielte Klemmen Pinzetten

Rein péculaires Forceps Pincés
Pinzas Pinzas renales pediculares

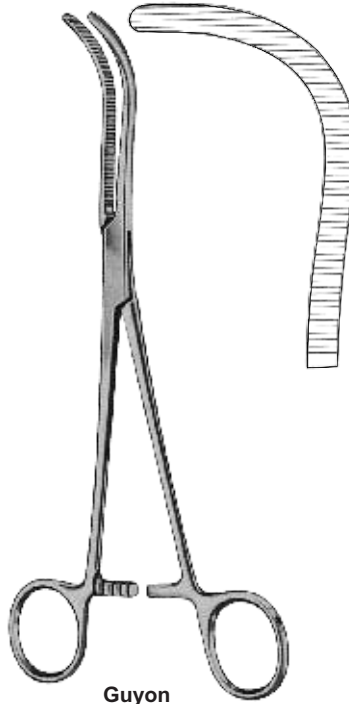

Guyon
SB-2776-23
23 cm/9"

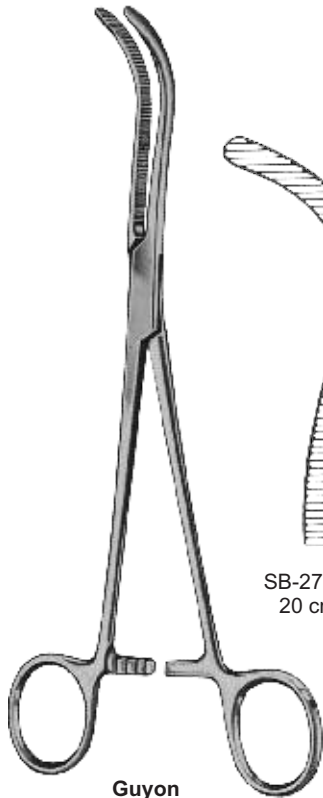

Guyon

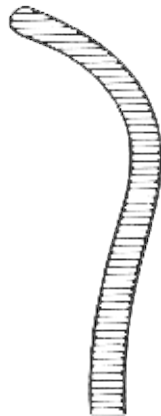

SB-2777-20
20 cm/8"

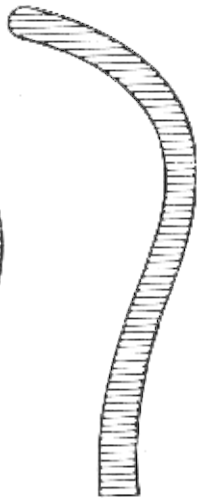

SB-2777-22
22 cm/8¾"

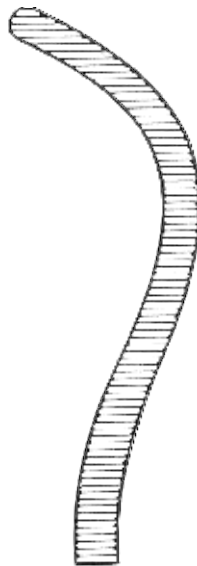

SB-2777-24
24 cm/9½"



SB-2778-23
23 cm/9"



SB-2779-24
24 cm/9½"

Kidney, Liver and Gall Stone Instruments

Kidney Pedicle Clamps Forceps
Kidney Gestielte Klemmen Pinzetten

Rein pédiculaires Forceps Pincers
Pinzas Pinzas renales pediculares

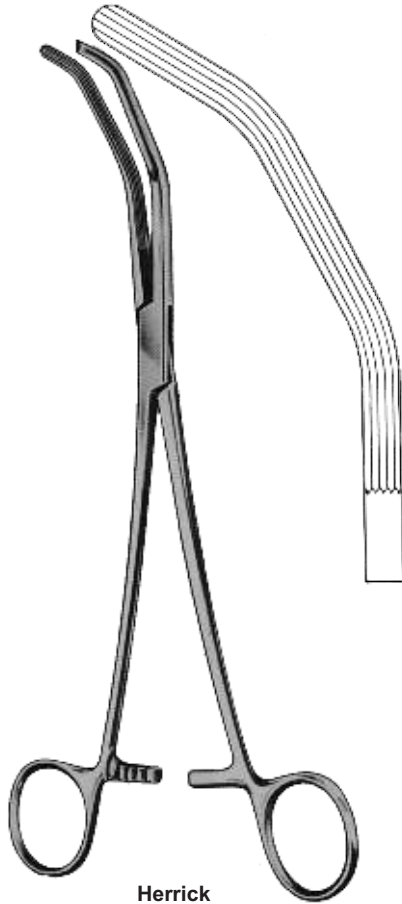

Herrick
SB-2780-23
23 cm/9"

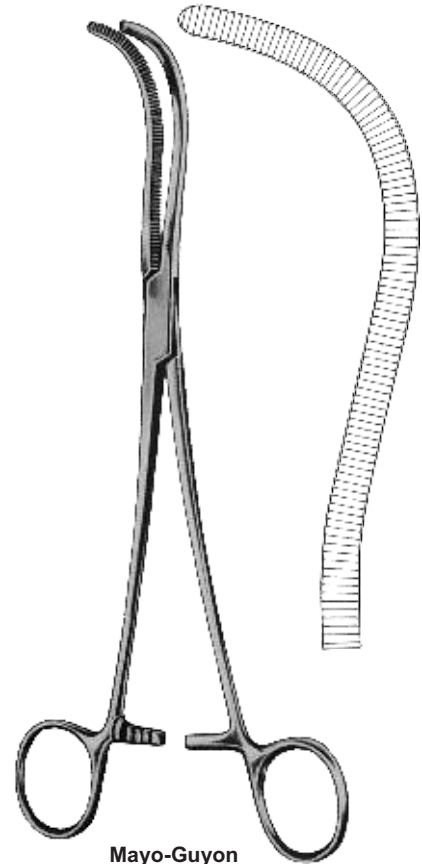

Mayo-Guyon
SB-2781-23
23 cm/9"

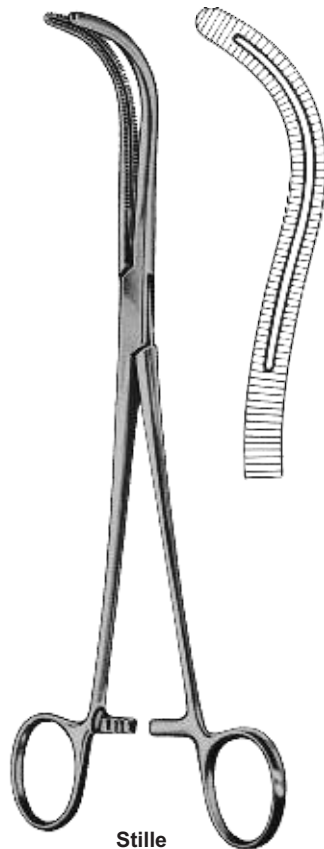

Stille
SB-2782-23
23 cm/9"

Kidney, Liver and Gall Stone Instruments

Kidney Stone Forceps
Nierensteinzangen

Pince de calculs rénaux
Pinzas de cálculos renales

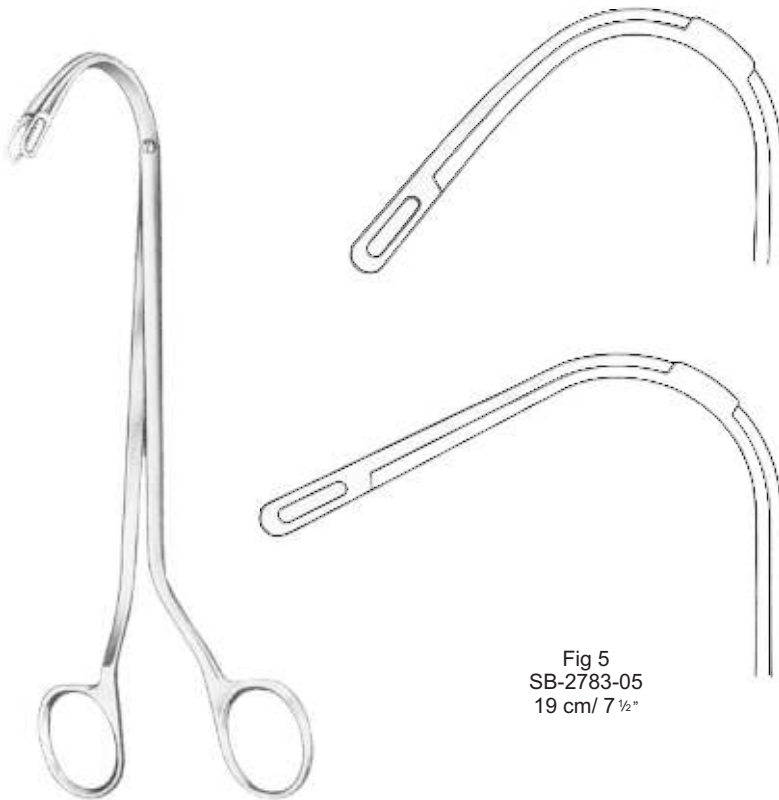

Fig 5
SB-2783-05
19 cm / 7 1/2"

Randall

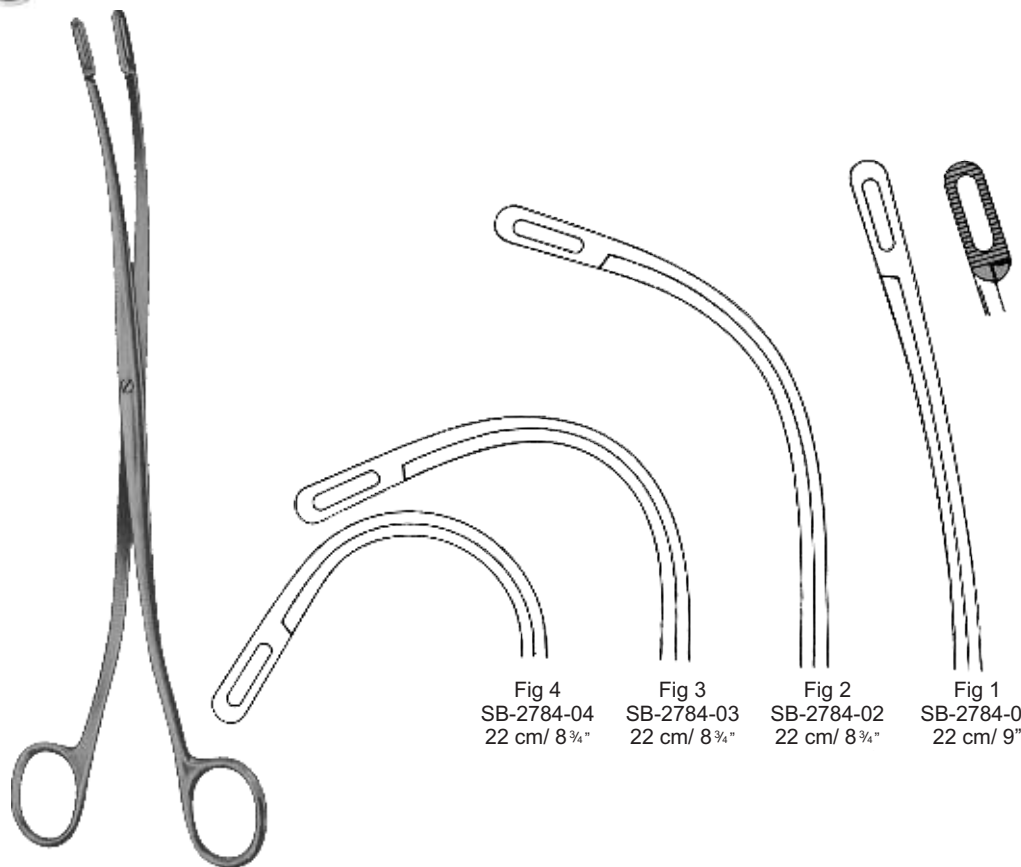

Fig 4
SB-2784-04
22 cm / 8 3/4"

Fig 3
SB-2784-03
22 cm / 8 3/4"

Fig 2
SB-2784-02
22 cm / 8 3/4"

Fig 1
SB-2784-01
22 cm / 9"

Randall

Kidney, Liver and Gall Stone Instruments

Gall Duct Forceps

Gallenwegefunktionsstörungen Zange

Pince conduits biliaires

Pinzas de conductos biliares



Gray

Fig. 1
SB-2785-01
22 cm/8¾"

Fig. 2
SB-2785-02
23 cm/9"



Gray

Fig. 1
SB-2786-01
22 cm/8¾"

Fig. 2
SB-2786-02
23 cm/9"

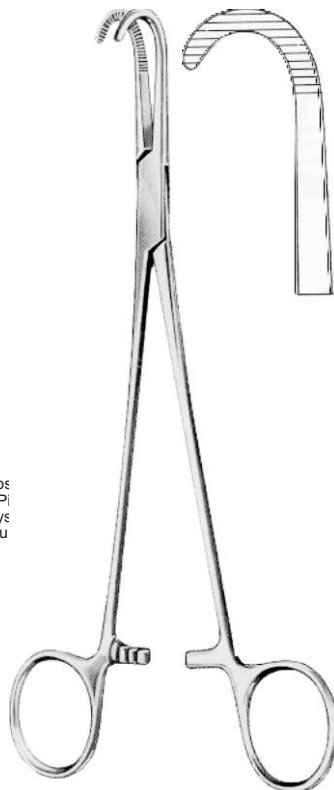

Gall duct and cystic forceps
Gall Kanal und zystische Pi
Conduit biliaire et pince kys
Gall conducto y fórceps qu

Desjardins
SB-2787-21
21 cm/8¼"

Nissen
SB-2788-21
21.5 cm/8½"

Kidney, Liver and Gall Stone Instruments

Gall Stone Forceps
Gallenstein Zange

Pince lithiase vésiculaire
Pinzas de cálculos biliares



Blake
SB-2789-20 20 cm/8" SB-2790-20
Straight gerade droit recto
Curved Gebogene courbé Curvo



Mayo-Blake
SB-2791-20 20 cm/8" SB-2792-20
Straight gerade droit recto
Curved Gebogene courbé Curvo



Czerny
SB-2793-24
24.5 cm/9¾"



Desjardins
23 cm/9"

Kidney, Liver and Gall Stone Instruments

Gall Stone Probes and Bile Duct Dilators

Gallenstein-Sonden und Gallengang Dilatatoren

Sondes lithiase vésiculaire et Dilatateurs des canaux biliaires

Sondas de cálculos en la vesícula y los dilatadores de los Conductos Biliares

Elastic



Desjardins
28 cm/11"

SB-2796-01



SB-2796-02



SB-2796-03



Bile duct dilators.



Bakes
30 cm/12"

mm

1	SB-2797-01
2	SB-2797-02
3	SB-2797-03
4	SB-2797-04
5	SB-2797-05
6	SB-2797-06
7	SB-2797-07
8	SB-2797-08
9	SB-2797-09
10	SB-2797-10
11	SB-2797-11
12	SB-2797-12
13	SB-2797-13

SB-2797-00

Set of 9 pieces
Satz von 9 Stück
ensemble de 9 pièces
juego de 9 piezas

SB-2797-03 to SB-2797-11

SB-2798-00

Set of 9 pieces in canvas pocket
Satz von 9 Stück in der Leinwand Tasche
ensemble de 9 pièces dans la poche de toile
conjunto de 9 piezas en bolsa de lona

Kidney, Liver and Gall Stone Instruments

Gall Stone Scoops
Gallenstein Scoops

Gall Pierre Scoops
Gall Stone Scoops

Elastic



Desjardins
30 cm/12"



Fig.1
SB-2799-01



Fig.2
SB-2799-02



Fig.3
SB-2799-03



Fig.4
SB-2799-04

Malleable
formbar
malléable
maleable



Luer-Koerte
32 cm/12½"



SB-2800-02
2.5 mm



SB-2800-03
3.2 mm



SB-2800-04
4.2 mm



SB-2800-05
5.5 mm



SB-2800-06
6.7 mm



SB-2800-08
8.0 mm



SB-2800-11
11 mm



SB-2800-15
15 mm

Kidney, Liver and Gall Stone Instruments

Gall Stone Scoops
Gallenstein Scoops

Gall Pierre Scoops
Gall Stone Scoops

Malleable
formbar
malléable
maleable



Mayo
SB-2801-28
28 cm/11"



Mayo
26.5 cm/10½"



Fig. 1
SB-2802-01



Fig. 2
SB-2802-02



Fig. 3
SB-2802-03

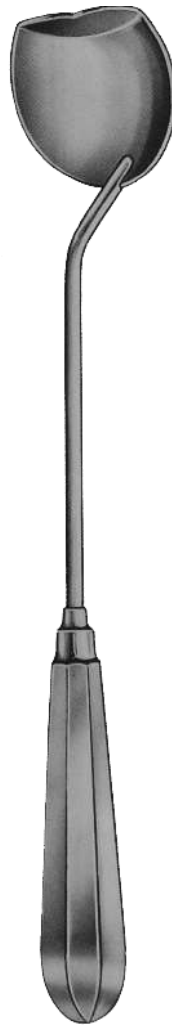

Moore
SB-2803-28
28 cm/11"

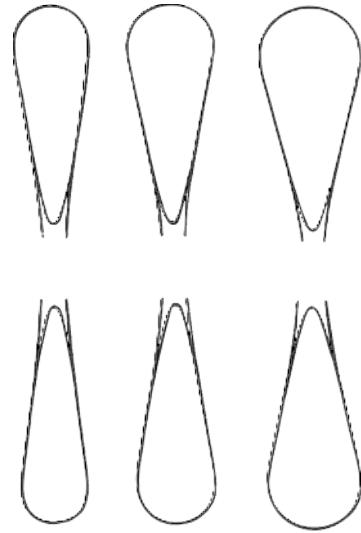
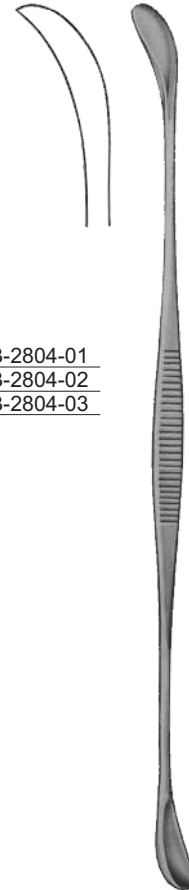

Fig.
1 SB-2804-01
2 SB-2804-02
3 SB-2804-03



Fergusson
24 cm/9½"

Bladder and Urology Instruments

Prostatic Retractors and Prostatic Lobe Holding Forceps
Prostata und Prostata-Reraktoren Lobe Haltezange

Rétracteurs prostatiques et de la prostate Davier à lobes
Los retractores de la Próstata y pinzas de sujeción del lóbulo de la Próstata



Young
SB-2805-21
21 cm/8¼"



Young
SB-2806-22
22 cm/8¾"



Young
SB-2807-21
21 cm/8¼"



Young
SB-2808-22
22 cm/8¾"



Millin
SB-2809-23
23 cm/9"



Millin
SB-2810-23
23 cm/9"



Millin
SB-2811-23
23 cm/9"

Bladder and Urology Instruments

Bladder Retractors
Blasen-Wundhaken

rétracteurs de la vessie
Los retractores de vejiga



Millin
SB-2812-28
28.5 cm/11 1/4"



Millin
SB-2813-00

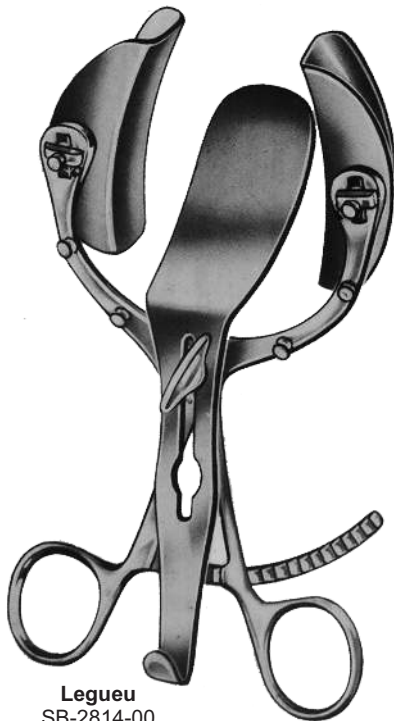

Legueu
SB-2814-00

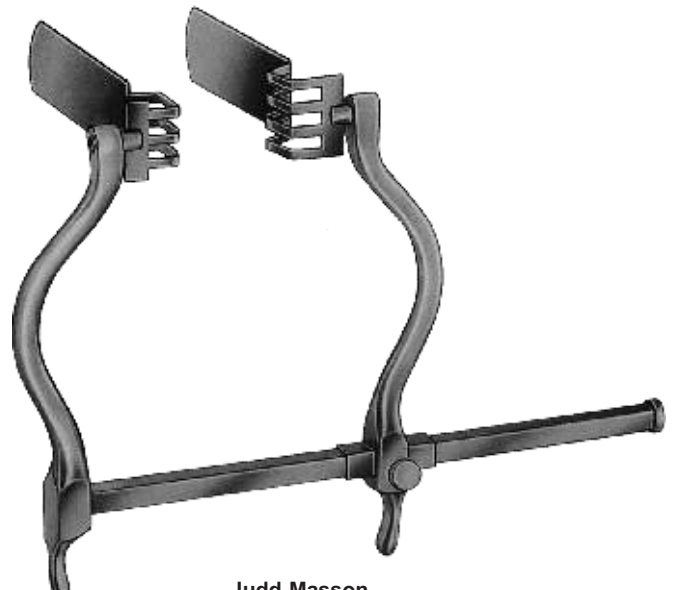

Judd-Masson
SB-2815-00

Bladder and Urology Instruments

Bladder Retractors
Blasen-Wundhaken

rétracteurs de la vessie
Los retractoros de vejiga

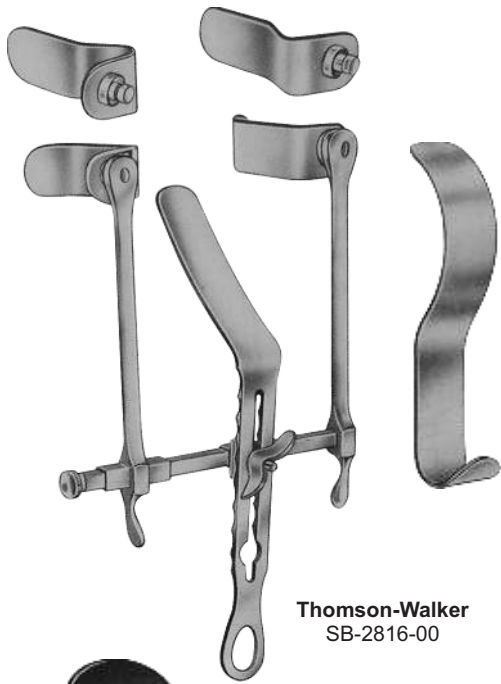

Thomson-Walker
SB-2816-00

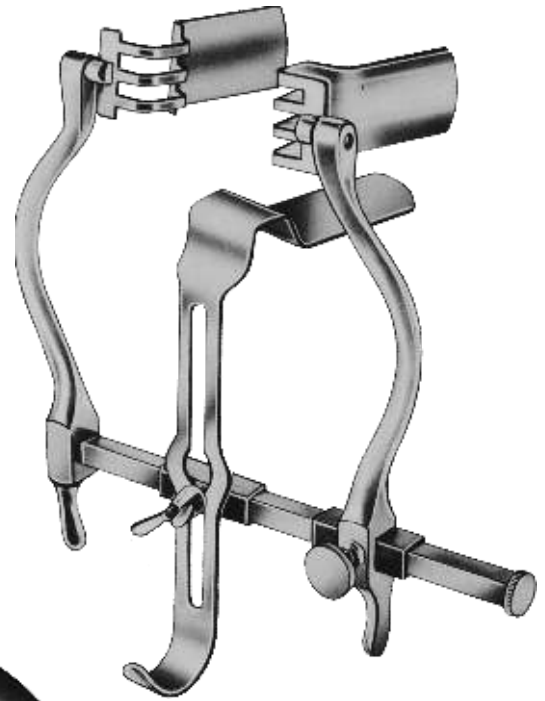

Judd-Masson
SB-2817-00



Legueu
SB-2818-27
27 cm/10½"
35 mm



Kocher
SB-2819-26
26 cm/10¼"
67 mm

Bladder and Urology Instruments

Dilating Bougies
Dehn-Bougies

Bougies de dilatation
bujías de dilatación

mm Ø	Charriere (French)
2 ² / ₃	8
3	9
3 ¹ / ₃	10
3 ² / ₃	11
4	12
4 ¹ / ₃	13
4 ² / ₃	14
5	15
5 ¹ / ₃	16
5 ² / ₃	17
6	18
6 ¹ / ₃	19
6 ² / ₃	20
7	21
7 ¹ / ₃	22
7 ² / ₃	23
8	24
8 ¹ / ₃	25
8 ² / ₃	26
9	27
9 ¹ / ₃	28
9 ² / ₃	29
10	30
10 ¹ / ₃	32
11 ² / ₃	34
12	36



Van Buren
Charrier (French)
No. 8-36
SB-2820-08
SB-2820-36
28 cm/11"
In Canvas Pouch
SB-2820-50
Set of 6
6 Pcs. SB-2820-14/24

SB-2820-60
Set of 12
12 Pcs SB-2820-08/30

SB-2820-08
SB-2820-10
SB-2820-12
SB-2820-14
SB-2820-16
SB-2820-18
SB-2820-20
SB-2820-22
SB-2820-24
SB-2820-26
SB-2820-28
SB-2820-30
SB-2820-32
SB-2820-34
SB-2820-36



Dittel
Charriere (French)
No. 8-30
SB-2821-08
SB-2821-30
19.5 cm/7 1/2"

Straight gerade droit recto
SB-2821-08
SB-2821-09
SB-2821-10
SB-2821-11
SB-2821-12
SB-2821-13
SB-2821-14
SB-2821-15
SB-2821-16
SB-2821-17
SB-2821-18
SB-2821-19
SB-2821-20
SB-2821-21
SB-2821-22
SB-2821-23
SB-2821-24
SB-2821-25
SB-2821-26
SB-2821-27
SB-2821-28
SB-2821-26
SB-2821-30



Dittel
Charriere (French)
No. 8-30
SB-2822-08
SB-2822-30
34.5 cm/13 1/2"

Curved Gebogene courbé Curvo
SB-2822-08
SB-2822-09
SB-2822-10
SB-2822-11
SB-2822-12
SB-2822-13
SB-2822-14
SB-2822-15
SB-2822-16
SB-2822-17
SB-2822-18
SB-2822-19
SB-2822-20
SB-2822-21
SB-2822-22
SB-2822-23
SB-2822-24
SB-2822-25
SB-2822-26
SB-2822-27
SB-2822-28
SB-2822-26
SB-2822-30

Bladder and Urology Instruments

Metal Catheters and Introducers
Metall-Katheter und Tubuswechsler

Cathéters métalliques et introducteurs
Los catéteres de metal e introductores

For men

For Women



19-2623-06
19-2623-24

	mm Ø	Charriere (French)	
SB-2823-06	2	6	SB-2824-06
SB-2823-07	2 ¹ / ₃	7	SB-2824-07
SB-2823-08	2 ² / ₃	8	SB-2824-08
SB-2823-09	3	9	SB-2824-09
SB-2823-10	3 ¹ / ₃	10	SB-2824-10
SB-2823-11	3 ² / ₃	11	SB-2824-11
SB-2823-12	4	12	SB-2824-12
SB-2823-13	4 ¹ / ₃	13	SB-2824-13
SB-2823-14	4 ² / ₃	14	SB-2824-14
SB-2823-15	5	15	SB-2824-15
SB-2823-16	5 ¹ / ₃	16	SB-2824-16
SB-2823-17	5 ² / ₃	17	SB-2824-17
SB-2823-18	6	18	SB-2824-18
SB-2823-19	6 ¹ / ₃	19	SB-2824-19
SB-2823-20	6 ² / ₃	20	SB-2824-20
SB-2823-21	7	21	SB-2824-21
SB-2823-22	7 ¹ / ₃	22	SB-2824-22
SB-2823-23	7 ² / ₃	23	SB-2824-23
SB-2823-24	8	24	SB-2824-24



Catheter Introducing Instruments



Guyon
SB-2825-39
39 cm/15¹/₂"



Guyon
SB-2826-35
35 cm/13³/₄"

Bladder and Urology Instruments

Metal Catheters and Cannula
Metall-Katheter und Kanülen

Cathéters métalliques et la canule
Catéteres de metal y la cánula



Bozemann-Fritsch
SB-2827-08 8mm
SB-2827-10 10mm
SB-2827-12 12mm



Rotunda Hospital
SB-2828-05 8 eg 5mm
SB-2828-06 10 eg 6mm



Carton
SB-2829-05 5mm
30cm/12"



Drew Smythe
SB-2830-00



Hayes Provis
SB-2831-00



Spackmann
SB-2832-00
18 cm/7"



Provis Intra
SB-2833-00



Spackmann
SB-2834-00

Bladder and Urology Instruments

Urology Introducers
Urologie Tubuswechsler

urologie Introduceurs
Urología Introduceores

Circumcision Instruments

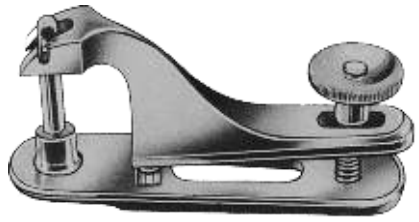

- SB-2835-08 08 mm
- SB-2835-11 11 mm
- SB-2835-13 13 mm
- SB-2835-16 16 mm
- SB-2835-21 21 mm
- SB-2835-26 26 mm
- SB-2835-32 32 mm

Foreign Body Forceps



Mathieu
SB-2836-28
28 cm/11"

Penis Clamps

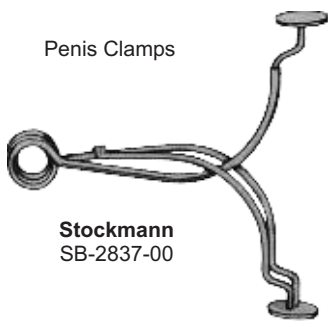

Stockmann
SB-2837-00



Strauss
SB-2838-00

Secretion Scoop



Guttman
SB-2839-26
26.5 cm/10½"



Serving Health Care

SPEED BIRD

ENTERPRISES



**161/C, SMALL INDUSTRIAL ESTATE
SIALKOT-51310, (PAKISTAN)**



: +92-304 0549944



: +92-52-3555584



: speed@birddent.com



: www.birddent.com