



SPEED BIRD
ENTERPRISES

www.birddent.com

**STOMACH, INTESTINE
AND RECTUM INSTRUMENTS**

SECTION

18

Stomach, Intestine and Rectum Instruments

Tissue Seizing Forceps and Intestinal
Atrauma Tissue Forceps

Saisir les tissus intestinaux et Pince Forceps tissu atraumatique
Aprovechando los tejidos Pinzas Pinzas intestinales y
tisulares Atrauma

Tissue ergriff Pinzetten und Darm Atrauma Pinzette

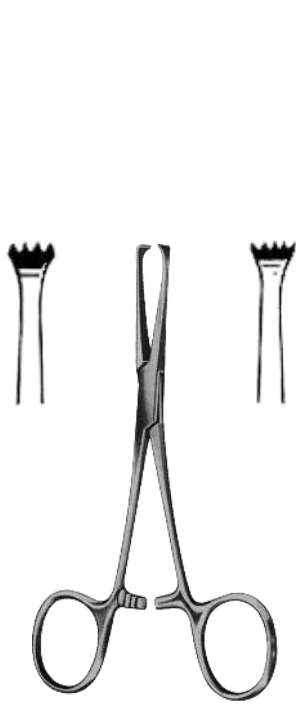

Baby-Allis

SB-2772-12 12 cm/4¾"
SB-2772-14 14 cm/5½"



Allis

| | | | |
|----|-----|------------|------------|
| cm | in | 4 : 5 | 5 : 6 |
| 15 | 6" | SB-2773-15 | SB-2774-15 |
| 19 | 7½" | | SB-2775-19 |
| 25 | 10" | | SB-2775-25 |

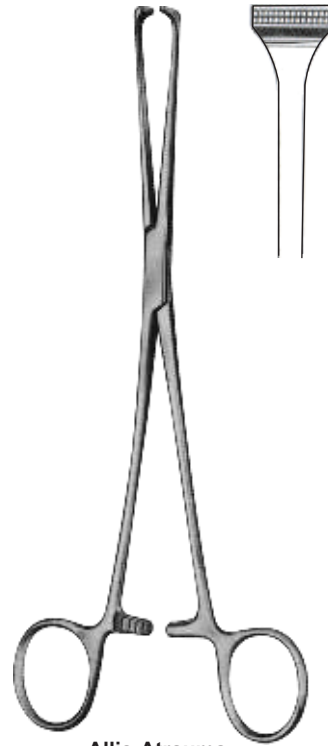

Allis-Atrauma

| | |
|------------|-----------|
| SB-2775-16 | 16 cm/6¼" |
| SB-2775-20 | 20 cm/8" |
| SB-2775-25 | 25 cm/10" |
| SB-2775-30 | 30 cm/12" |



Allis-Adair
SB-2776-15
15 cm/6"

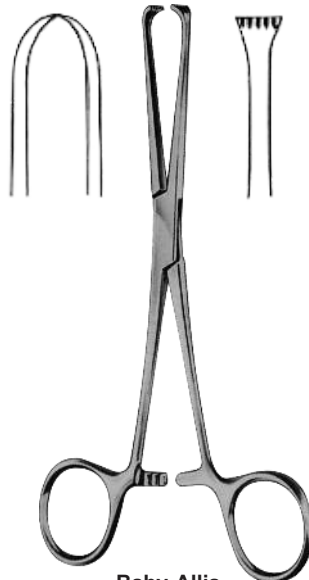

Baby-Allis
SB-2777-15
15 cm/6"



Lockwood-Allis
SB-2778-16 16 cm/6¼"
SB-2777-20 20 cm/8"

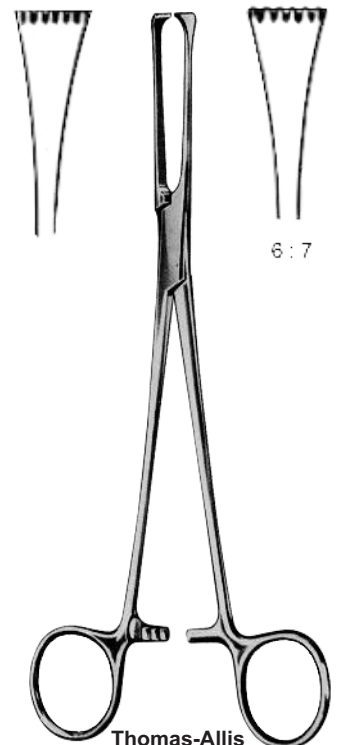

Thomas-Allis
SB-2779-20
20 cm/8"

Stomach, Intestine and Rectum Instruments

Intestinal Tissue Forceps, Atrauma, and Tungsten Carbide Inserts

Intestinale Pinzette, Atrauma, und Hartmetalleinlagen

Pince tissu intestinal, atraumatique, et de carbure de tungstène

Pinzas intestinales y tisulares Atrauma, y los rellenos de carburo de tungsteno

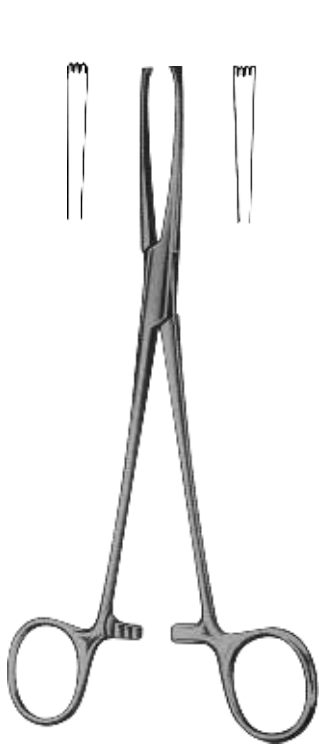

Judd-Allis
SB-2780-15 15 cm/6"
SB-2780-19 19 cm/7½"

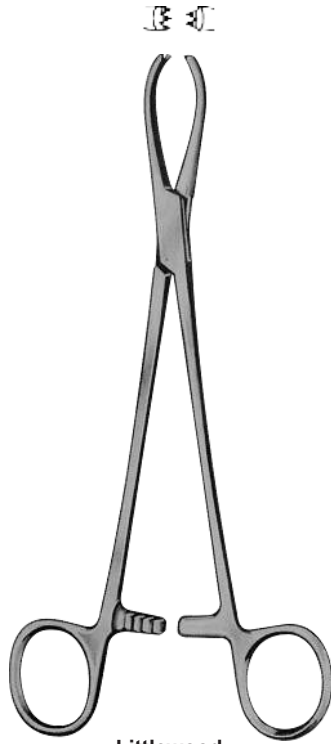

Littlewood
SB-2781-18
18.5 cm/7¼"



Williams
SB-2782-16
16 cm/6¼"



Lockwood
SB-2783-20
20 cm/8"



cm/in **Babcock-Atrauma**
16 cm/6¼" SB-2784-16
18 cm/7" SB-2784-20
20 cm/8" SB-2784-20
24 cm/9½" SB-2784-20



Babcock(Standard)
SB-2785-16
SB-2785-18
SB-2785-20
SB-2785-24

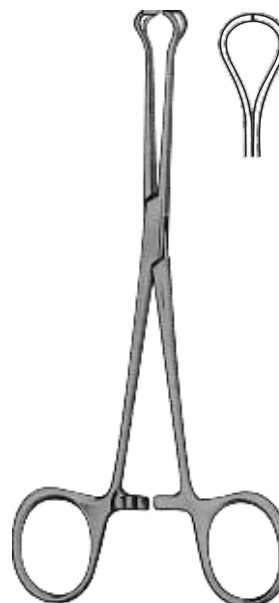

Baby-Babcock
SB-2786-16



Babcock
SB-2787-16
SB-2787-20

Stomach, Intestine and Rectum Instruments

Intestinal Tissue and Organ Grasping Forceps
Darmgewebe und Organ Grasing Zange

Tissu intestinal et Pince Grasping organes
Pinzas de tejido intestinal y órganos Grasing



SB-2788-18
18 cm/7"



SB-2788-20
20 cm/8"



SB-2788-23
23 cm/9"



Duval

| | cm | in | |
|------------|----|----|------------|
| SB-2789-18 | 18 | 7" | |
| SB-2789-20 | 20 | 8" | SB-2790-20 |
| SB-2789-23 | 23 | 9" | SB-2790-23 |



Duval
SB-2791-20
20 cm/8"

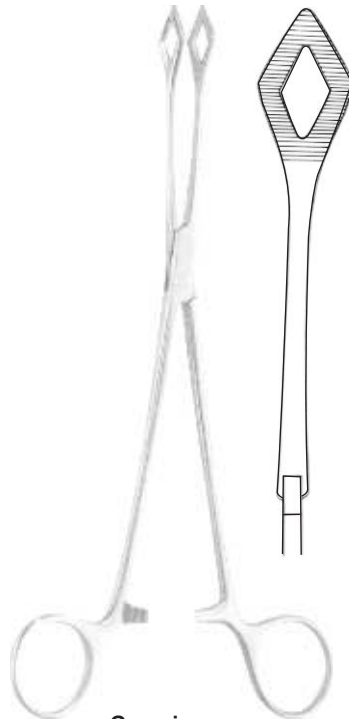

Gregoire

| | |
|------------|--------------|
| SB-2792-16 | 16 cm/6 1/4" |
| SB-2792-18 | 18 cm/7" |
| SB-2792-20 | 20 cm/8" |
| SB-2792-22 | 22 cm/8 3/4" |



SB-2793-25
24 cm/10"

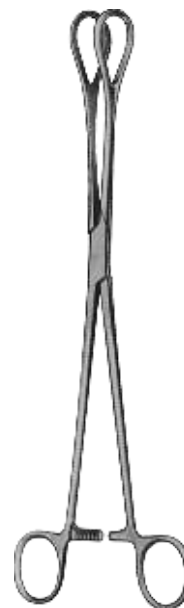

Coeur



SB-2793-26
26 cm/10 1/4"

Stomach, Intestine and Rectum Instruments

Intestinal Clamps Forceps
Darmklammern Zange

Intestinaux Forceps Pincés
Pinzas Pinzas intestinales

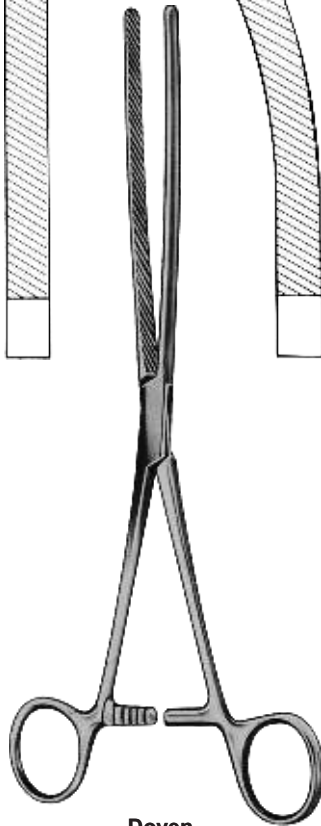
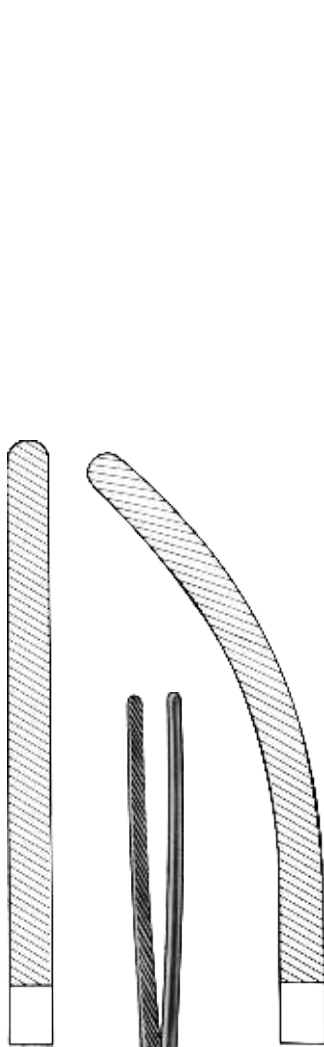

Doyen

SB-2796-21 21 cm/8 1/4"
SB-2796-23 23 cm/9"

Straight
gerade
droit
recto

SB-2797-21 21 cm/8 1/4"
SB-2797-23 23 cm/9"

Curved
Gebogene
courbe
Curvo

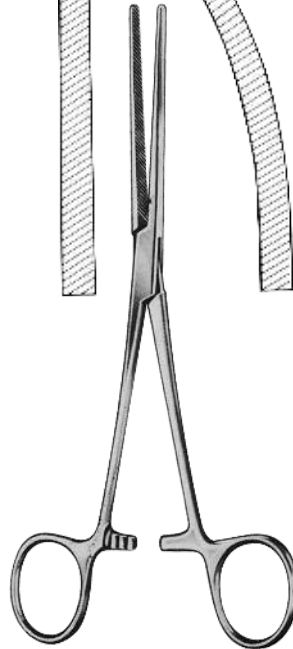
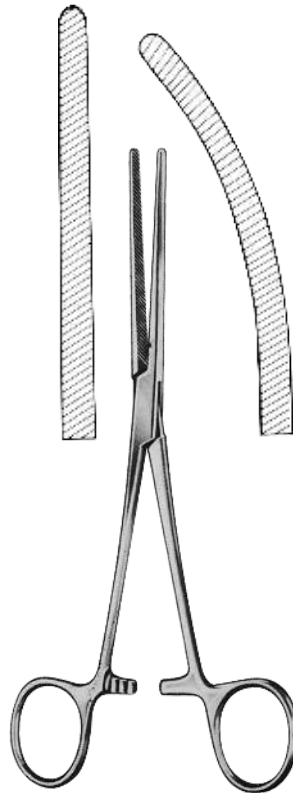

Baby-Doyen

SB-2794-18
18 cm/7"

Straight
gerade
droit
recto

SB-2795-18
18 cm/7"

Curved
Gebogene
courbe
Curvo

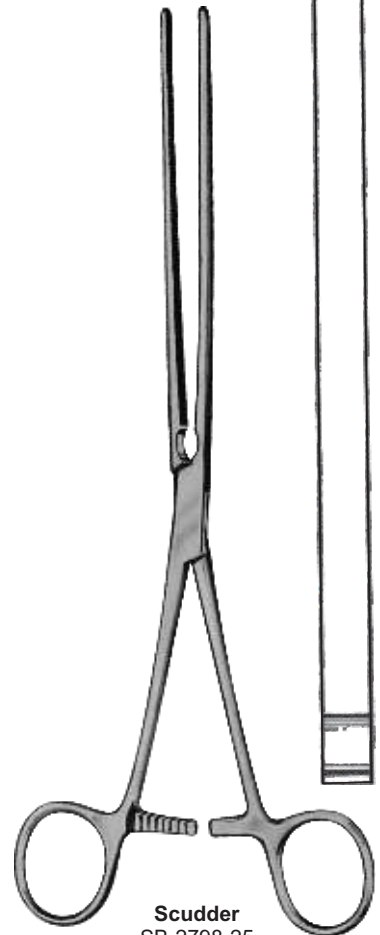
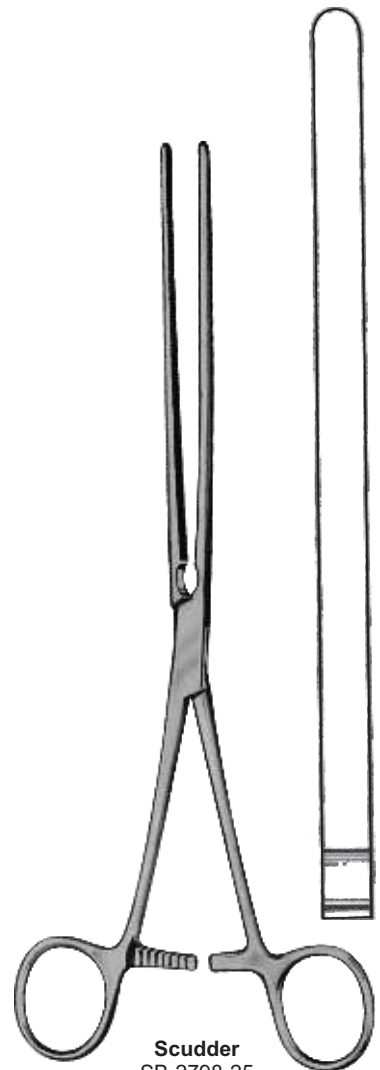

Scudder

SB-2798-25
25 cm/10"

Stomach, Intestine and Rectum Instruments

Atrauma Intestinal Clamps Forceps
Atrauma Darmklammern Zange

Atraumatique intestinaux Forceps Pinces
Atrauma Abrazaderas Pinzas intestinales



Doyen-Atrauma

Straight
gerade
droit
recto



SB-2799-13
13 cm/5"



SB-2799-16
16 cm/6 1/4"



SB-2799-18
18 cm/7"



SB-2799-21
21 cm/8 1/4"



SB-2799-23
23 cm/9"

Curved
Gebogene
courbe
Curvo



SB-2799A-13
13 cm/5"



SB-2799A-16
16 cm/6 1/4"



SB-2799A-18
18 cm/7"



SB-2799A-21
21 cm/8 1/4"

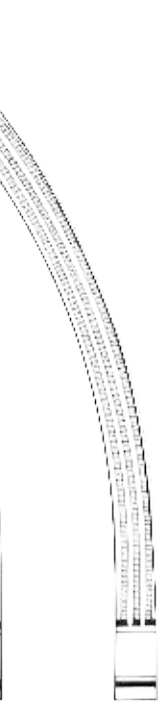

SB-2799A-23
23 cm/9"

Stomach, Intestine and Rectum Instruments

Intestinal Clamps Forceps
Darmklammern Zange

Intestinaux Forceps Pincers
Pinzas Pinzas intestinales



Mayo-Robson
Mayo-Robson Atrauma



SB-2800-21
21 cm/8 1/4"



SB-2801-21
21 cm/8 1/4"



SB-2802-23
23 cm/9"



SB-2803-23
23 cm/9"



SB-2804-25
25 cm/10"

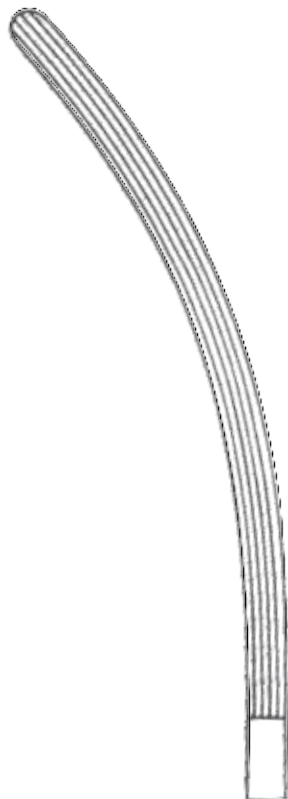

SB-2805-25
25 cm/10"



SB-2806-25
25 cm/10"



SB-2807-25
25 cm/10"

Stomach, Intestine and Rectum Instruments

Intestinal Clamps Forceps
Darmklammern Zange

Intestinaux Forceps Pince
Pinzas Pinzas intestinales

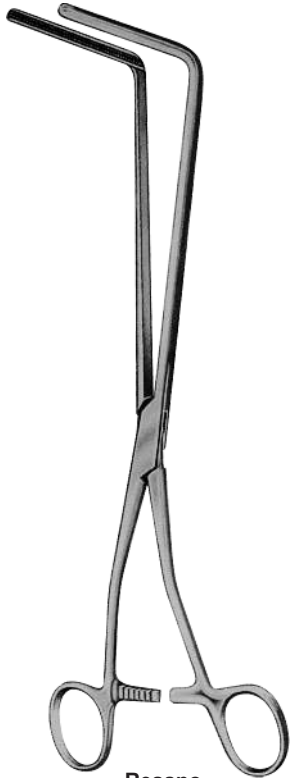

Resano
SB-2808-30
30 cm/12"



Hayes

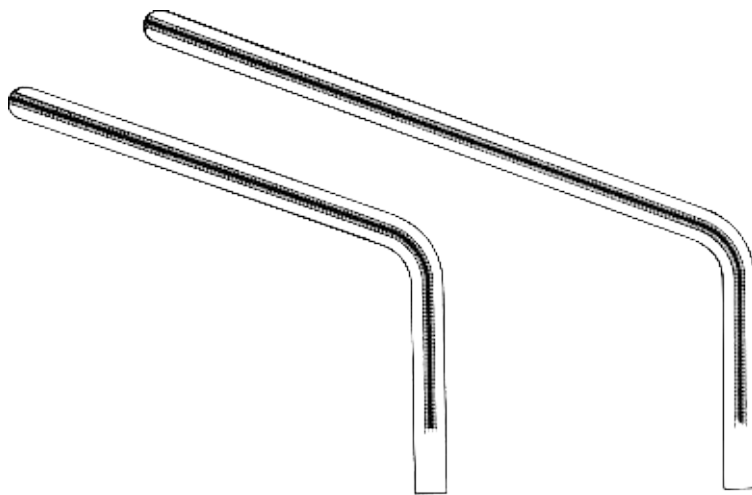

SB-2809-26
26 cm/10¼"

SB-2809-28
28 cm/11"

Stomach, Intestine and Rectum Instruments

Intestinal Clamps Forceps
Darmklammern Zange

Intestinaux Forceps Pincers
Pinzas Pinzas intestinales

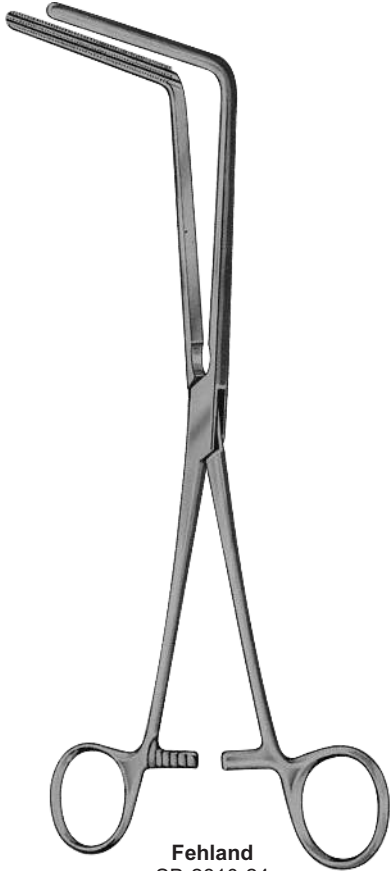

Fehland
SB-2810-24
24 cm/9½"



Brunner
24 cm/9½"

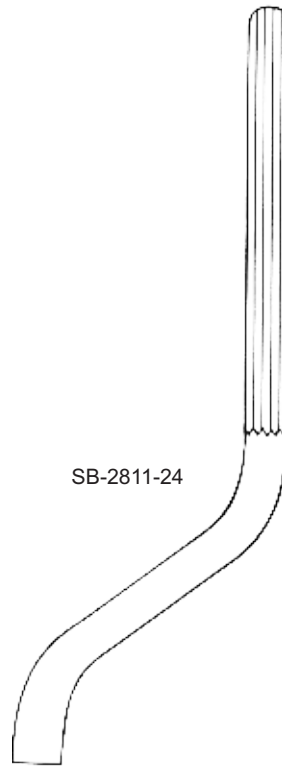

SB-2811-24

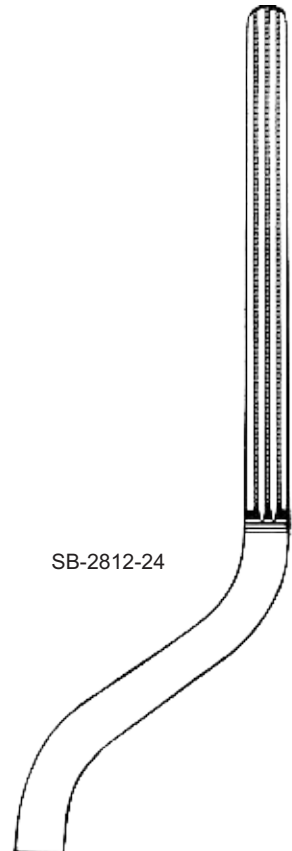

SB-2812-24

Stomach, Intestine and Rectum Instruments

Intestinal Clamps Forceps
Darmklammern Zange

Intestinaux Forceps Pincés
Pinzas Pinzas intestinales

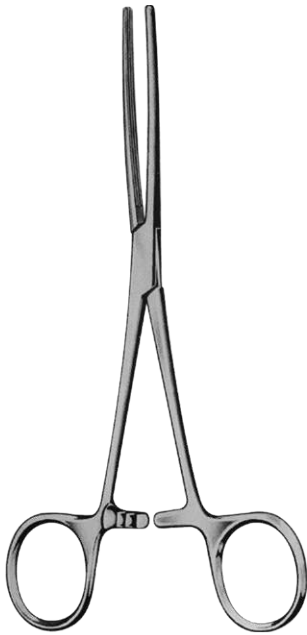

Baby-Kocher

SB-2813-05
13 cm/5"

Straight
gerade
droit
recto

SB-2813-05
13 cm/5"

Curved
Gebogene
courbé
Curvo



Kocher



SB-2815-01
22 cm/8¾"



SB-2815-02
25 cm/10"

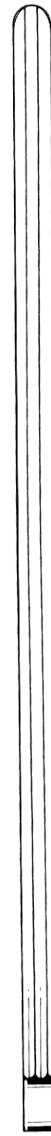

SB-2815-03
28 cm/11"

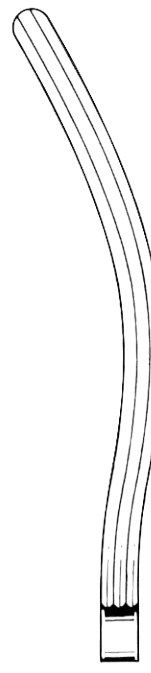

SB-2815-04
22 cm/8¾"

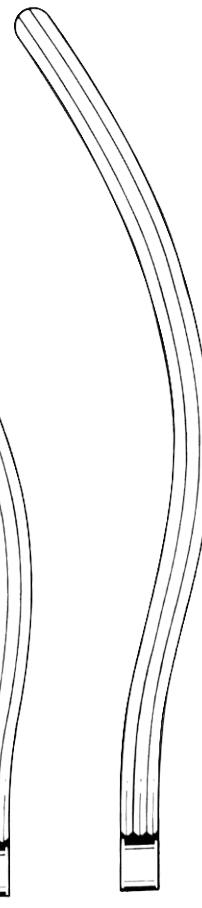

SB-2815-05
25 cm/10"

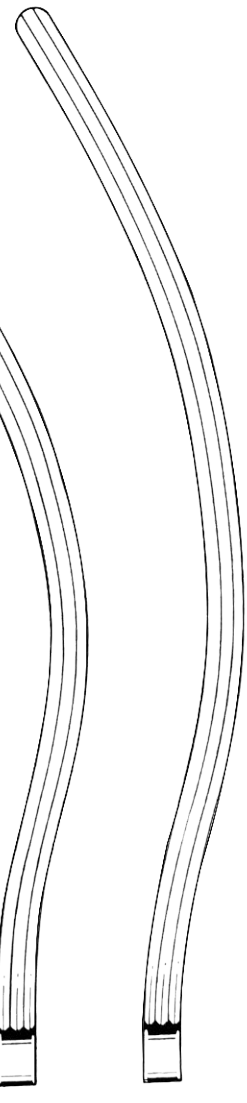

SB-2815-06
28 cm/11"

Stomach, Intestine and Rectum Instruments

Atrauma Intestinal Clamps Forceps
Atrauma Darmklammern Zange

Atraumatique intestinaux Forceps Pinces
Atrauma Abrazaderas Pinzas intestinales



Kocher-Atrauma

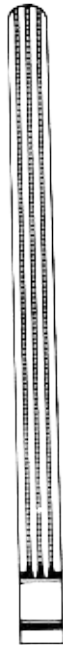

SB-2816-01
22 cm/8¾"



SB-2816-02
25 cm/10"

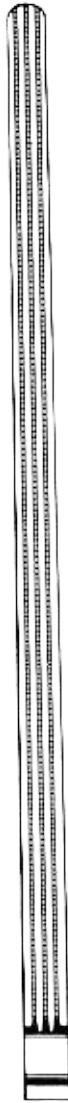

SB-2816-03
28 cm/11"



SB-2816-04
22 cm/8¾"



SB-2816-05
25 cm/10"

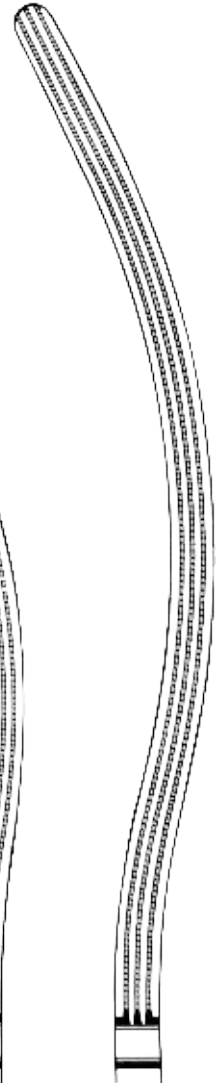

SB-2816-06
28 cm/11"

Stomach, Intestine and Rectum Instruments

Intestinal Clamps Forceps
Darmklammern Zange

Intestinaux Forceps Pincers
Pinzas Pinzas intestinales



SB-2817-25
Straight
gerade
droit
recto



Nussbaum
25 cm/10"

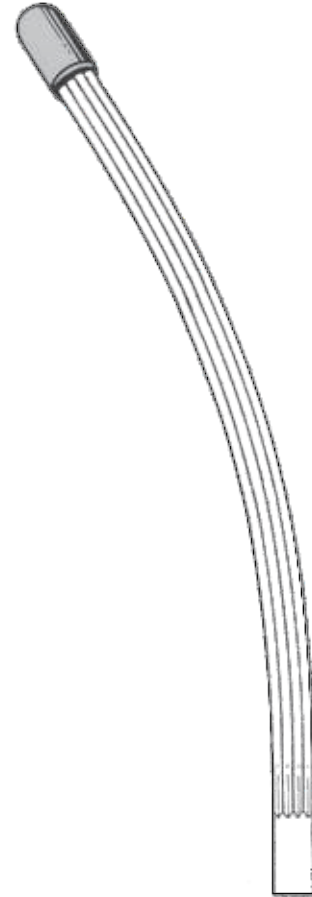

SB-2818-25
Curved
Gebogene
courbe
civière

Pylorus spreader

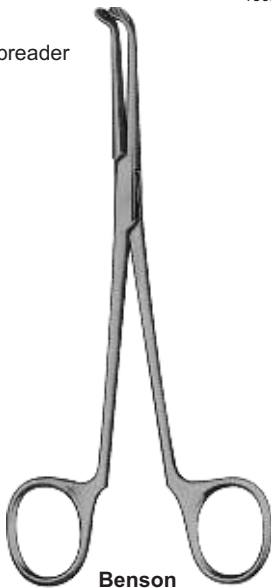

Benson
SB-2819-15
15.5 cm/6"

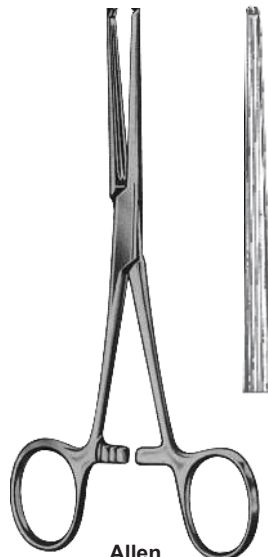

Allen
SB-2820-15 15.5 cm/6"
SB-2820-20 20.0 cm/8"

Blindgut forceps



Kleinschmidt
SB-2821-12
12 cm/4 3/4"

Stomach, Intestine and Rectum Instruments

Intestinal and Stomach Clamps Forceps
Magen-und Klemmen Pinzetten

Intestinaux et de l'Estomac Forceps Pincers
Intestinales y el estómago Pinzas Pinzas

Twin Clamps Forceps
Doppelschlauchklemmen Forceps
Pincers Pincers jumeaux
Pinzas Pinzas Gemelas

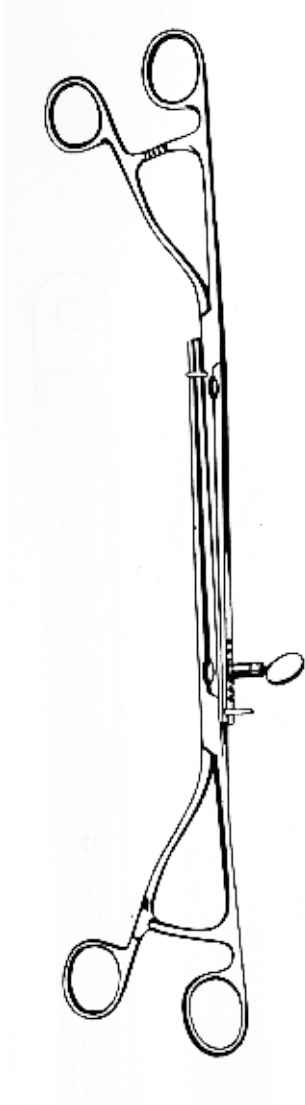

Lane
30 cm/12"



SB-2826-30
Straight
gerade
droit
recto

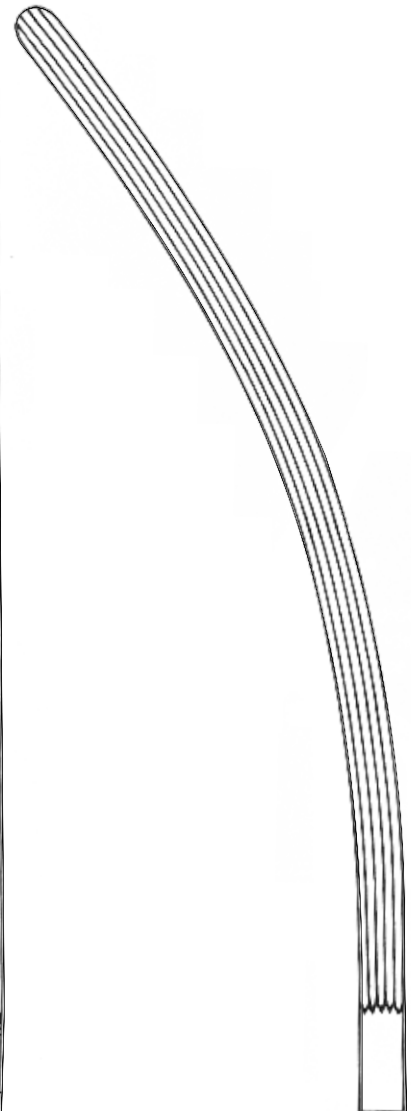

SB-2827-30
Curved
Gebogene
courbe
Curvo

Stomach, Intestine and Rectum Instruments

Intestinal Stomach Clamps
Darm-Magen-Schellen

Pinces estomac intestinaux
Abrazaderas intestinales estómago



Payr
(Payr-Baby)

For children
für Kinder
pour les enfants
Para los niños



SB-2828-15
15 cm/6"



SB-2829-21
21 cm/8¼"



SB-2830-29
29 cm/11½"



SB-2831-35
35 cm/13¾"

Stomach, Intestine and Rectum Instruments

Atrauma Intestinal Forceps
Atrauma Darmklemmen

Pince atraumatique intestinaux
Atrauma Pinzas intestinales

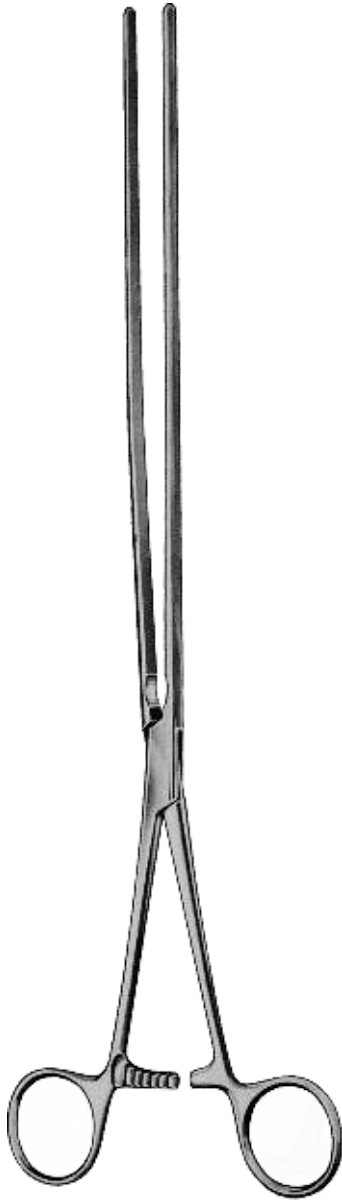

**Scudder
Scudder-Atraume**
33 cm/13"



SB-2832-33
Straight
gerade
droit
recto

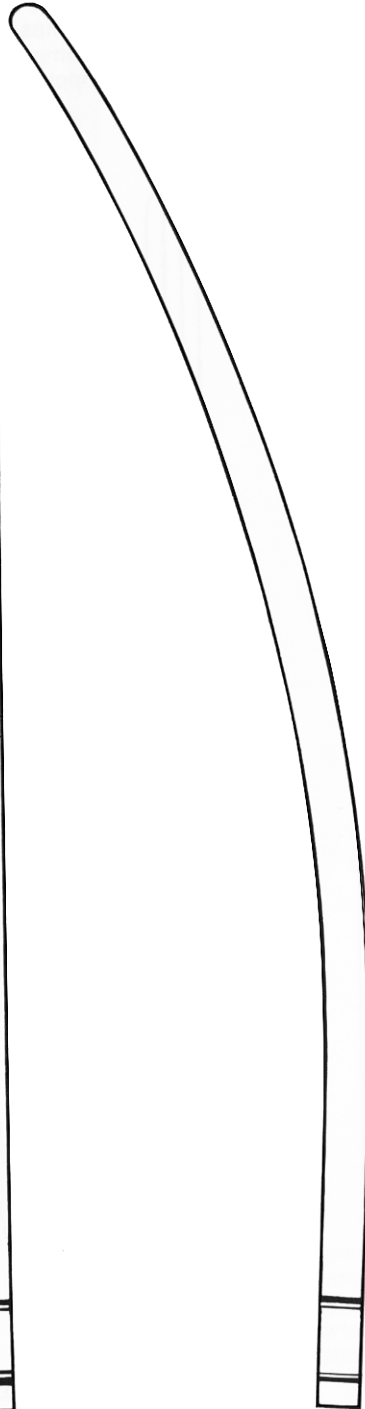

SB-2833-33
Curved
Gebogene
courbe
Curvo

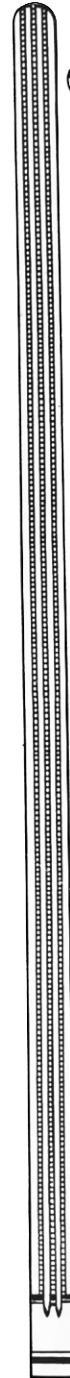

SB-2834-33
Straight
gerade
droit
recto

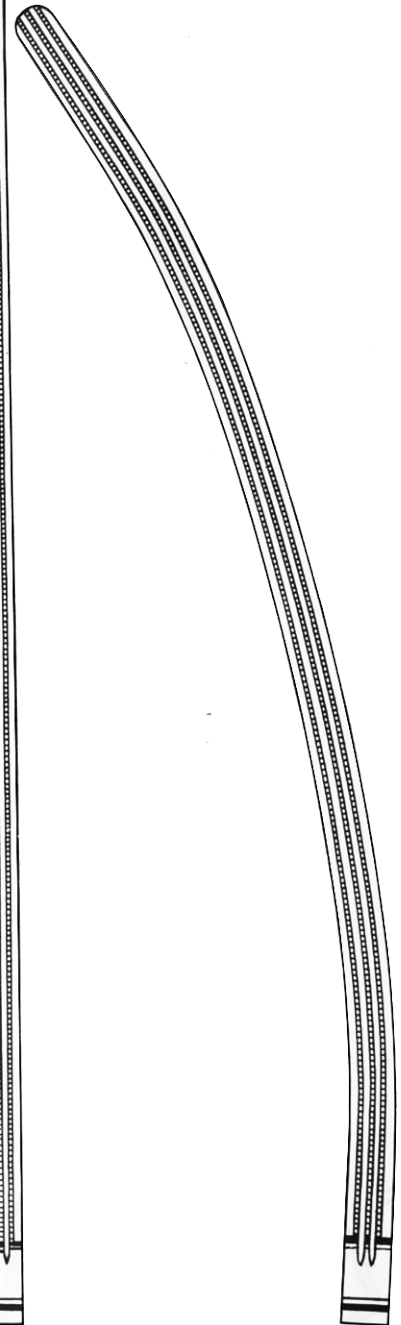

SB-2835-33
Curved
Gebogene
courbe
Curvo

Stomach, Intestine and Rectum Instruments

Stomach Clamp Forceps
Magen Klammerzange

Estomac Forceps Clamp
Estômago pinza fórceps

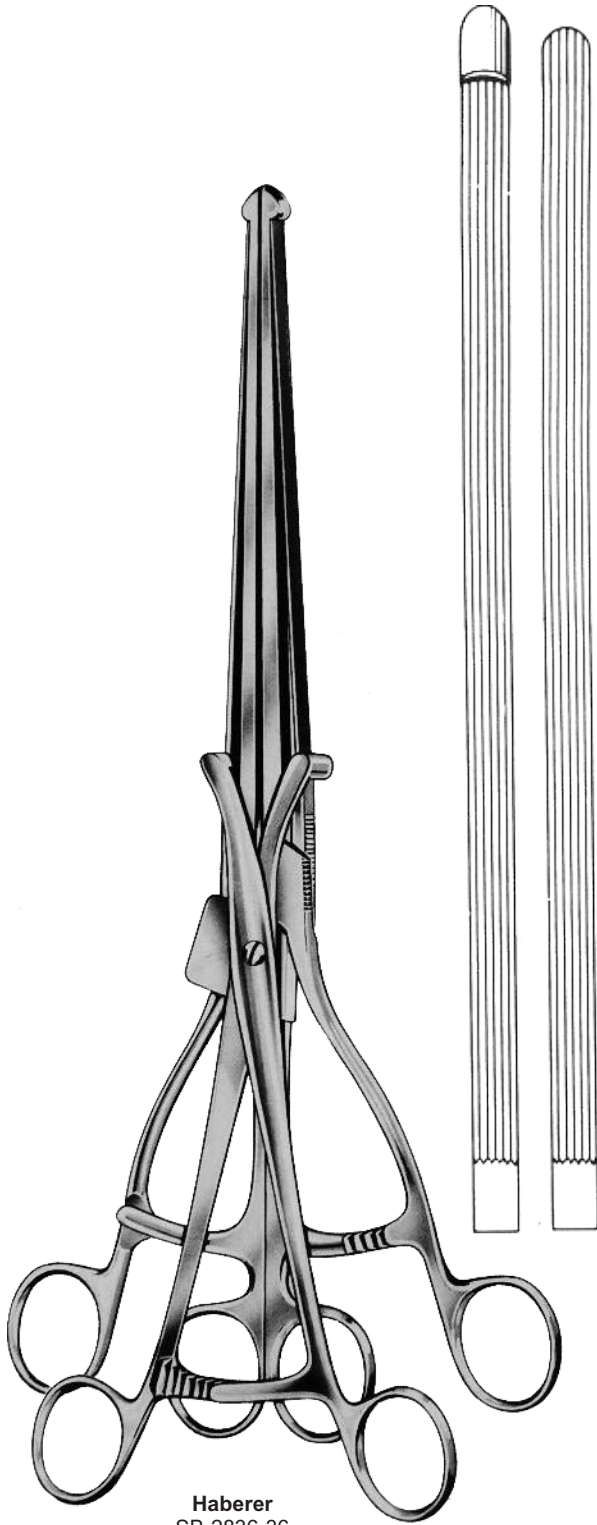

Haberer
SB-2836-36
36 cm/14"

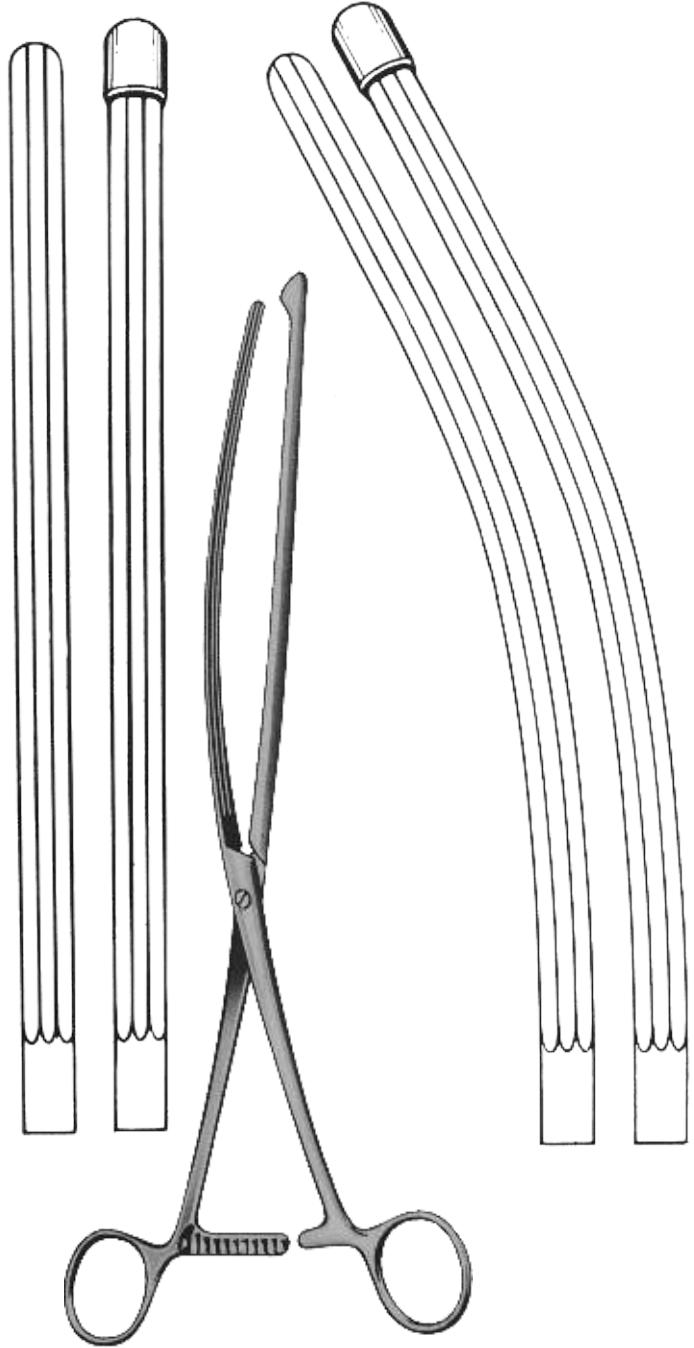

SB-2837-01
Straight
gerade
droit
recto

Nussbaum
30 cm/12"

SB-2837-02
Curved
Gebogene
courbe
Curvo

Intestine and Anastomosis

Clamps Forceps

Klemmen Pinzetten

Forceps Pincas

Pinzas Pinzas



De Martel-Wolfson
SB-2838-05 5cm/2"
SB-2838-07 7cm/2 3/4"
SB-2838-10 10cm/4"

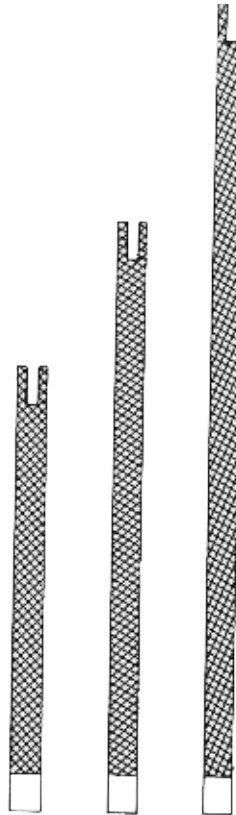

5 cm/2" 7 cm/2 3/4" 10 cm/4"

Set of 3 clamps
Set aus 3 Klemmen
Jeu de 3 pincas
Juego de 3 pinzas



De Martel-Wolfson
SB-2839-00
26 cm/19 3/4"



SB-2840-08
8,5 cm/1/2"



De Martel-Wolfson
SB-2841-23
23 cm/9"

Stomach, Intestine and Rectum Instruments

Rectal Speculas
Rektale Speculas

Speculas rectales
espéculos rectales

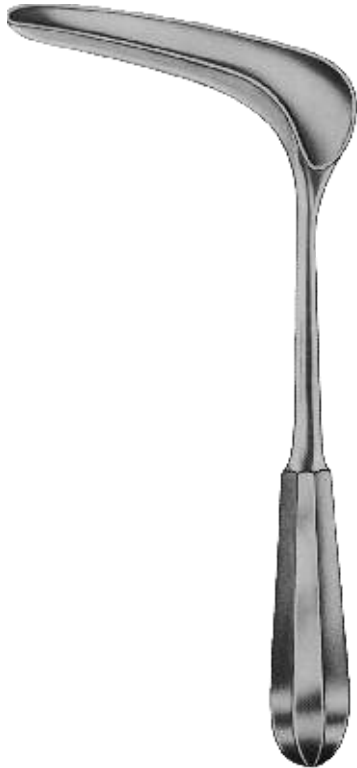

Czerny
SB-2842-22
22 cm/8¾"



Sims
18-2543-15

Sims
SB-2844-15
15 cm/6"

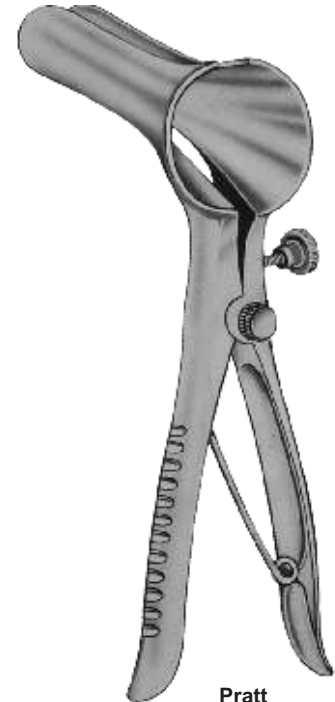

Pratt
SB-2845-20
80 x 25 mm
20.5 cm/8"



Mathieu
SB-2846-19
90 x 15 mm
19.5 cm/7¾"

Length of Blades
Länge der Klängen
Longueur des lames
Duración de Blades

| | |
|------------|--------|
| SB-2847-06 | 60 mm |
| SB-2847-08 | 80 mm |
| SB-2847-12 | 125 mm |
| SB-2847-15 | 150 mm |



Stomach, Intestine and Rectum Instruments

Rectal Speculas, Anal Retractors and Anusopes
Rektale Speculas, Anal Retraktoren und Anusopes

Speculas rectales, Rétracteurs Anal et Anusopes
Especulos rectales, Retractores Anal y Anusopes



Barr
SB-2848-17
17 cm/6¾"
70 X 22 mm



Anal Retractors
anal Retraktoren
écarteurs anaux
écarteurs anaux...

75 x 23 mm

Smith-Bule
SB-2849-15
15 cm/6"



Fig. 1 19 mm Ø x 70 mm
Fig. 2 22 mm Ø x 70 mm

Bensaude
SB-2850-01
SB-2850-02



Fig. 1 16 mm Ø x 65 mm
Fig. 2 19 mm Ø x 65 mm
Fig. 3 22 mm Ø x 65 mm
Fig. 4 25 mm Ø x 65 mm

Hirschmann
SB-2851-01
SB-2851-02
SB-2851-03
SB-2851-04

Stomach, Intestine and Rectum Instruments

Anusopes, Proctoscopes and Sphincteroscopes
Anusopes, Proktoskope und Sphincteroscopes

Anusopes, les proctoscopes et Sphincteroscopes
Anusopes y proctoscopios y Sphincteroscopes



Kelly

Fig. 1 21 mm Ø 50 mm SB-2852-01
Fig. 2 27 mm Ø 50 mm SB-2852-02

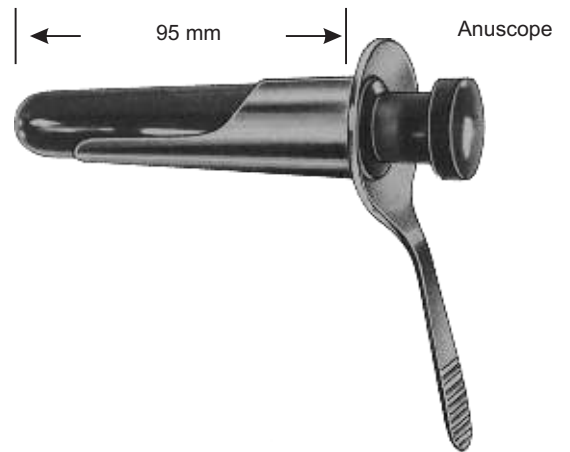

Ives-Fansler
SB-2853-22
22 mm Ø

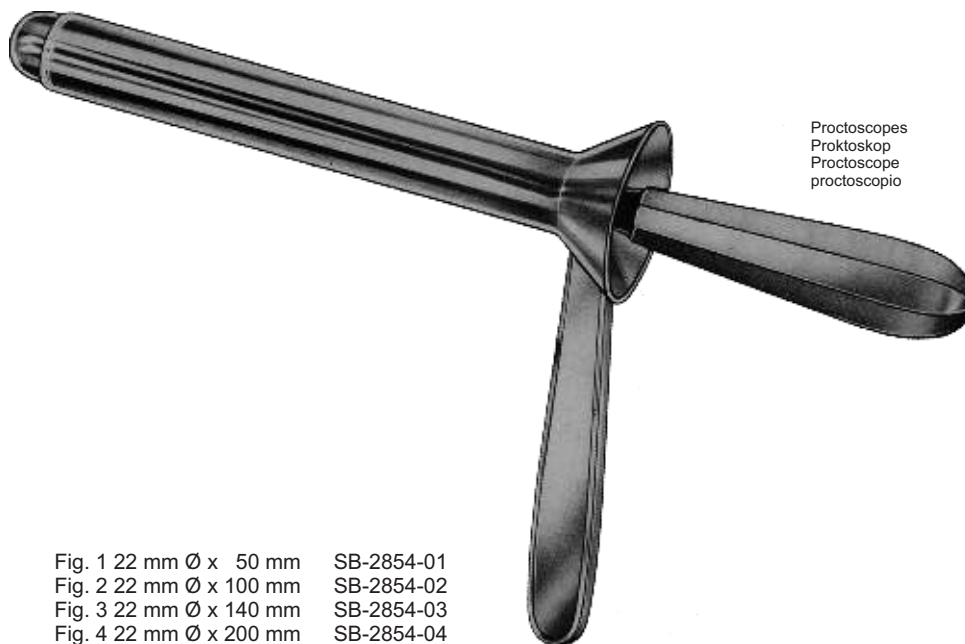

Proctoscopes
Proktoskop
Proctoscope
proctoscopio

Fig. 1 22 mm Ø x 50 mm SB-2854-01
Fig. 2 22 mm Ø x 100 mm SB-2854-02
Fig. 3 22 mm Ø x 140 mm SB-2854-03
Fig. 4 22 mm Ø x 200 mm SB-2854-04

Kelly

Stomach, Intestine and Rectum Instruments

Anal Retractors
Anal Retraktoren

Rétracteurs Anal
Retractoros Anal

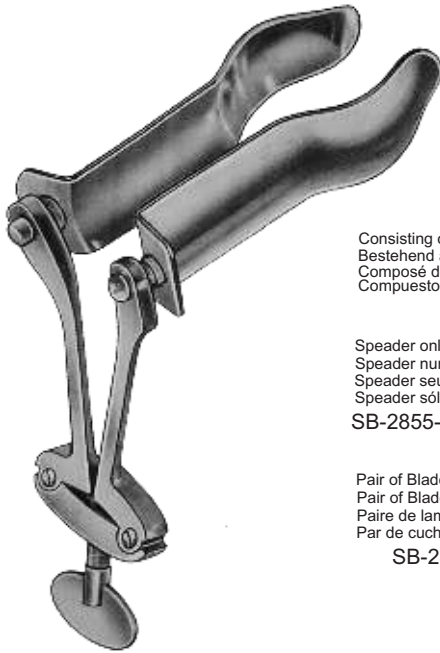

Consisting of:
Bestehend aus:
Composé de:
Compuesto por:

Spreader only
Spreader nur
Spreader seulement
Spreader sólo
SB-2855-01

Pair of Blades only 95 mm
Pair of Blades nur 95 mm
Paire de lames seulement 95 mm
Par de cuchillas sólo 95 mm
SB-2855-02

Park
SB-2855-00
13 cm/5"

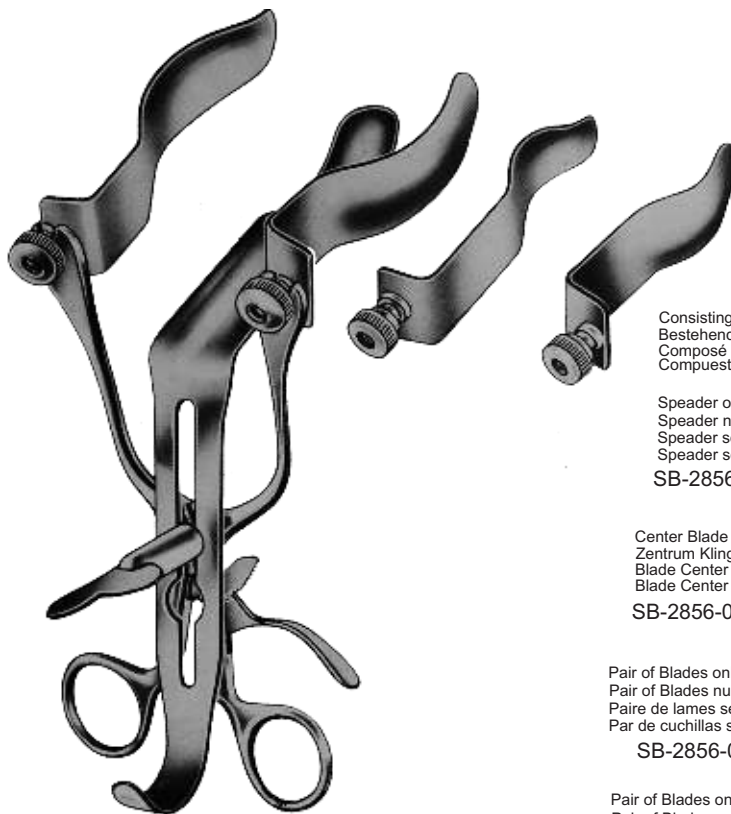

Consisting of:
Bestehend aus:
Composé de:
Compuesto por:

Spreader only
Spreader nur
Spreader seulement
Spreader sólo
SB-2856-01

Center Blade only
Zentrum Klinge nur
Blade Center ne
Blade Center sólo
SB-2856-02

Pair of Blades only 75 mm
Pair of Blades nur 75 mm
Paire de lames seulement 75 mm
Par de cuchillas sólo 75 mm
SB-2856-03

Pair of Blades only 95 mm
Pair of Blades nur 95 mm
Paire de lames seulement 95 mm
Par de cuchillas sólo 95 mm
SB-2856-04

Park
SB-2856-00
14.5 cm/5¾"

Stomach, Intestine and Rectum Instruments

Rectal Biopsy Specimen Forceps
Rektale Biopsie Zange

Pince biopsie rectale
Pinzas de biopsia rectal de muestras

Length of Shaft
Länge der Welle
Longueur de l'arbre
Longitud del eje

Turnable
drehbare
Tournant
turnable

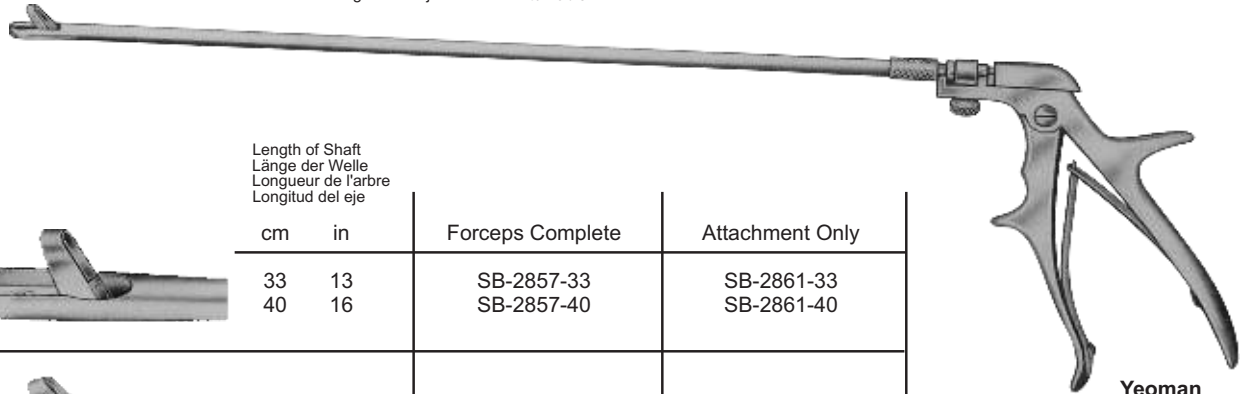

Yeoman (Turrell)
Handle Only
Handle nur
Manipulez uniquement
Manipular sólo
SB-2861-00

| | Length of Shaft Länge der Welle Longueur de l'arbre Longitud del eje | | Forceps Complete | Attachment Only |
|--|---|----|------------------|-----------------|
| | cm | in | | |
| | 33 | 13 | SB-2857-33 | SB-2861-33 |
| | 40 | 16 | SB-2857-40 | SB-2861-40 |
| | 33 | 13 | SB-2858-33 | SB-2862-33 |
| | 40 | 16 | SB-2858-40 | SB-2862-40 |
| | 33 | 13 | SB-2859-33 | SB-2863-33 |
| | 40 | 16 | SB-2859-40 | SB-2863-40 |
| | 33 | 13 | SB-2860-33 | SB-2864-33 |
| | 40 | 16 | SB-2860-40 | SB-2864-40 |

Length of Shaft
Länge der Welle
Longueur de l'arbre
Longitud del eje

Turnable
drehbare
Tournant
turnable

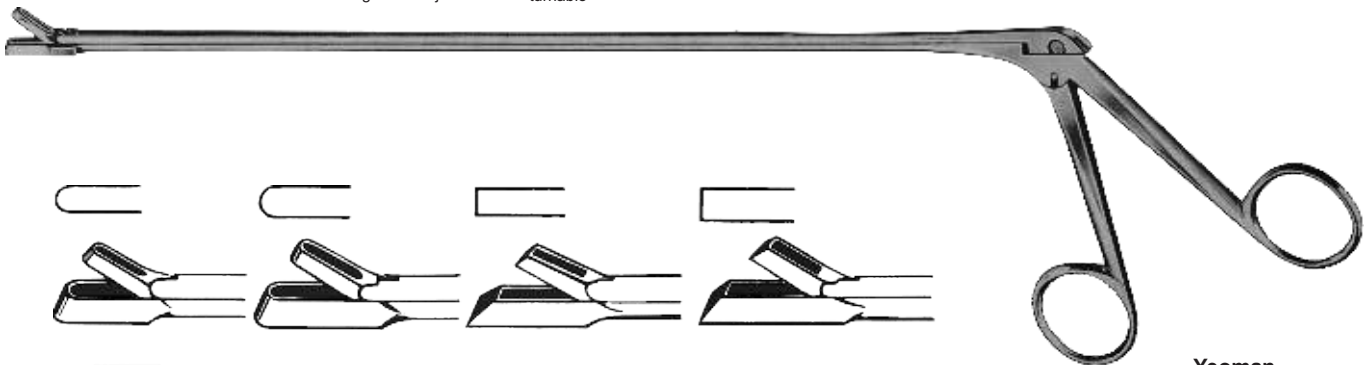

Yeoman

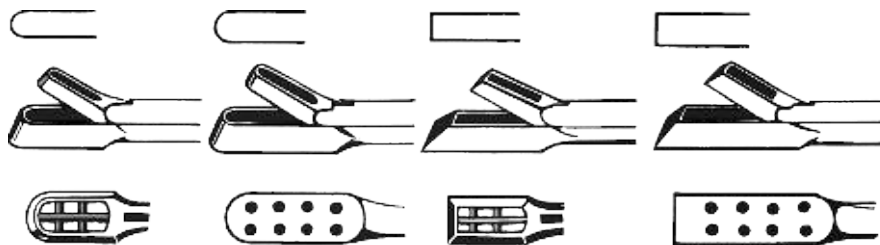

| A | B | C | D |
|------------|------------|------------|------------|
| SB-2865-28 | SB-2865-28 | SB-2865-28 | SB-2865-28 |
| SB-2865-35 | SB-2865-35 | SB-2865-35 | SB-2865-35 |
| SB-2865-42 | SB-2865-42 | SB-2865-42 | SB-2865-42 |

| cm | in |
|----|------|
| 28 | 11 |
| 35 | 13¾" |
| 42 | 16½" |

Stomach, Intestine and Rectum Instruments

Haemorrhoidal Forceps and Rectal Snares
Haemorrhoidal Pinzetten und Rectal Snares

Pince Haemorrhoidal et Snares rectales
Pinzas Haemorrhoidal y trampas rectales

Rectal Snare
rektale Snare
rectale piège
rectal trampa

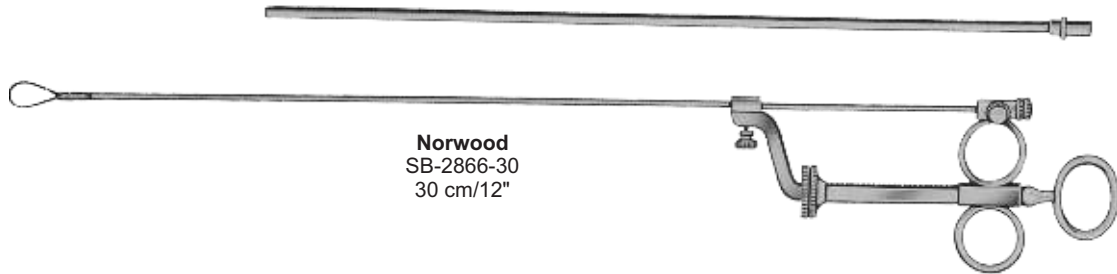

Norwood
SB-2866-30
30 cm/12"

Rectal Aspiration Cannula
Rectal Aspirationskanüle
Canule aspiration rectale
Cánula de aspiración recto

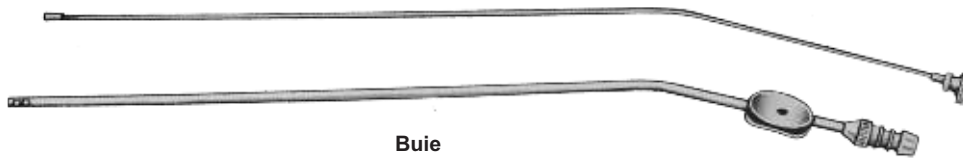

Buie
SB-2867-40
Charr. 10. 40 cm/15¾"

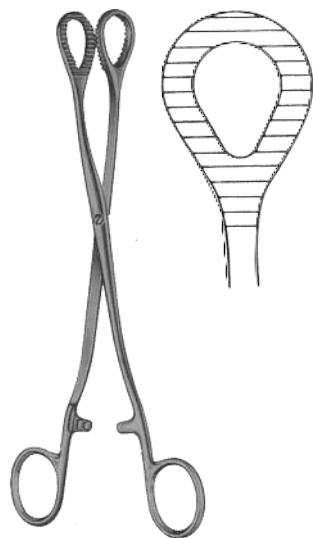

Heywood-Smith
SB-2868-20
20 cm/8"

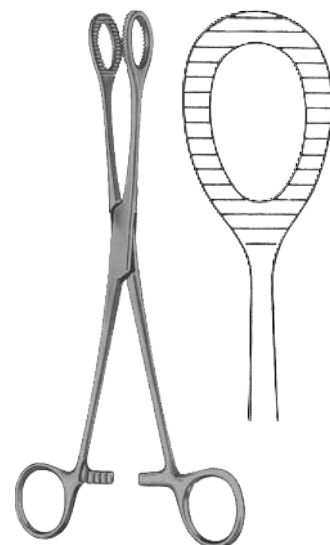

Heywood-Smith
SB-2869-21
21 cm/8¼"

Stomach, Intestine and Rectum Instruments

Haemorrhoidal Ligators
Haemorrhoidal Ligatur

Ligators Haemorrhorial
Ligaturs Haemorrhorial

Aspiration Tip

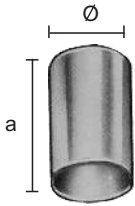

| | a | Ø |
|------------|-------|-------|
| SB-2870-11 | 11 mm | 10 mm |
| SB-2870-16 | 16 mm | 10 mm |

Charging Cone



10 mm Ø

Charging Cone



12 mm Ø

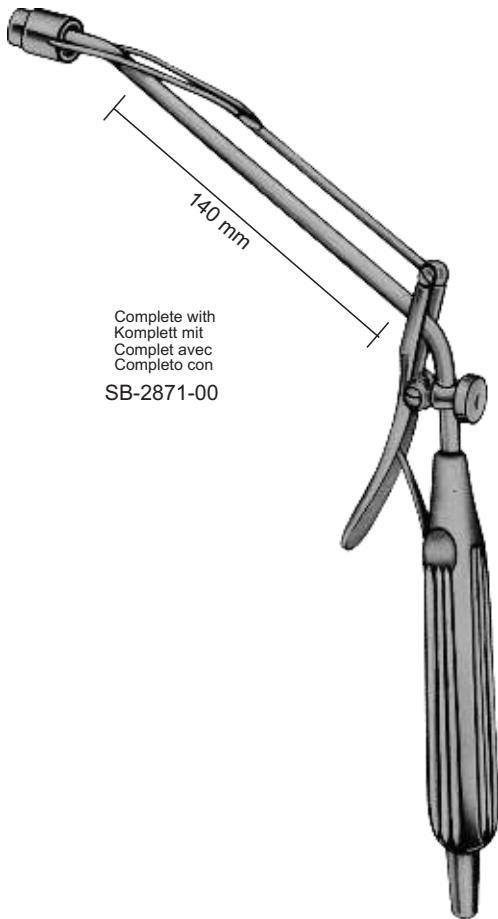

Complete with
Komplett mit
Complet avec
Completo con
SB-2871-00

Migivney

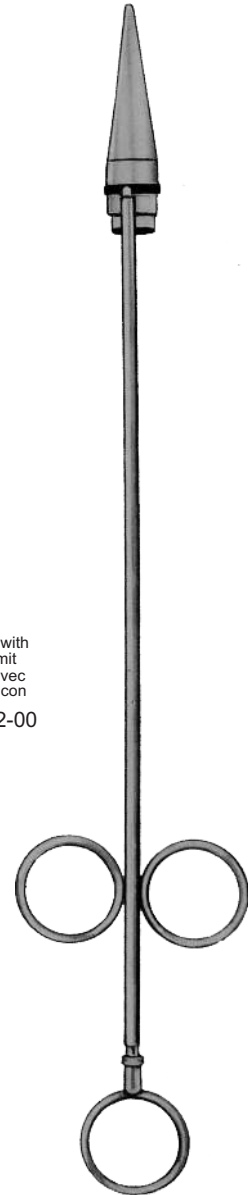

Complete with
Komplett mit
Complet avec
Completo con
SB-2872-00

Rudd
31.5 cm/12½"

Dermatology Instruments

Comedone Extractors and Skin Currettes
Komedos Extraktoren und Haut-Küretten

Extracteurs comédon et Currettes de la peau
Extractores y comedones Curetas la piel



Complete with
Komplett mit
Complet avec
Completo con
SB-2873-00

McGivney
SB-2873-01



SB-2873-21

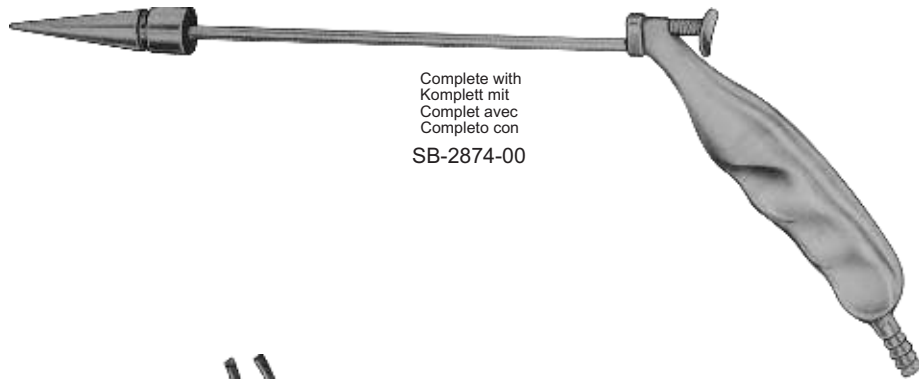

Complete with
Komplett mit
Complet avec
Completo con
SB-2874-00

18-2574-01



McGivney
SB-2875-19
19 cm/7½"



Serving Health Care

SPEED BIRD ENTERPRISES



**161/C, SMALL INDUSTRIAL ESTATE
SIALKOT-51310, (PAKISTAN)**



: +92-304 0549944



: +92-52-3555584



: speed@birddent.com



: www.birddent.com