



Serving Health Care

SPEED BIRD
ENTERPRISES

www.birddent.com

CARDIOVASCULAR INSTRUMENTS

SECTION

13

Cardiovascular Instruments

Rib Shears
Rib Shears

Costotome
Tijeras de costilla



SB-2444-23
23 cm/9"
Bone Shears



SB-2445-23
23 cm/9"
Bone Shears



Glick
SB-2446-23
23 cm/9"
Drawing Cut

Cardiovascular Instruments

Rib Shears, Sternum Chisels
Rib, Sternumscheren Meißel

Costotome, ciseaux Sternum
Tijeras de costillas, esternón cinceles



Sauerbruch
SB-2447-24 24 cm/9½"
SB-2447-26 26 cm/10 ¼"



Giertz-Stillle
SB-2448-27
27 cm/10½"



Sauerbruch-Frey
SB-2449-36
36 cm/14"



Brunner
32 cm/12½"

SB-2450-32
For the Right Hand
Für die rechte Hand
Pour la main droite
Para la mano derecha

SB-2451-32
For the left Hand
Für die linke Hand
Pour la main gauche
Para la mano izquierda



Lebsche
SB-2452-24
24.5 cm/9¾"

Cardiovascular Instruments

Rib Spreaders
Wundsperrerr

Épandeurs Rib
Separadores de costilla

Schema of Dimensions
Schema der Dimensionen
Schéma des dimensions
Esquema de Medidas

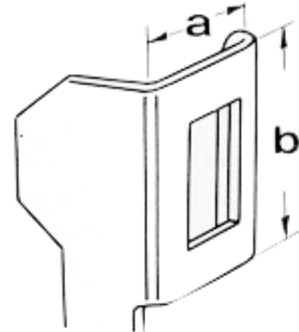

Size of Blades
Größe der Blätter
Taille des lames
Tamaño de Espadas

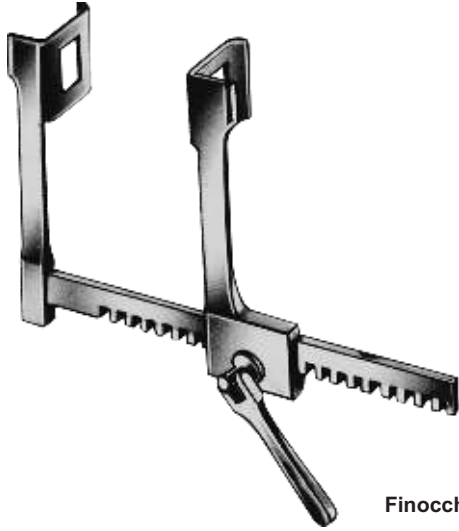

Finocchietto-Baby

| | a | b | c |
|------------|-------|-------|-------|
| SB-2453-00 | 18 mm | 20 mm | 75 mm |

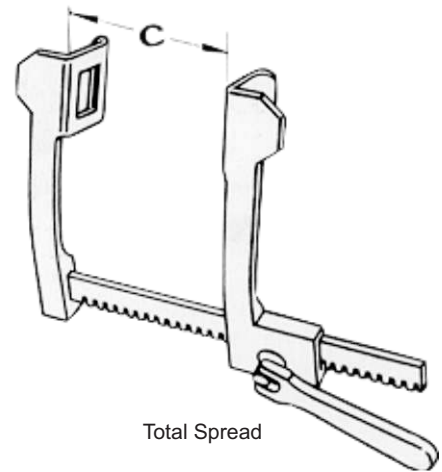

Total Spread

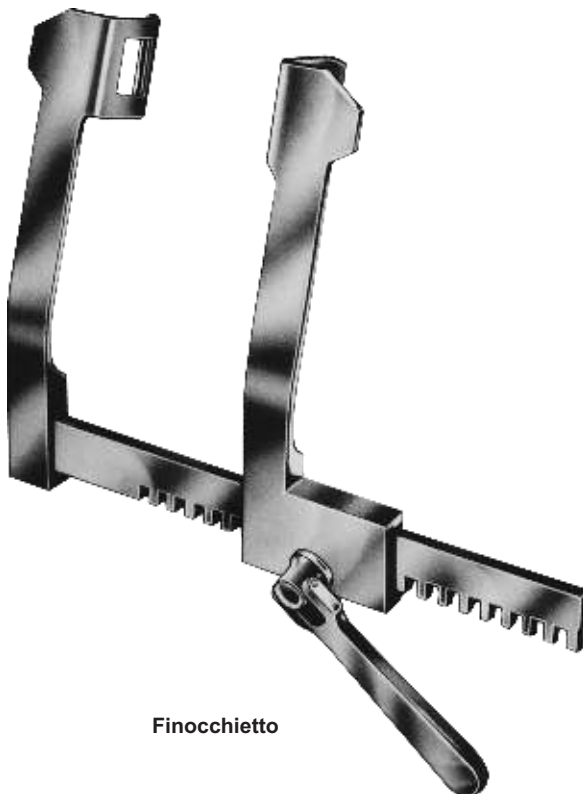

Finocchietto

| | a | b | c |
|------------|-------|-------|--------|
| SB-2454-01 | 38 mm | 45 mm | 165 mm |
| SB-2454-02 | 44 mm | 65 mm | 200 mm |
| SB-2454-03 | 44 mm | 65 mm | 250 mm |
| SB-2454-04 | 44 mm | 65 mm | 300 mm |
| SB-2454-05 | 65 mm | 65 mm | 200 mm |
| SB-2454-06 | 65 mm | 65 mm | 250 mm |
| SB-2454-07 | 65 mm | 65 mm | 300 mm |

Cardiovascular Instruments

Rib Spreaders
Wundsperrer

Épandeurs Rib
Separadores de costilla

With 2 Pairs of Interchangeable Blades
Mit 2 Paar Wechselklingen
Avec 2 paires de lames interchangeables
Con 2 pares de cuchillas intercambiables

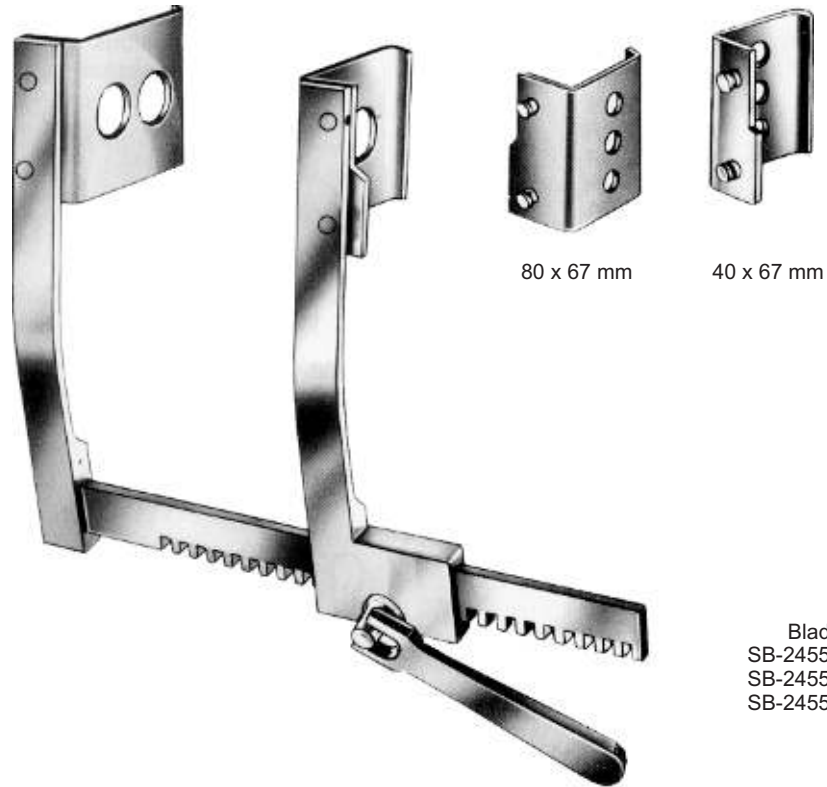

Tuffier

Cardiovascular Instruments

Rib Spreaders
Wundsperrer

Épandeurs Rib
Separadores de costilla

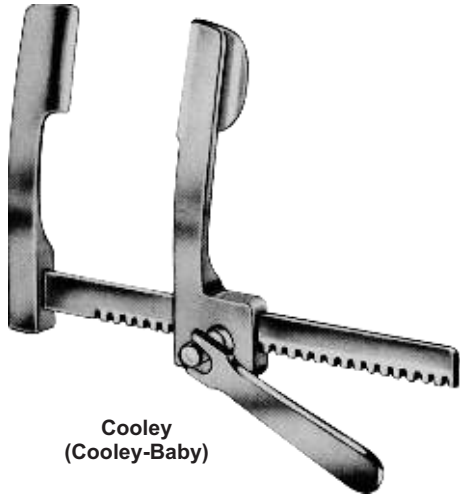

Cooley
(Cooley-Baby)

| | a | b | c |
|------------|-------|-------|--------|
| SB-2457-01 | 12 mm | 17 mm | 75 mm |
| SB-2457-02 | 16 mm | 30 mm | 105 mm |
| SB-2457-03 | 37 mm | 49 mm | 200 mm |



Castaneda

| | a | b | c |
|------------|---------|-------|--------|
| SB-2458-01 | 10.5 mm | 32 mm | 65 mm |
| SB-2458-02 | 12 mm | 45 mm | 70 mm |
| SB-2458-03 | 15 mm | 60 mm | 120 mm |

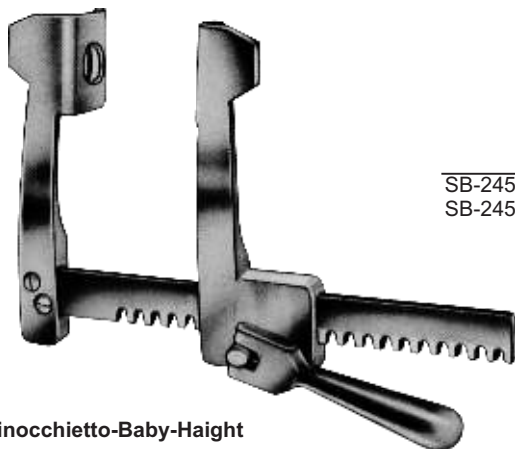

Finocchietto-Baby-Haight

| | a | b | c |
|------------|-------|-------|--------|
| SB-2459-01 | 15 mm | 15 mm | 75 mm |
| SB-2459-02 | 31 mm | 31 mm | 100 mm |

Cardiovascular Instruments

Rib Spreaders
Wundsperrer

Épandeurs Rib
Separadores de costilla



Haight

| | a | b | c |
|------------|-------|-------|-------|
| SB-2460-01 | 30 mm | 30 mm | 65 mm |
| SB-2460-02 | 30 mm | 30 mm | 90 mm |

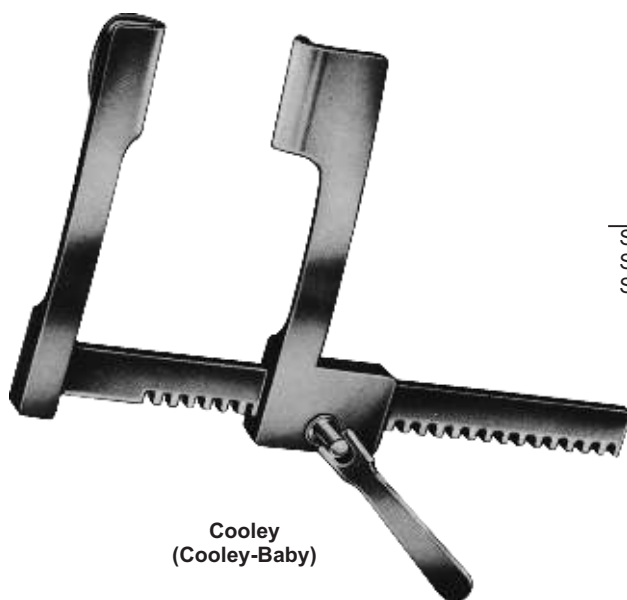

Cooley
(Cooley-Baby)

| | a | b | c |
|------------|-------|-------|--------|
| SB-2461-01 | 15 mm | 30 mm | 75 mm |
| SB-2461-02 | 21 mm | 45 mm | 145 mm |
| SB-2461-03 | 32 mm | 50 mm | 190 mm |

Cardiovascular Instruments

Rib Spreaders
Wundsperrer

Épandeurs Rib
Separadores de costilla

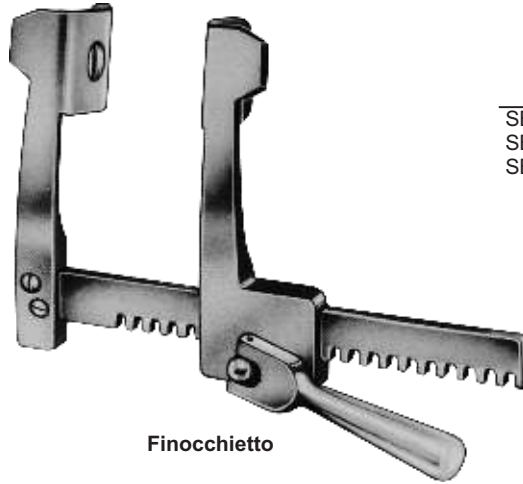

Finocchetto

| | a | b | c |
|------------|-------|-------|--------|
| SB-2462-01 | 38 mm | 44 mm | 135 mm |
| SB-2462-02 | 52 mm | 62 mm | 175 mm |
| SB-2462-03 | 85 mm | 65 mm | 175 mm |

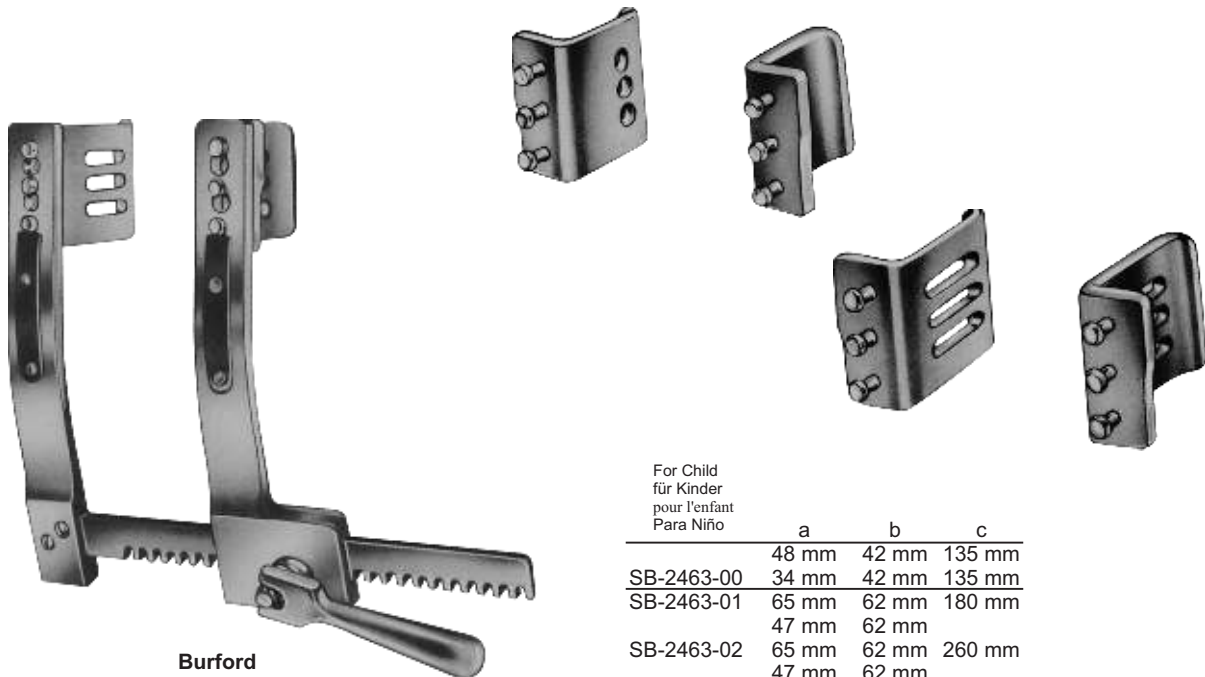

Burford

With 2 Pairs of Blades
Mit 2 Paar Blades
Avec 2 paires de lames
Con 2 pares de hojas

For Child
für Kinder
pour l'enfant
Para Niño

| | a | b | c |
|------------|-------|-------|--------|
| SB-2463-00 | 48 mm | 42 mm | 135 mm |
| SB-2463-01 | 34 mm | 42 mm | 135 mm |
| SB-2463-02 | 65 mm | 62 mm | 180 mm |
| | 47 mm | 62 mm | |
| SB-2463-02 | 65 mm | 62 mm | 260 mm |
| | 47 mm | 62 mm | |
| SB-2463-03 | 65 mm | 62 mm | 300 mm |
| | 47 mm | 62 mm | |

Cardiovascular Instruments

Rib Spreaders
Wundsperrer

Épandeurs Rib
Separadores de costilla

With 2 pairs of interchangeable blades
Mit 2 Paar auswechselbaren Klingen
Avec 2 paires de lames interchangeables
Con 2 pares de hojas intercambiables

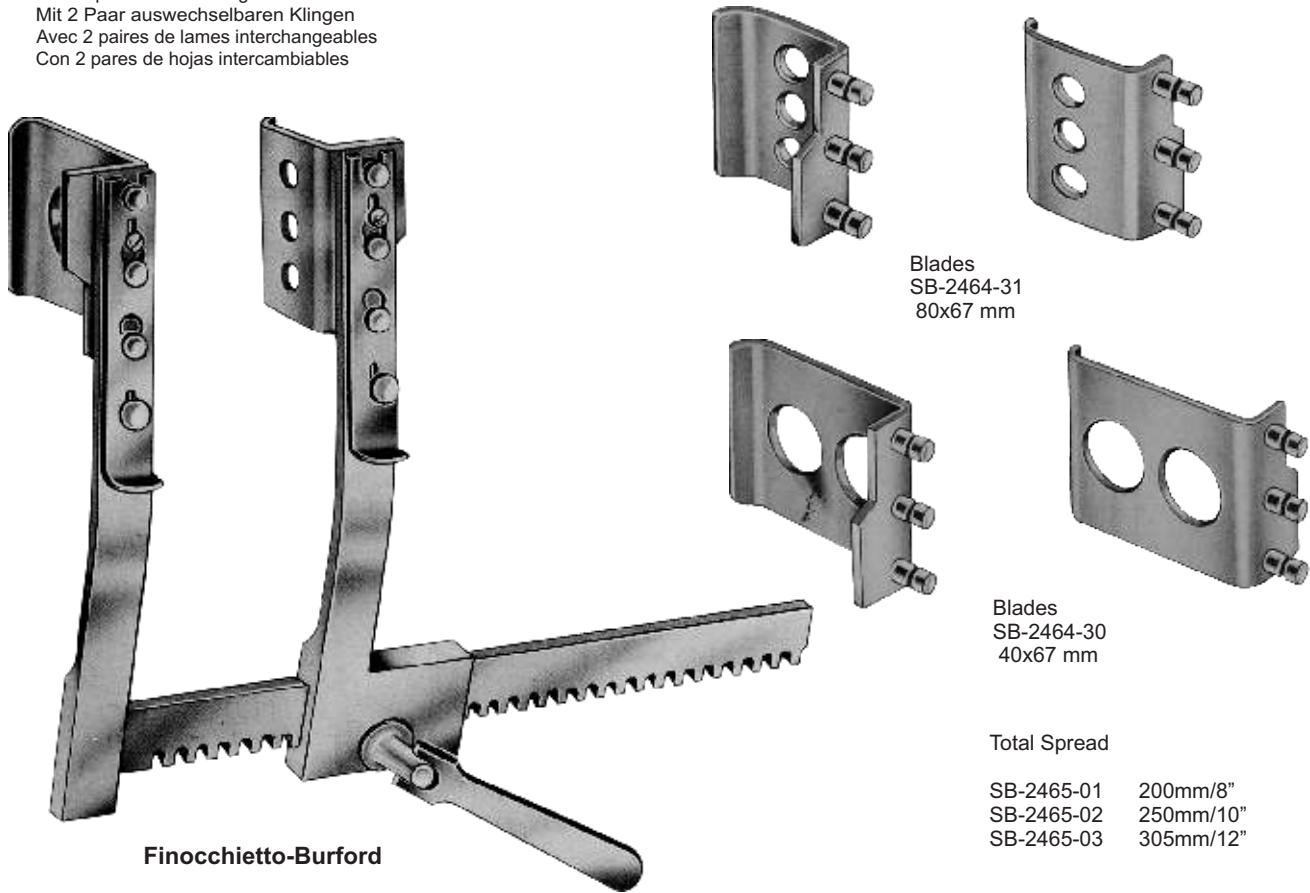

Finocchietto-Burford

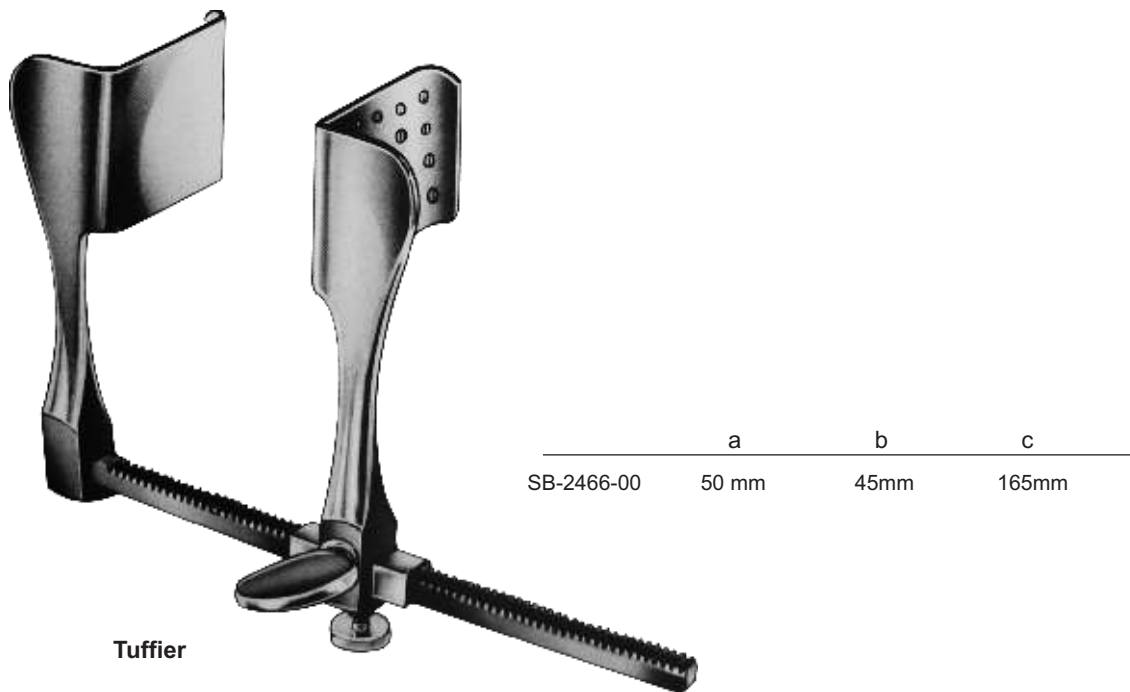

Tuffier

Cardiovascular Instruments

Rib Spreaders
Wundsperrerr

Épandeurs Rib
Separadores de costilla

◀ 200 mm ▶

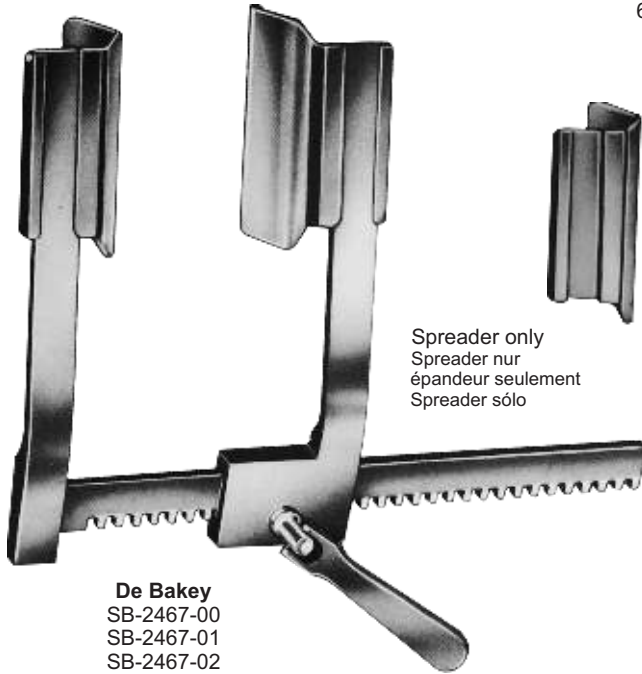

De Bakey
SB-2467-00
SB-2467-01
SB-2467-02
SB-2467-03

With 5 Pairs of Blades
Mit 5 Paar Blades
Avec 5 paires de lames
Con 5 pares de cuchillas

Spreader only
Spreader nur
épandeur seulement
Spreader sólo



SB-2467-01
60 x 60 mm



SB-2467-02
50 x 80 mm



SB-2467-03
40 x 100 mm



SB-2467-04
80 x 60 mm



SB-2467-05
50 x 66 mm



◀ 150 mm ▶

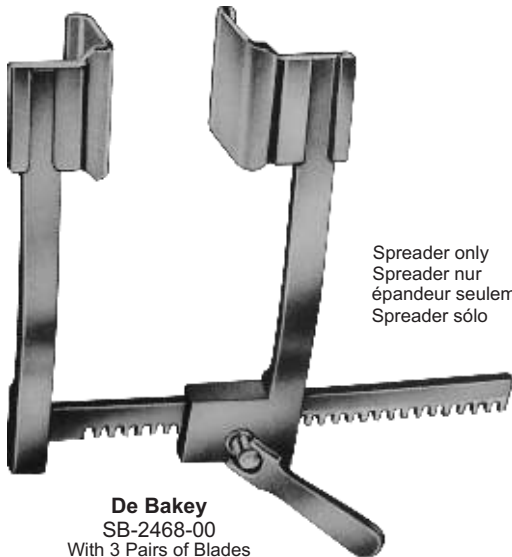

De Bakey
SB-2468-00
With 3 Pairs of Blades
Mit 3 Paar Blades
Avec 3 paires de lames
Con 3 pares de cuchillas

Spreader only
Spreader nur
épandeur seulement
Spreader sólo



SB-2468-01
30 x 30 mm



SB-2468-02
40 x 40 mm



SB-2468-03
50 x 50 mm



Cardiovascular Instruments

Rib Spreaders
Wundsperrer

Épandeurs Rib
Separadores de costilla

◀ Fig. 1 15 cm/6" ▶
◀ Fig. 2 20 cm/8" ▶

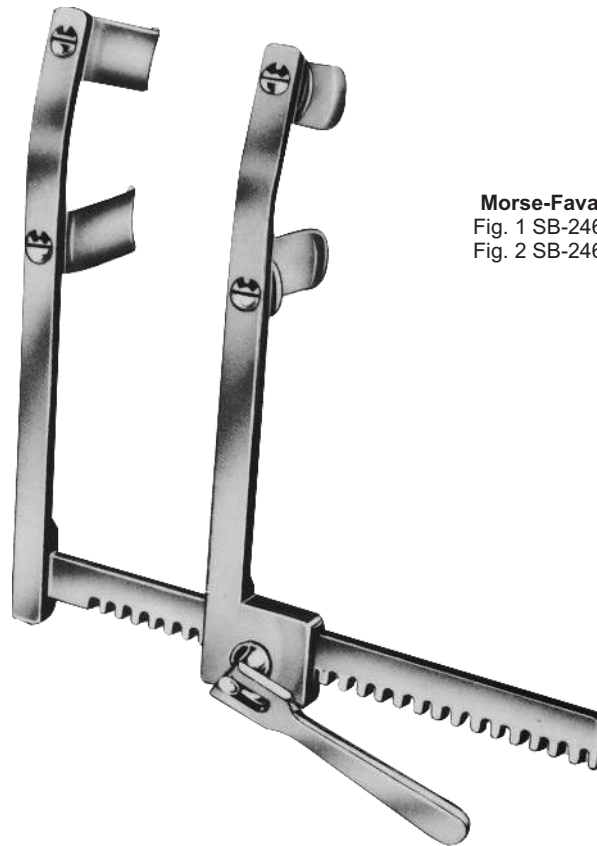

Morse-Favaloro
Fig. 1 SB-2469-01
Fig. 2 SB-2469-02

75 x 75 mm

Thoracic Retractor



42 x 65 mm



(Mercedes-Retractor)
SB-2470-00

Complete
vervollständigen
completar
completar

Cardiovascular Instruments

Rib Contractors and Lung Spatulas

Rib Contractors und Lungenforschung Spatel

Entrepreneurs des côtes et du poumon Spatules

Contratistas de costilla y espátulas de pulmón



Sellors
SB-2471-19
19 cm/7½"



Bailey-Baby
SB-2472-14
14 cm/5½"



Bailey
SB-2473-16
16 cm/6¼"



Bailey-Gibbon
SB-2474-16
16 cm/6¼"

Cardiovascular Instruments

Lung Spatulas
Lung Spatel

Spatules du poumon
Espátulas de pulmón



Allison
SB-2475-25 25.5 cm/10"
SB-2475-30 30.0 cm/12"

Lung Spatulas
Lung Spatel
Spatules pulmonaires
Espátulas de pulmón

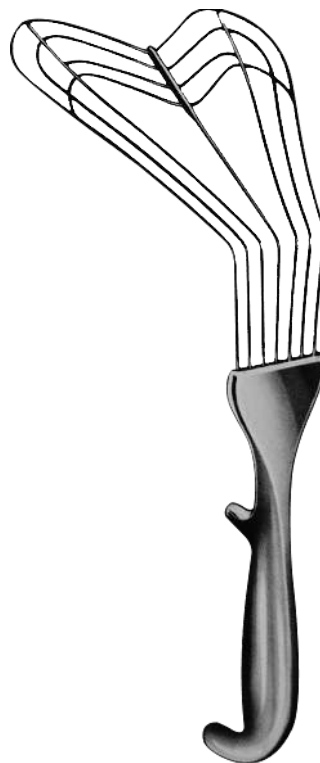

SB-2476-30
30 cm/12"

Cardiovascular Instruments

Bronchus Clamps and Blood Vessel Clamps
Bronchus Schellen und Blutgefäßen Schellen

Pinces des bronches et des colliers Vasculopathies
Abrazaderas Abrazaderas de los bronquios y los vasos
sanguíneos

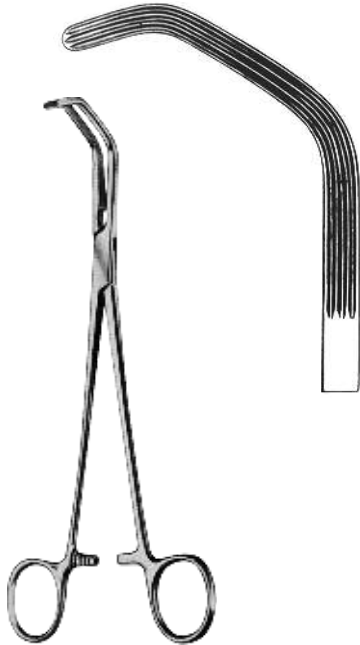

Price-Thomas
SB-2477-22
22 cm/8¾"

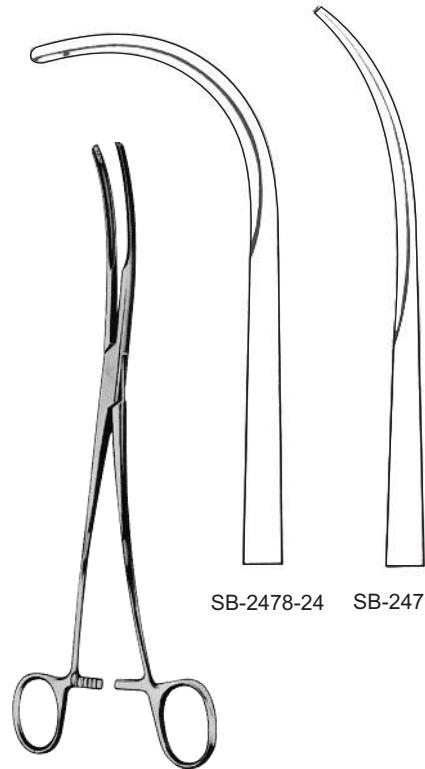

Semb
24 cm/9½"

SB-2478-24 SB-2479-24

Lung grasping forceps



Lovlace
SB-2480-20
20 cm/8"



Lovlace
SB-2481-20
20 cm/8"

Cardiovascular Instruments

Blood Vessel Clamps
Blutgefäß Schellen

Pinces Vasculopathies
Las abrazaderas de los vasos sanguíneos



SB-2482-01
SB-2482-02

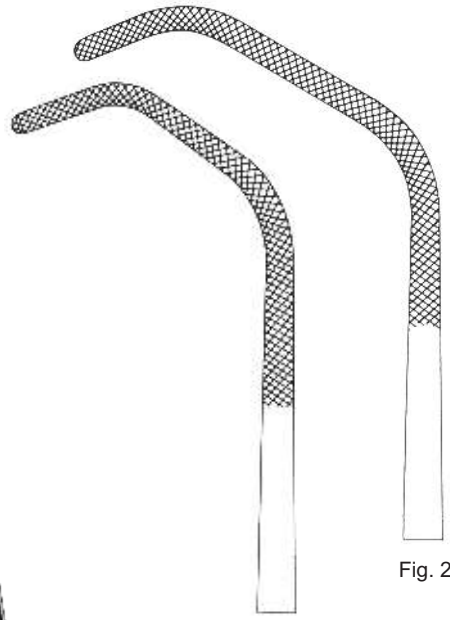

Fig. 2

Fig. 1

Satinsky
26.5 cm/10½"
Fig. 1
Fig. 2



SB-2483-01
SB-2483-02



Baby-Satinsky
SB-2484-15
15 cm/6"



Harken
24 cm/9½"



SB-2485-01



SB-2485-02



SB-2485-03



SB-2485-04

Cardiovascular Instruments

Atrauma Bulldog Clamps
Atrauma Bulldogklemmen

Atraumatique Pinces Bulldog
Atrauma Bulldog Clamps



De Bakey-Satinsky
SB-2486-07
7 cm/2³/₄"



De Bakey-Satinsky
SB-2487-09
9 cm/3¹/₂"

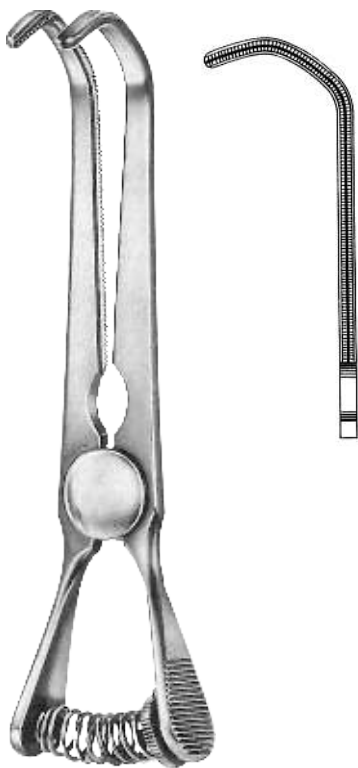

De Bakey-Satinsky
SB-2488-10
10 cm/4"



Glover
SB-2489-06
6 cm/2¹/₄"

Cardiovascular Instruments

Atrauma Bulldog Clamps
Atrauma Bulldogklemmen

Atraumatique Pincès Bulldog
Atrauma Bulldog Clamps



Santulli
SB-2490-07
7 cm/2¾"

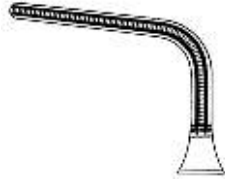

Gregory-Soft

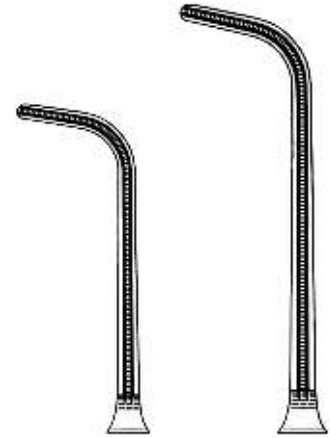

SB-2491-09
9 cm/3½"

SB-2491-11
11 cm/4½"



Gregory



SB-2492-09
10.5 cm/4"



SB-2492-10
10.5 cm/4"

Cardiovascular Instruments

Bulldog Clamps
Bulldogklemmen

Pinces Bulldog
Bulldog Clamps



Glover



SB-2493-09
7cm/2¾"



SB-2494-11
7.5 cm/3"



SB-2495-09
9 cm/3½"



SB-2496-11
11 cm/4¼"

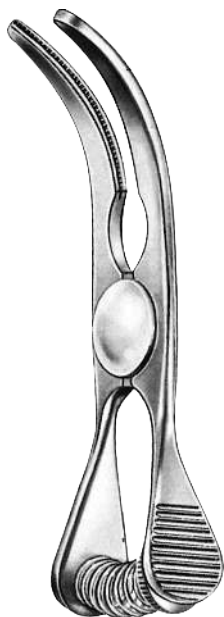

Glover



SB-2497-09
6.5cm/2½"



SB-2498-11
7 cm/2¾"



SB-2499-09
8.5 cm/3¼"



SB-2500-11
10.5 cm/4"

Cardiovascular Instruments

Bulldog Clamps
Bulldogklemmen

Pincas Bulldog
Bulldog Clamps



DeBakey

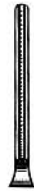

SB-2501-07
7.5 cm/3"



SB-2501-08
8.5 cm/3 1/4"



SB-2501-10
10 cm/4"



SB-2501-12
12 cm/4 3/4"

Applying Forceps
for Bulldog clamps

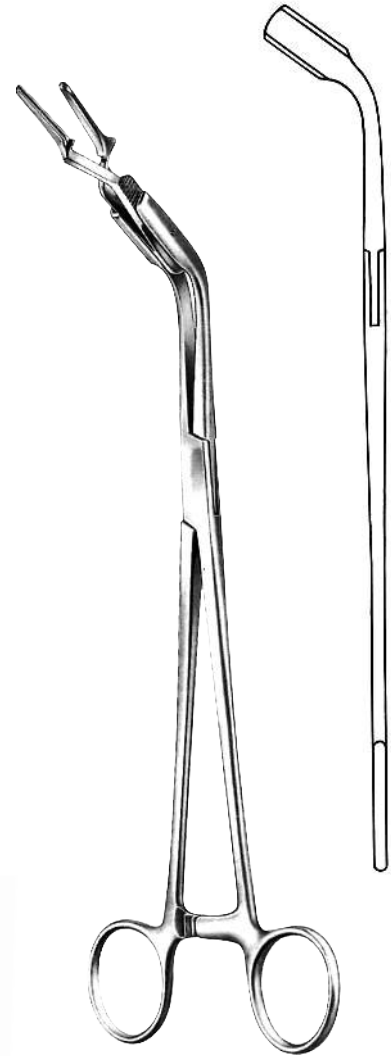

SB-2503-23
23.5 cm/9 1/4"



DeBakey



SB-2502-07
7.5 cm/3"



SB-2502-08
8.5 cm/3 1/4"



SB-2502-09
9.5 cm/4 3/4"



SB-2502-12
11 cm/4 1/4"

Cardiovascular Instruments

Haemostatic Forceps and Aortic Clamps
Arterienklemme und Aorten-Schellen

Forceps Hémostatique et clamps aortiques
Pinzas hemostáticas y Abrazaderas aórticas

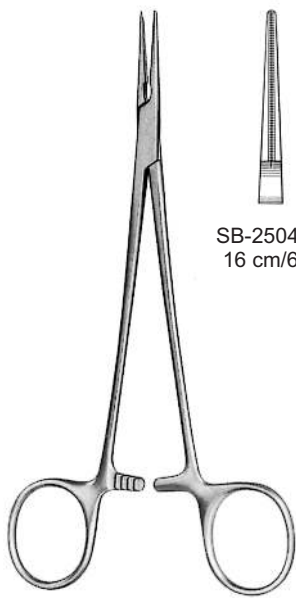

DeBakey-Rankin



SB-2504-01
16 cm/6 1/4"



SB-2504-02
16 cm/6 1/4"

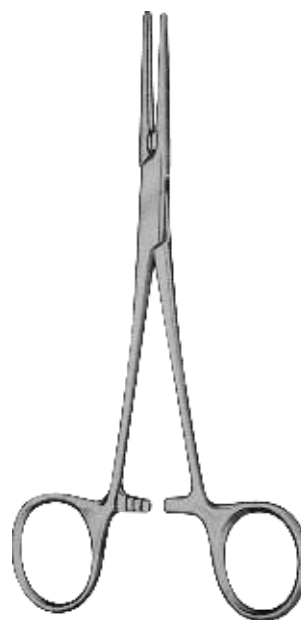

DeBakey-Mosquito



SB-2505-01
15 cm/6"



SB-2505-02
16 cm/6"



Ochsner



SB-2506-23
23.5 cm/9 1/4"

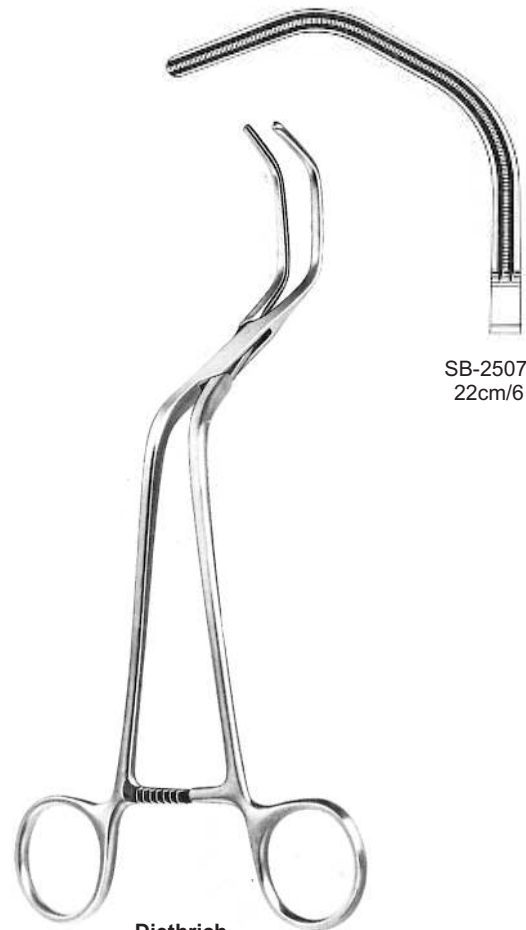

Diethrich



SB-2507-22
22cm/6 3/4"

Cardiovascular Instruments

Multi Purpose vascular Clamps
Multi Purpose Gefäßklemmen

Pinces Multi Purpose vasculaires
Pinzas Multiuso vasculares



SB-2508-00



15°
SB-2508-15



30°
SB-2508-30



45°
SB-2508-45

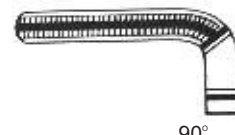

90°
SB-2508-90



SB-2509-00

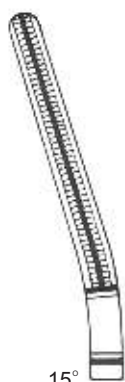

15°
SB-2509-15

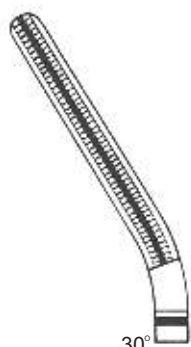

30°
SB-2509-30



45°
SB-2509-45



90°
SB-2509-90



Dardik
17 cm/6³/₄"

Cardiovascular Instruments

Peripheral Vascular Clamps
Peripheral Vascular Clamps

Clamps vasculaires périphériques
Pinzas vasculares periféricas

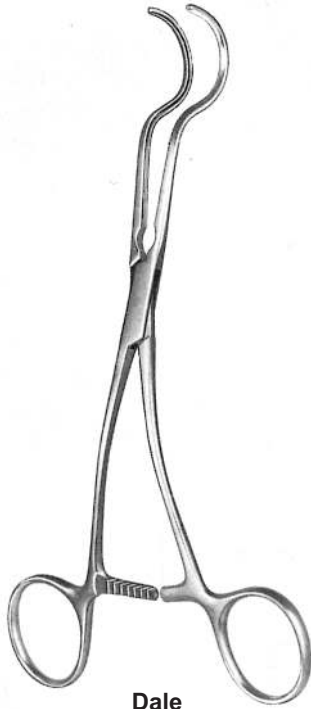

Dale



SB-2510-17
17.5 cm/6¾"



SB-2510-18
18 cm/7"

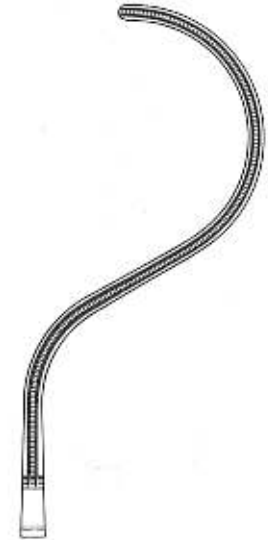

SB-2510-19
18.5 cm/7¼"



Dale

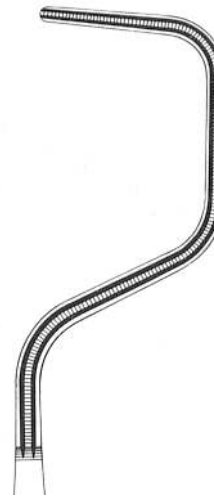

SB-2511-18
18 cm/7"

Cardiovascular Instruments

Profunda and Carotid shunt Clamps
Profunda und Karotis-Shunt-Schellen

Pinces shunt profunda et carotidienne
Profunda y abrazaderas de derivación carotídea

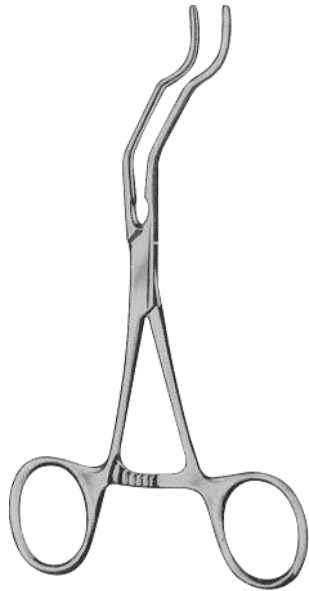

Gregory



SB-2512-14
13 cm/5"

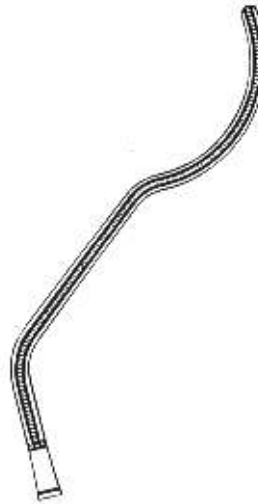

SB-2512-16
16 cm/6 1/4"

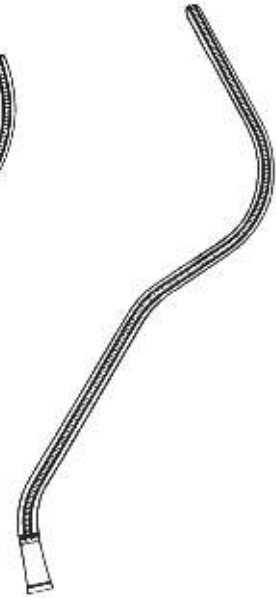

SB-2512-18
18 cm/7"



Javid



SB-2513-17
17.5 cm/7"

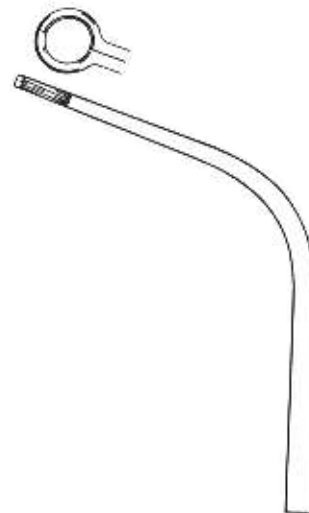

SB-2513-18
18 cm/7"

Cardiovascular Instruments

Catheter Clamps
Katheter-Klemmen

Pinces cathéter
Abrazaderas catéter

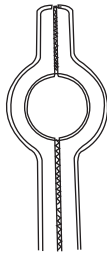

SB-2514-01
16 cm/6 1/4"
24 Charr

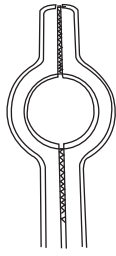

SB-2514-02
16 cm/6 1/4"
26 Charr

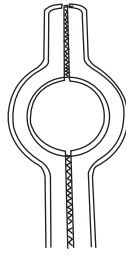

SB-2514-03
20 cm/8"
28 Charr

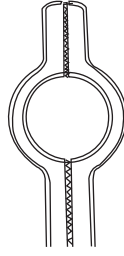

SB-2514-04
20 cm/8"
30 Charr

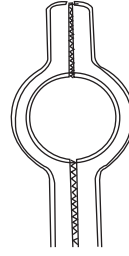

SB-2514-05
20 cm/8"
32 Charr

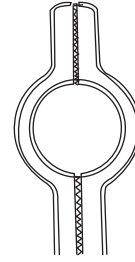

SB-2514-07
20 cm/8"
36 Charr

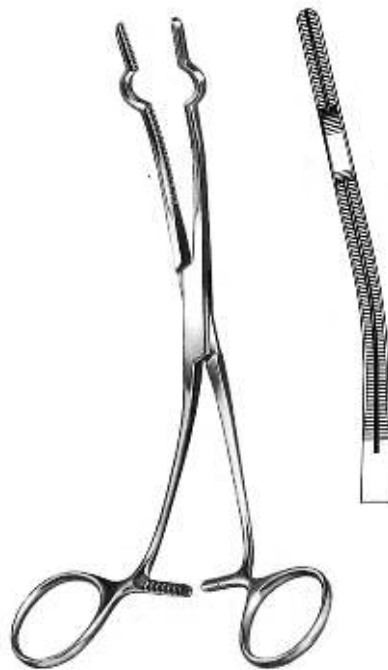

Cooley

Cardiovascular Instruments

Vascular Forceps
Vaskuläre Zange

Pince vasculaires
Pinzas vasculares

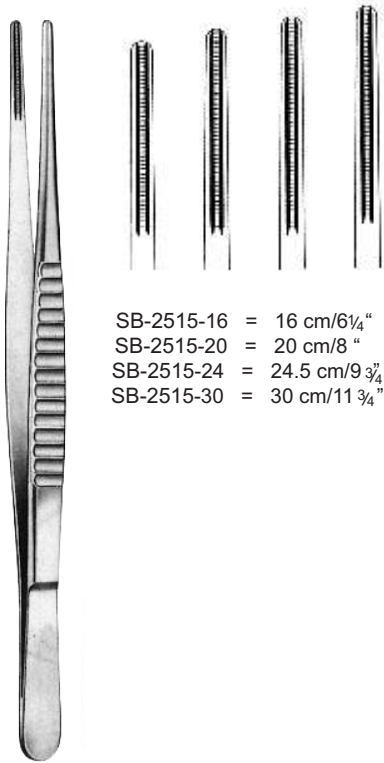

- SB-2515-16 = 16 cm/6 1/4"
- SB-2515-20 = 20 cm/8 "
- SB-2515-24 = 24.5 cm/9 3/4"
- SB-2515-30 = 30 cm/11 3/4"

DeBakey
2.7mm

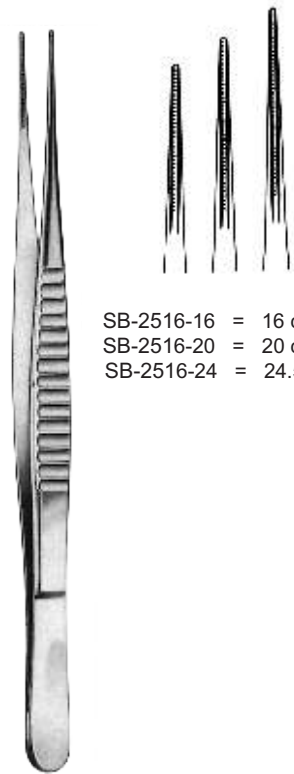

- SB-2516-16 = 16 cm/6 1/4"
- SB-2516-20 = 20 cm/8 "
- SB-2516-24 = 24.5 cm/9 3/4"

DeBakey
1.5mm



- SB-2517-16 = 16 cm/6 1/4"
- SB-2517-20 = 20 cm/8 "
- SB-2517-24 = 24.5 cm/9 3/4"
- SB-2517-30 = 30 cm/11 3/4"

DeBakey
2.5mm

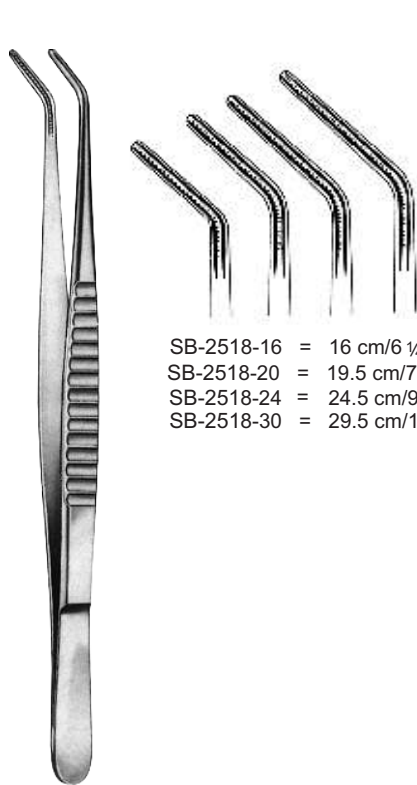

- SB-2518-16 = 16 cm/6 1/4"
- SB-2518-20 = 19.5 cm/7 3/4"
- SB-2518-24 = 24.5 cm/9 "
- SB-2518-30 = 29.5 cm/11 1/4"

DeBakey
2.0mm

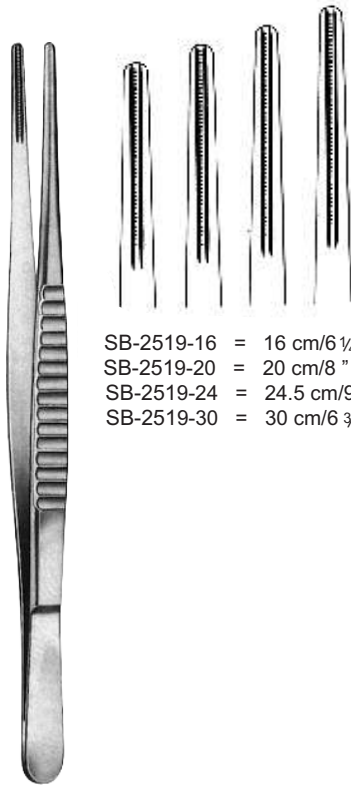

- SB-2519-16 = 16 cm/6 1/4"
- SB-2519-20 = 20 cm/8 "
- SB-2519-24 = 24.5 cm/9 3/4"
- SB-2519-30 = 30 cm/11 3/4"

DeBakey
3.5mm



- SB-2520-16 = 16 cm/6 1/4"
- SB-2520-20 = 20 cm/8 "

DeBakey
2.0mm

Cardiovascular Instruments

Peripheral Vascular Clamps
Peripheral Vascular Clamps

Clamps vasculaires périphériques
Pinzas vasculares periféricas

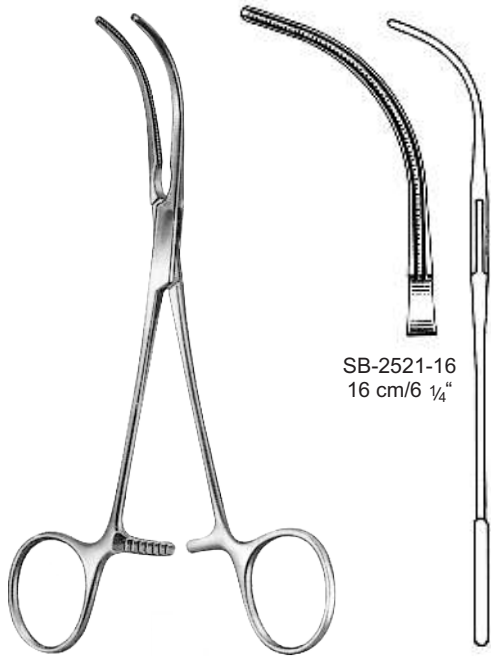

SB-2521-16
16 cm/6 ¼"

DeBakey

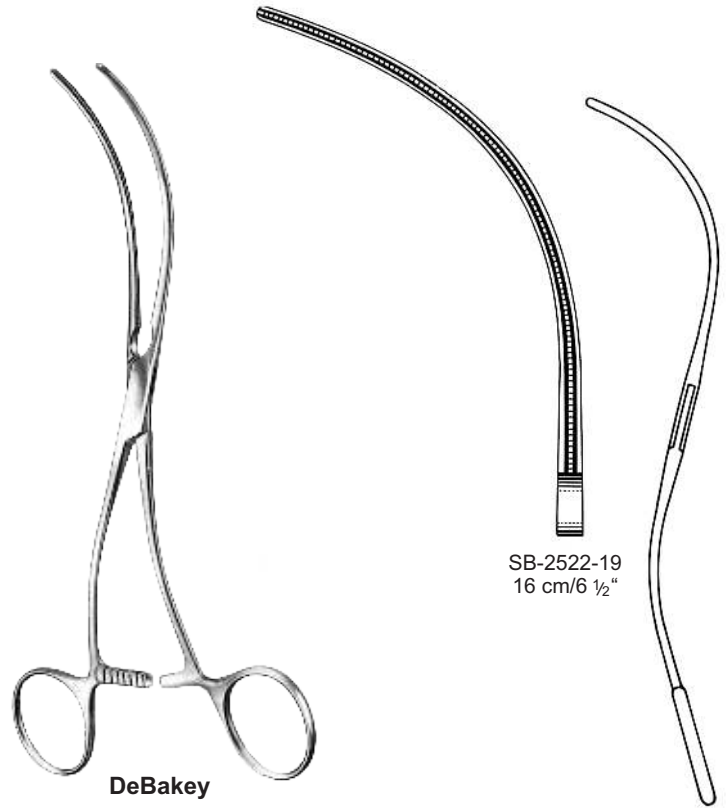

SB-2522-19
16 cm/6 ½"

DeBakey



SB-2523-18
18 cm/6 "

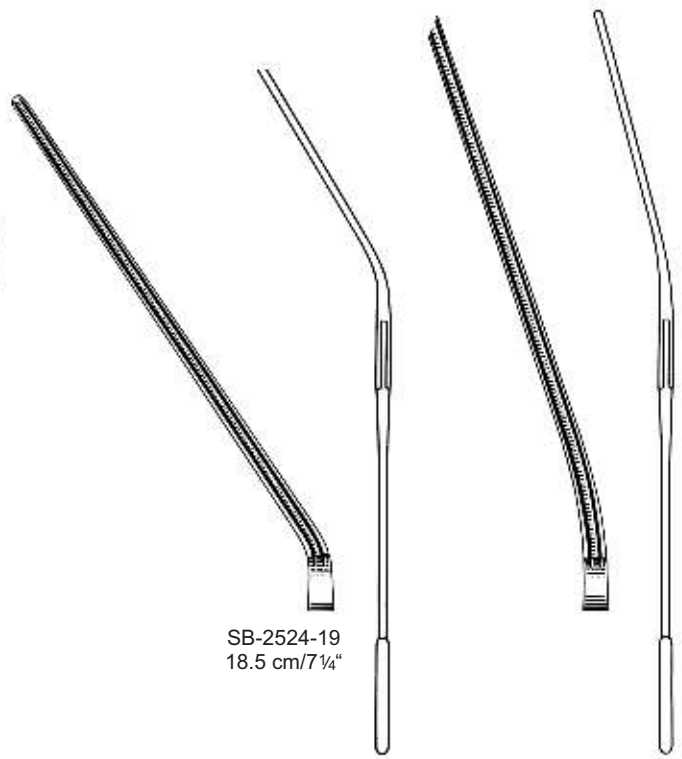

SB-2524-19
18.5 cm/7 ¼"

Cardiovascular Instruments

Multi Purpose Vascular Clamps
Multi Purpose Gefäßklemmen

Pinces Multi Purpose vasculaires
Pinzas Multiuso vasculares

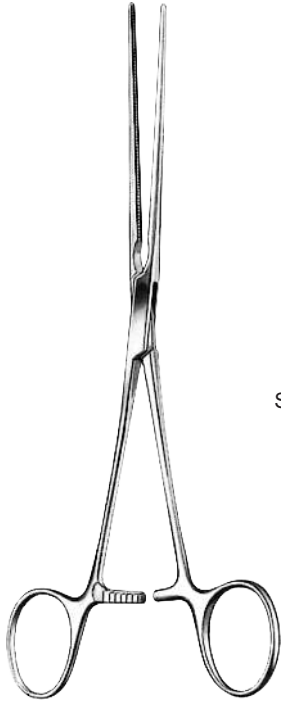

Bainbridge



SB-2525-15
15 cm/6 "



SB-2526-18
18.5 cm/7 ¼"



Bainbridge



SB-2527-15
15 cm/6 "



SB-2528-18
18.5 cm/7 ¼"

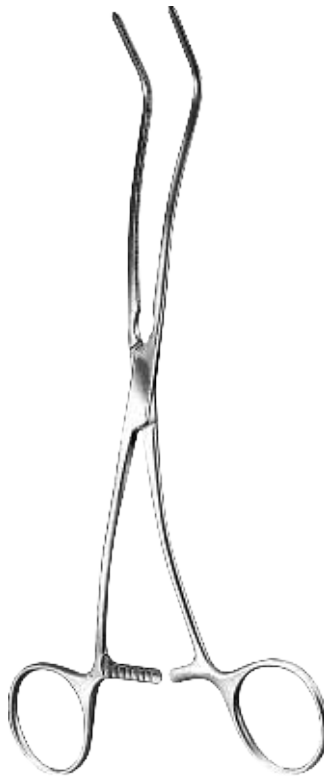

DeBakey

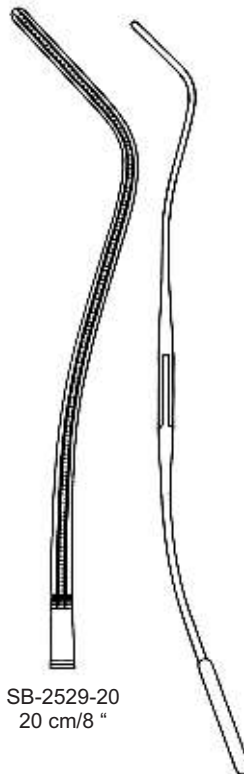

SB-2529-20
20 cm/8 "

Cardiovascular Instruments

Aortic Aneurysm Clamps
Aortenaneurysma Schellen

Pinces anévrisme aortique
Las abrazaderas de aneurismas aórticas

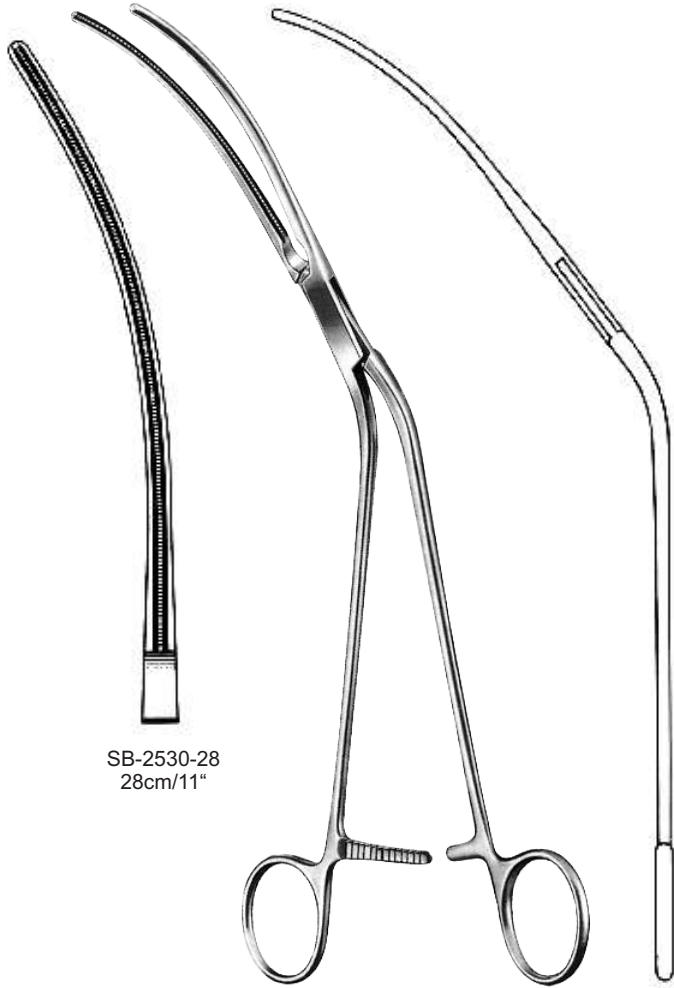

SB-2530-28
28cm/11"

DeBakey

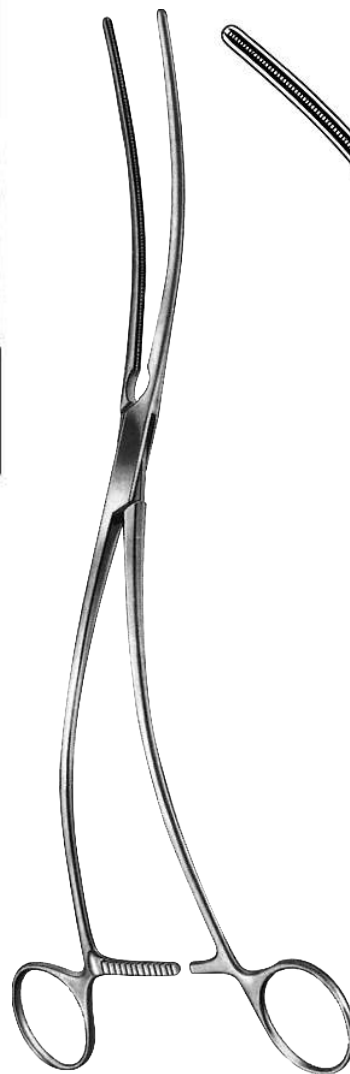

DeBakey

SB-2531-30
30cm/11¾"

Cardiovascular Instruments

Aortic Aneurysm Clamps
Aortenaneurysma Schellen

Pincas anévrisme aortique
Las abrazaderas de aneurismas aórticas



DeBakey



SB-2532-26
26cm/10 1/4"

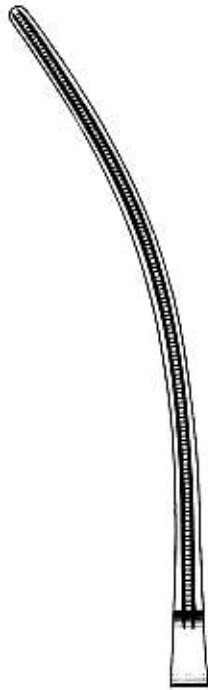

SB-2532-27
26cm/10 3/4"

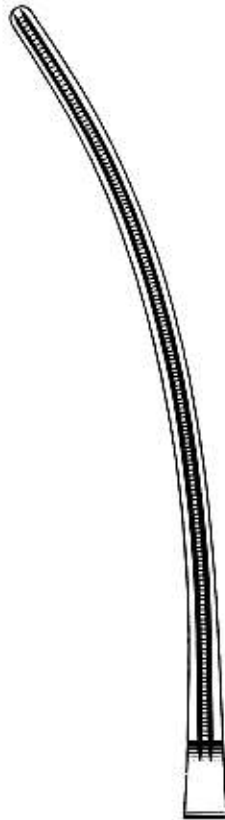

SB-2532-31
31cm/12 1/4"



SB-2532-33
33cm/13"



Cardiovascular Instruments

Aortic Clamps, Ligature Forceps
Aorten-Klemmen, Ligaturklemmen

Clamps aortiques, pinces de ligature
Abrazaderas aórticas, pinzas de ligadura

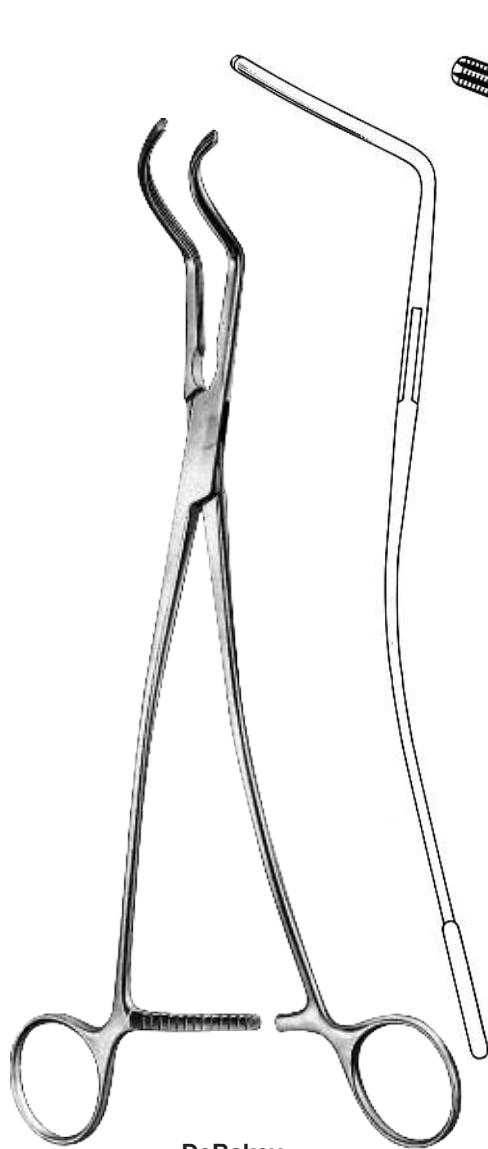

DeBailey
SB-2533-27
27cm/10 3/4"

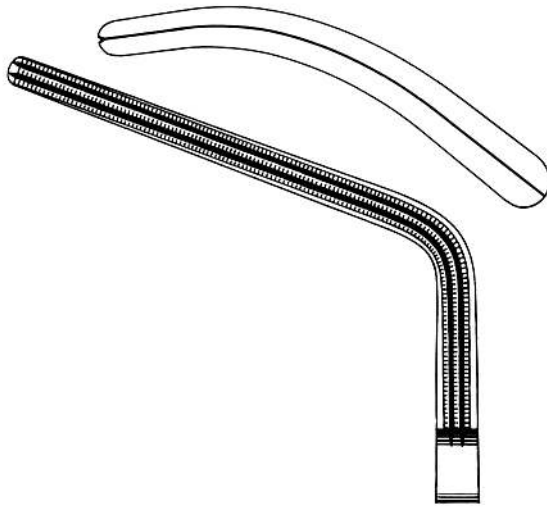

SB-2534-24
24.5cm/9 3/4"

DeBailey

Cardiovascular Instruments

Aortic Clamps, Ligature Forceps
Aorten-Klemmen, Ligaturklemmen

Clamps aortiques, pinces de ligature
Abrazaderas aórticas, pinzas de ligadura

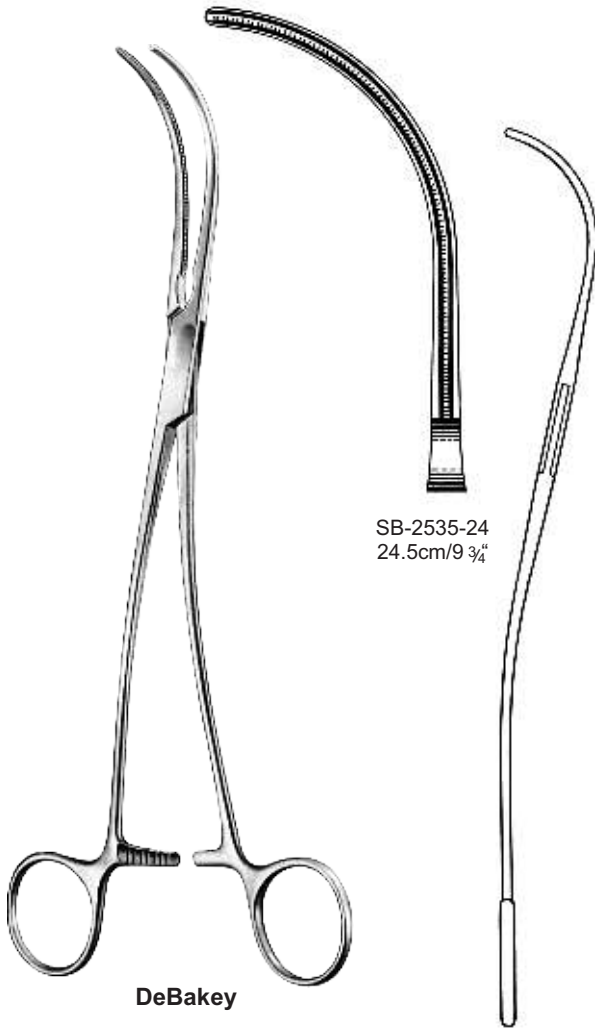

SB-2535-24
24.5cm/9 3/4"

DeBakey

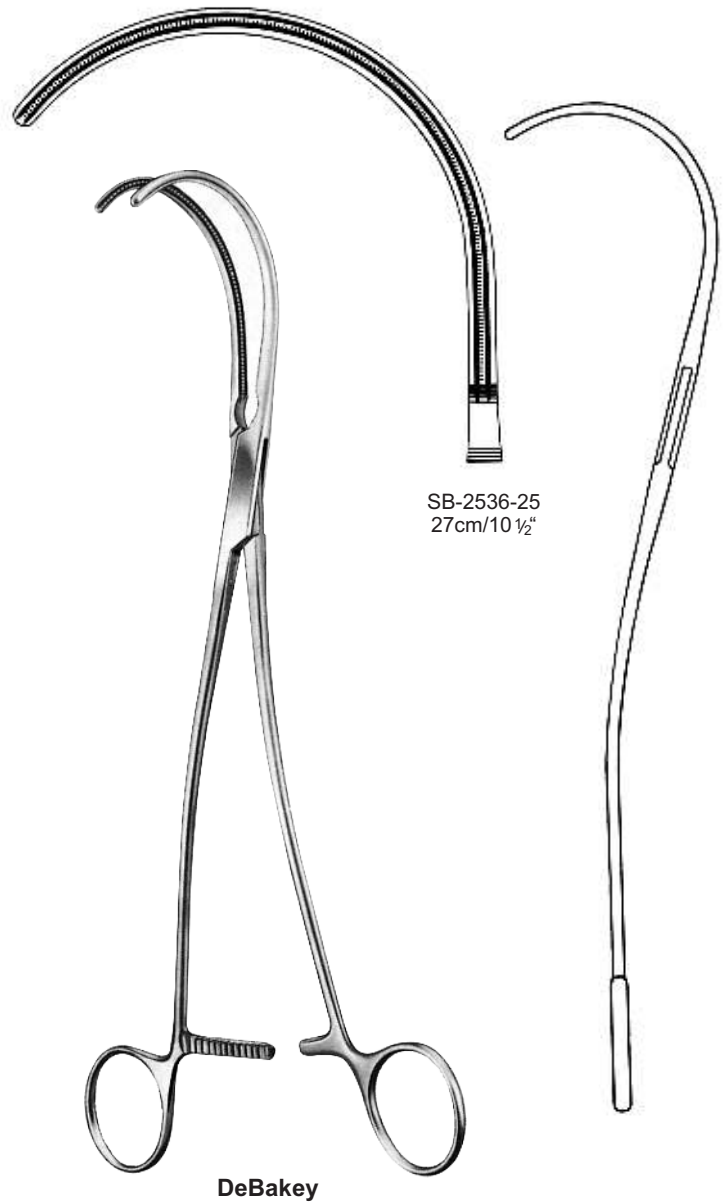

SB-2536-25
27cm/10 1/2"

DeBakey

Cardiovascular Instruments

Aortic Clamps, Ligature Forceps
Aorten-Klemmen, Ligaturklemmen

Clamps aortiques, pincas de ligature
Abrazaderas aórticas, pinzas de ligadura

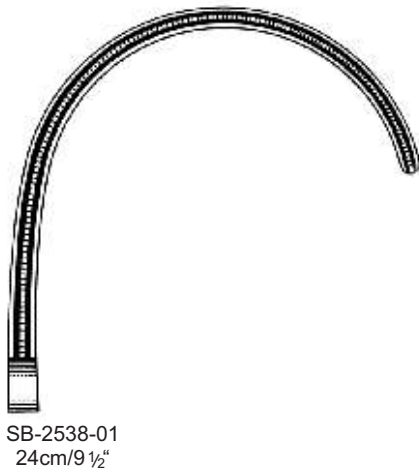
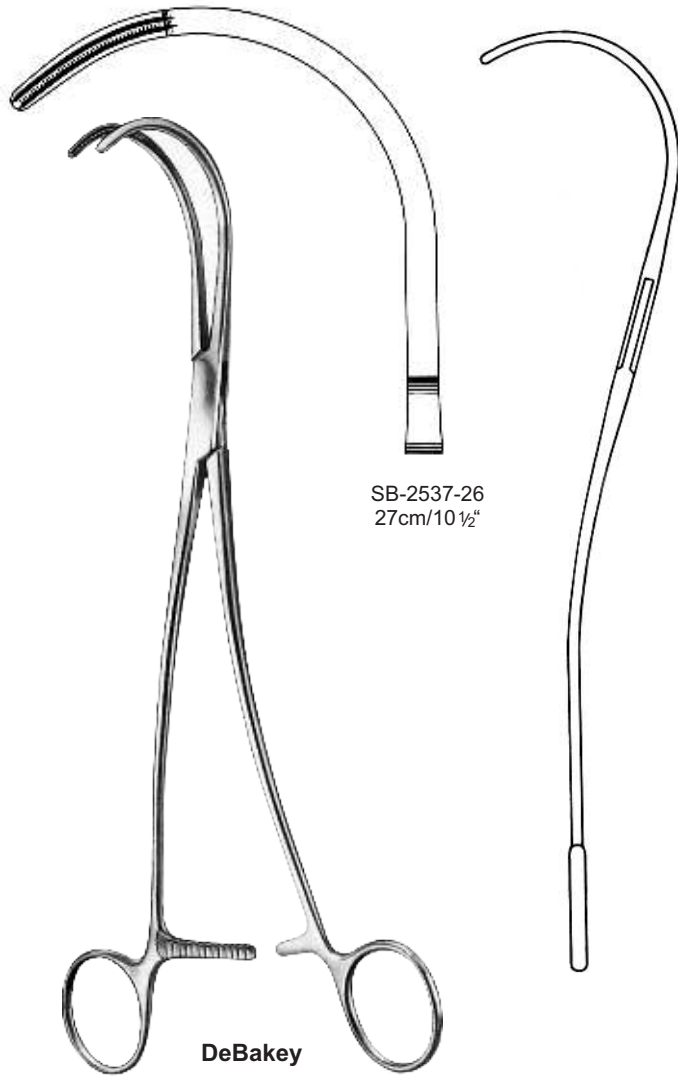

Cardiovascular Instruments

Auricle Clamps
Ohrmuschel Schellen

Pinces oreillette
Abrazaderas aurícula



Harken



SB-2539-01
24.5cm/9 3/4"



SB-2539-02
24.5cm/9 1/2"

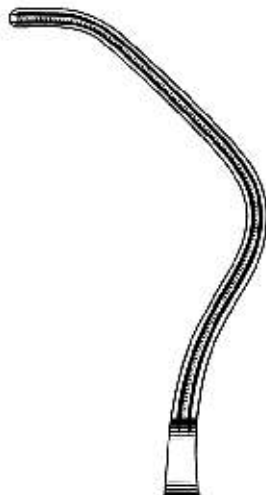

SB-2539-03
24.5cm/9"



SB-2539-04
24.5cm/9 1/4"



Cardiovascular Instruments

Tangential Occlusion Clamps
Tangentielle Occlusion Schellen

Pinces d'occlusion tangentielle
Abrazaderas tangenciales de oclusión



SB-2540-22
22 cm/8 $\frac{3}{4}$ "



SB-2540-26
26 cm/8 $\frac{1}{4}$ "



SB-2540-25
25.5 cm/8 $\frac{1}{2}$ "



Satinsky

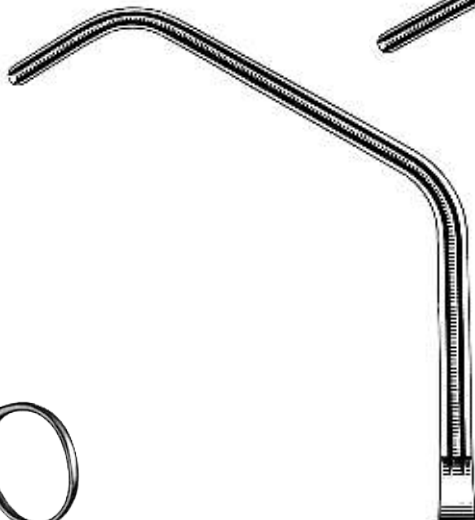

SB-2540-27
27.5 cm/10 $\frac{3}{4}$ "



SB-2540-28
28.5 cm/11 $\frac{1}{4}$ "

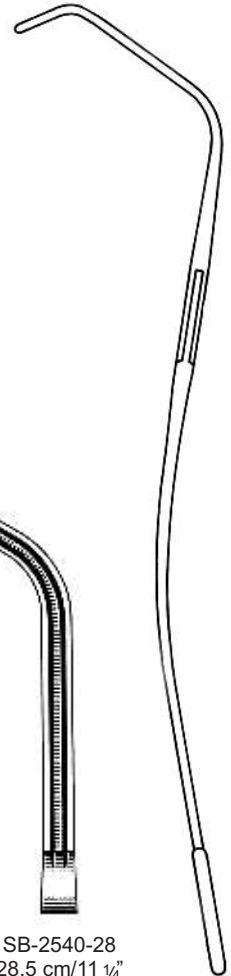

Cardiovascular Instruments

Bronchus Clamps
bronchus-Schellen

Pincas bronches
Abrazaderas de bronquios

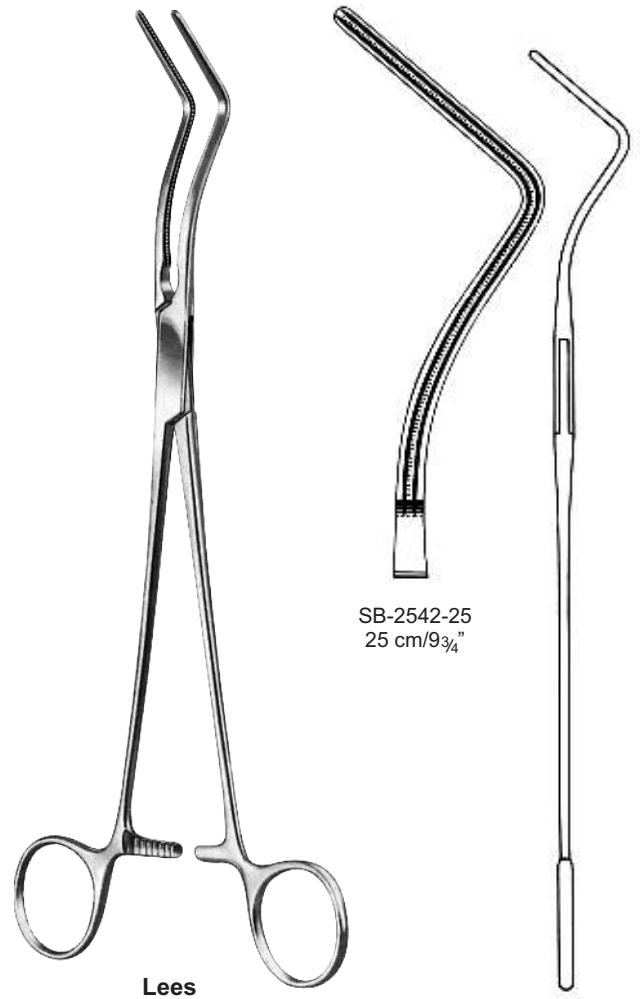
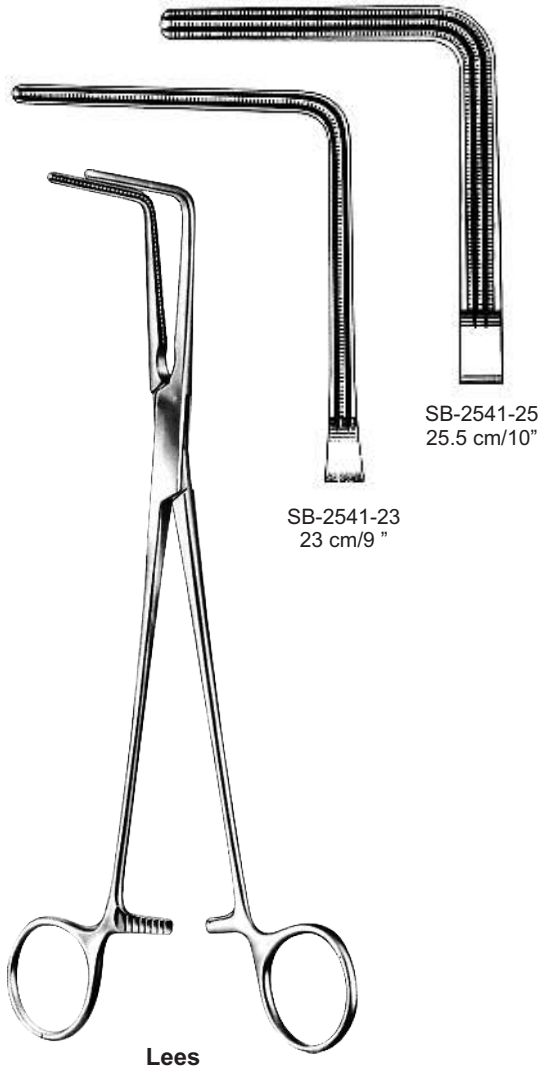

Cardiovascular Instruments

Aortic Clamps
Aorten-Schellen

clamps aortiques
Abrazaderas aórticas

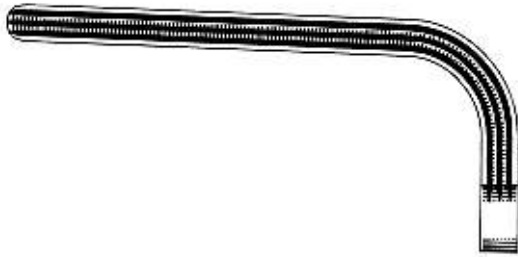

SB-2543-16
16.5 cm/6 1/2"

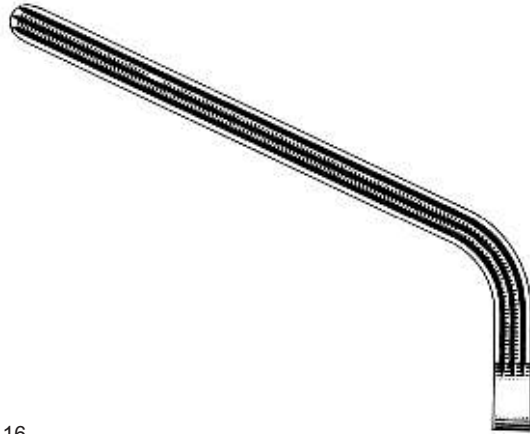

SB-2543-20
20 cm/8 "



Morris-DeBakey

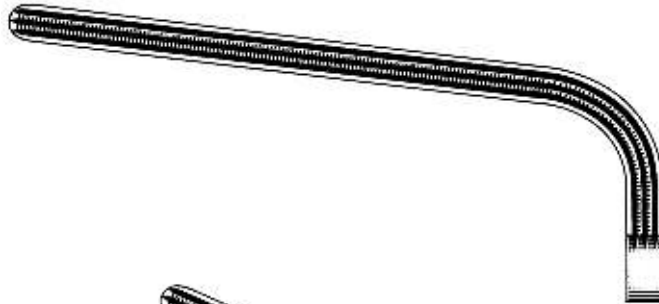

SB-2543-24
24 cm/9 1/2"

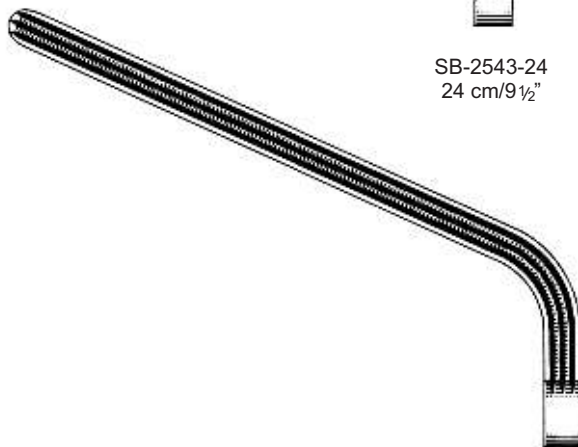

SB-2543-26
26 cm/10 1/4"

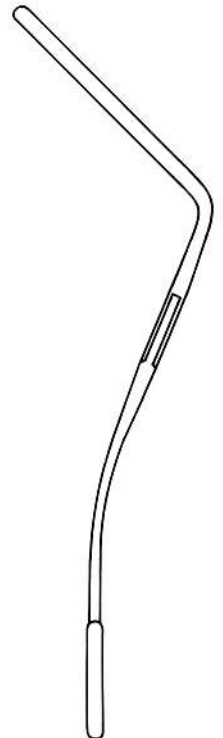

Cardiovascular Instruments

Anastomosis Clamps
Anastomose Schellen

Pincas anastomose
Abrazaderas anastomosis



Morris-DeBakey



SB-2544-22
22.5 cm/8 3/4"

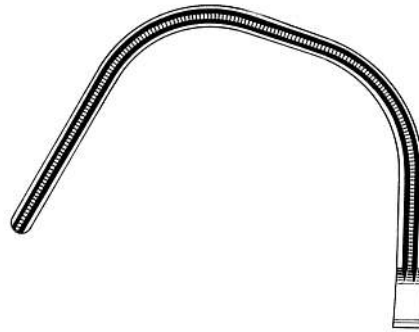

SB-2544-22
22.5 cm/8 3/4"

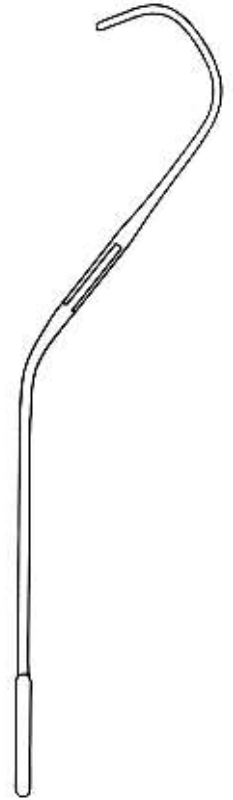

DeBakey

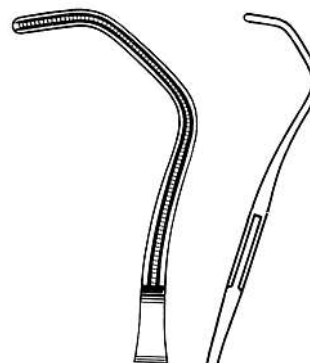

SB-2545-16
16.5 cm/6 1/2"



Cardiovascular Instruments

Aneurysm Clamps
Aneurysma Schellen

Pinces anévrisme
Abrazaderas Aneurisma



DeBakey-Bahnson

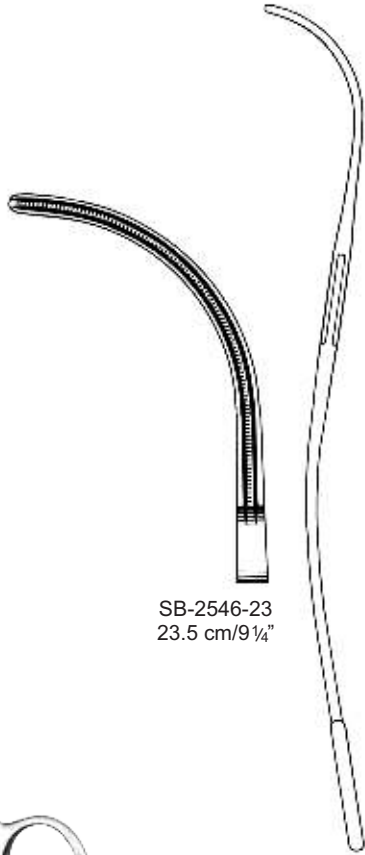

SB-2546-23
23.5 cm/9 1/4"

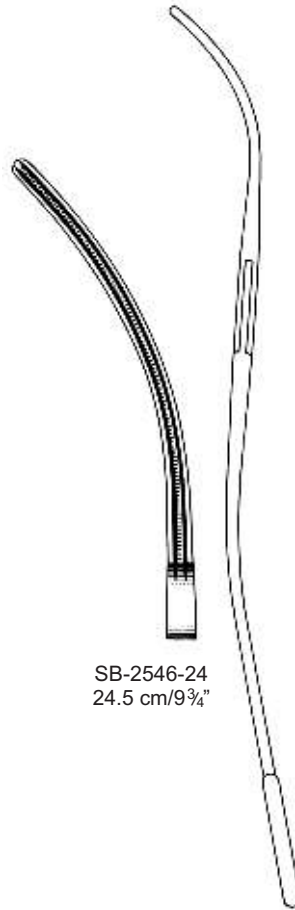

SB-2546-24
24.5 cm/9 3/4"

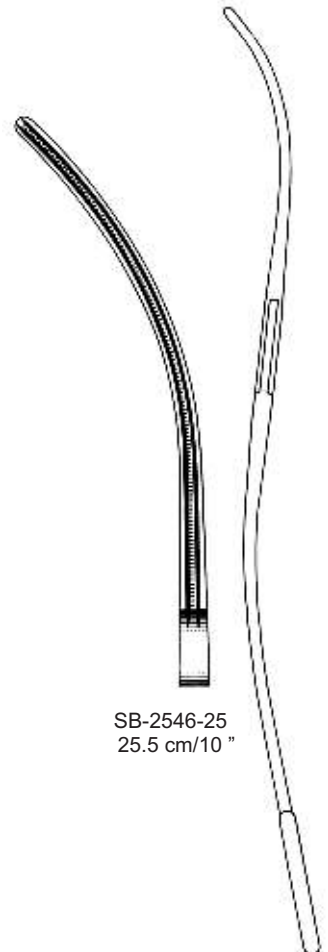

SB-2546-25
25.5 cm/10 "

Cardiovascular Instruments

Multi purpose Vascular Clamps
Mehrzweck Gefäßklemmen

Pinces multi usages vasculaires
Abrazaderas multipropósito vasculares

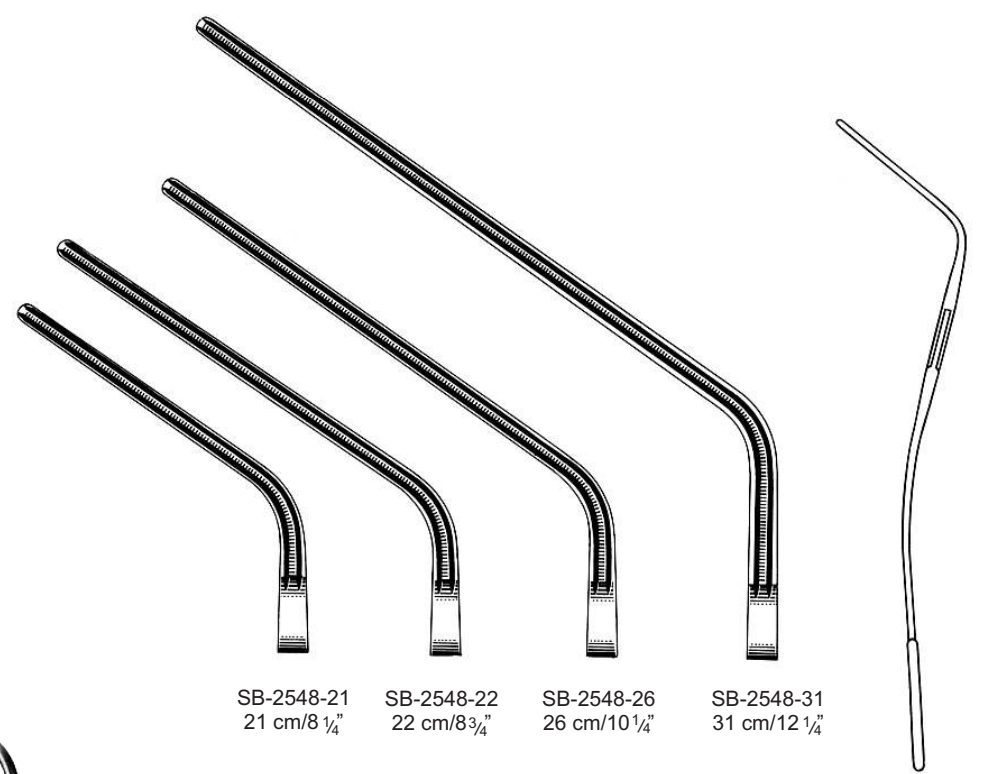
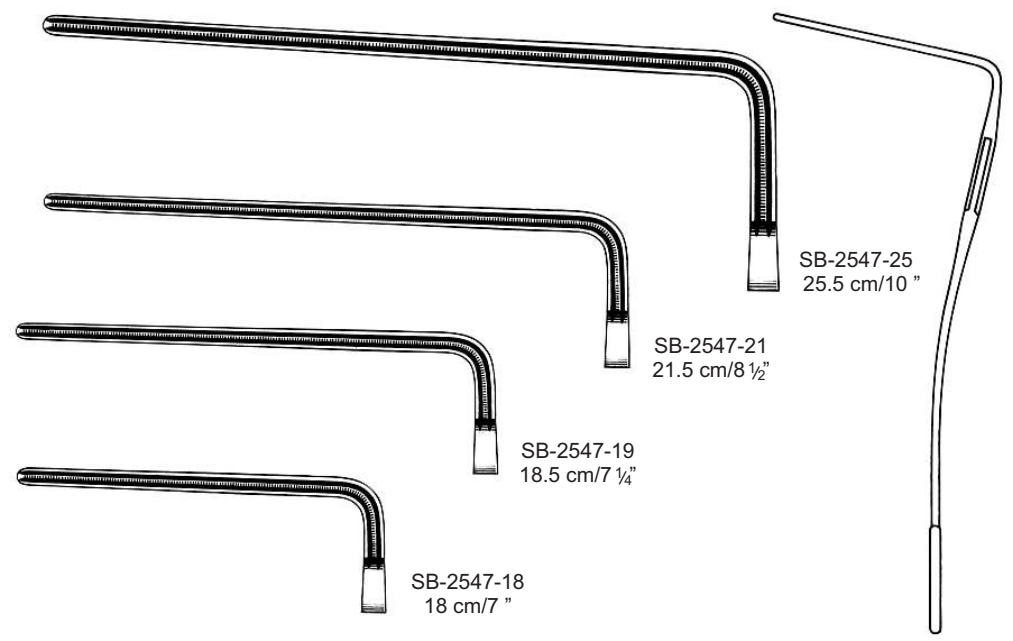

Cardiovascular Instruments

Multi purpose Vascular Clamps
Mehrzweck Gefäßklemmen

Pinces multi usages vasculaires
Abrazaderas multipropósito vasculares



Potts



SB-2549-21
21.5 cm/8½"



SB-2549-23
23.5 cm/9¼"



SB-2549-27
27 cm/9¾"



SB-2549-31
31 cm/12¼"



SB-2550-21
21 cm/8¼"



SB-2550-23
23 cm/9"



SB-2550-26
26 cm/9¼"



SB-2550-30
30.5 cm/12"

Cardiovascular Instruments

Haemosttic Forceps
Haemoststic Zange

Pince Haemoststic
Pinzas Haemoststic



DeBakey-Pean



SB-2551-14
14.5 cm/5 3/4"



SB-2551-16
16.5 cm/5 1/4"



SB-2551-18
18.5 cm/7 1/4"



SB-2551-20
20.5 cm/8 "



DeBakey-Pean



SB-2552-14
14.5 cm/5 3/4"



SB-2552-16
16.5 cm/5 1/4"



SB-2552-18
18.5 cm/7 1/4"



SB-2552-20
20.5 cm/8 "

Cardiovascular Instruments

Multi purpose Vascular Clamps
Mehrzweck Gefäßklemmen

Pinces multi usages vasculaires
Abrazaderas multipropósito vasculares

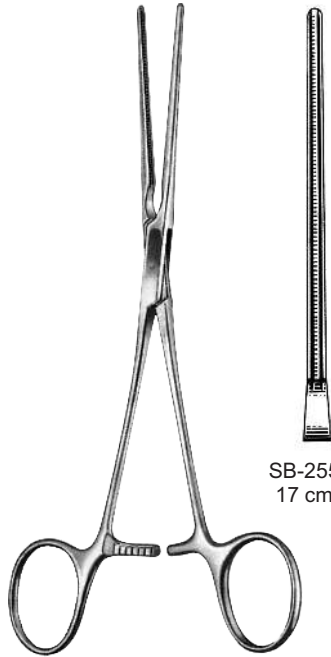

SB-2553-17
17 cm / 7 3/4"

DeBakey

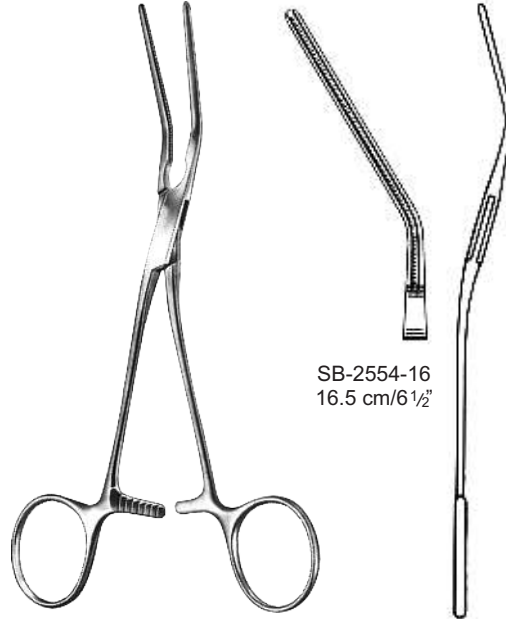

SB-2554-16
16.5 cm / 6 1/2"

DeBakey

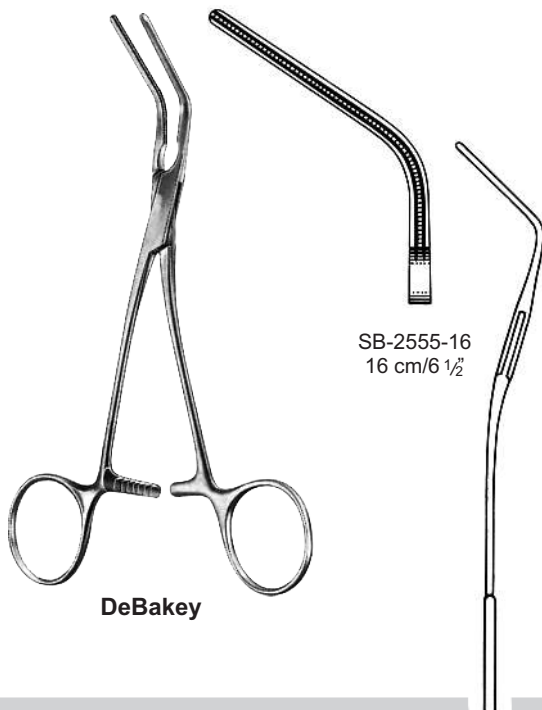

SB-2555-16
16 cm / 6 1/2"

DeBakey



SB-2556-14
14.5 cm / 5 3/4"

DeBakey

Cardiovascular Instruments

Multi purpose Vascular Clamps
Mehrzweck Gefäßklemmen

Pinces multi usages vasculaires
Abrazaderas multipropósito vasculares

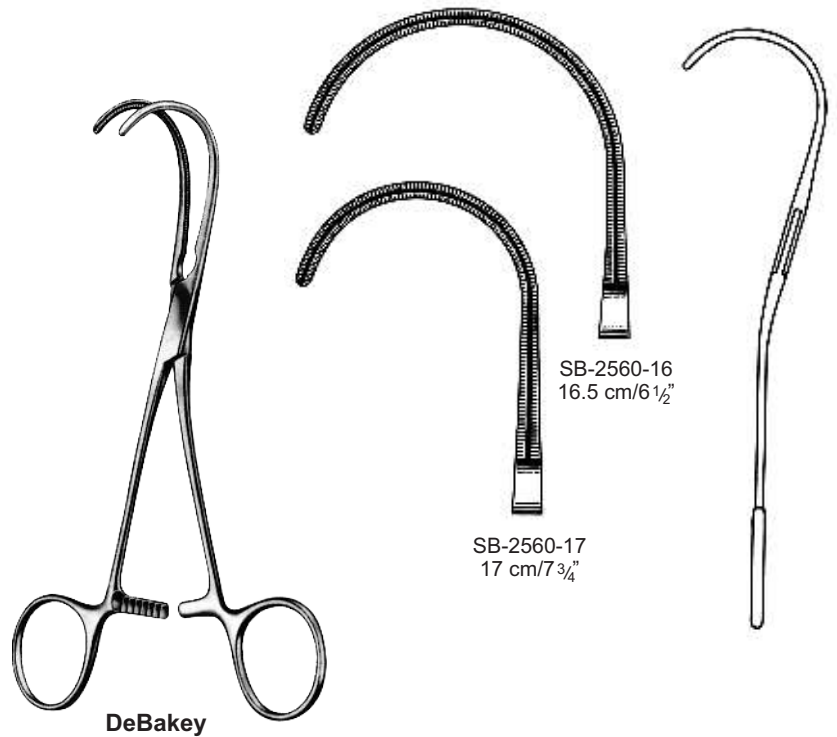
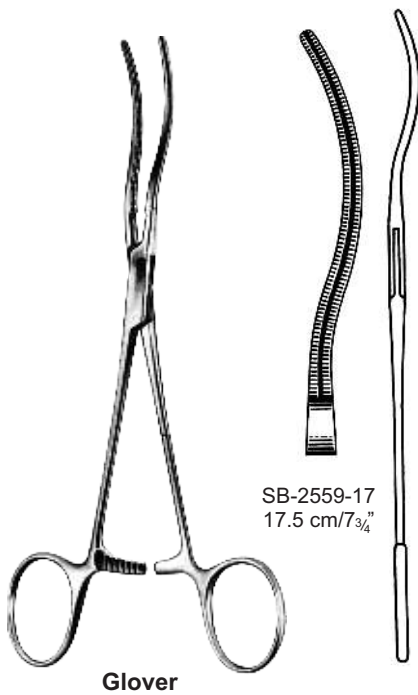
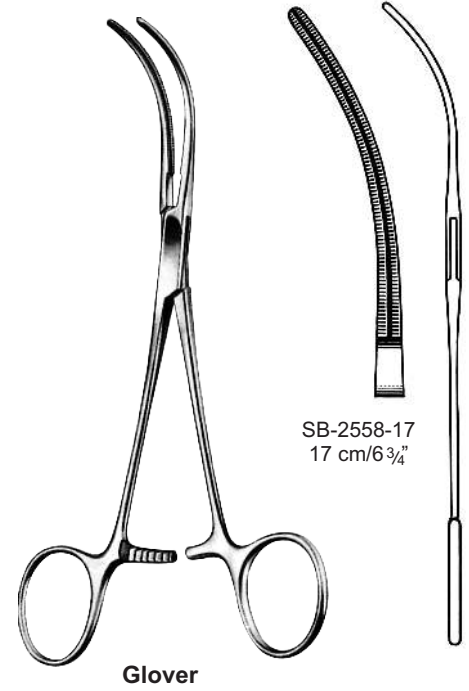
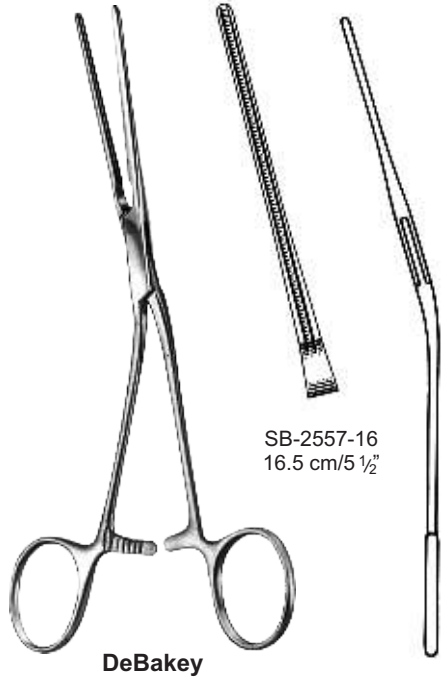

Cardiovascular Instruments

Anastomosis Clamps and Pediatric Vascular Clamps
Anastomose Klemmen und Pädiatrische Gefäßklemmen

Pinces anastomose et pédiatriques clamps vasculaires
Abrazaderas de anastomosis y pediátricos pinzas vasculares

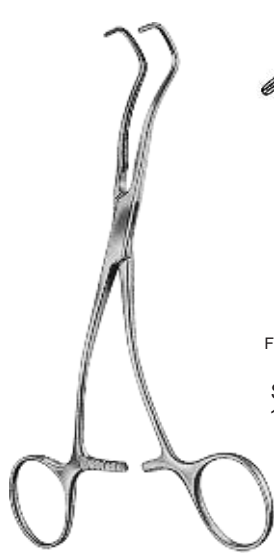

Derra

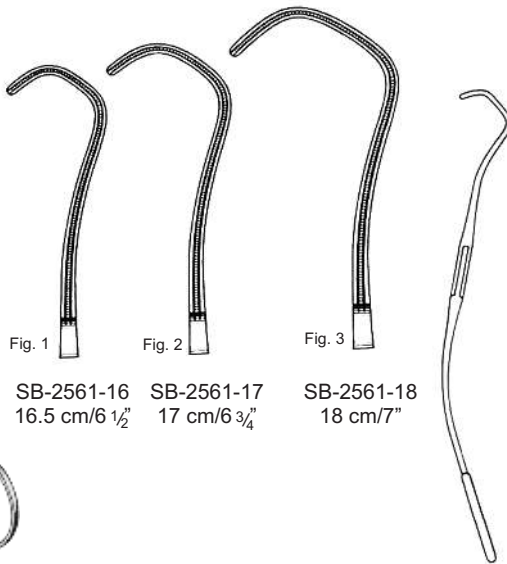

Fig. 1

Fig. 2

Fig. 3

SB-2561-16
16.5 cm/6 1/2"

SB-2561-17
17 cm/6 3/4"

SB-2561-18
18 cm/7"



DeBakey-Beck



SB-2562-17
17 cm/6 3/4"



DeBakey

SB-2563-10
10 cm/4"

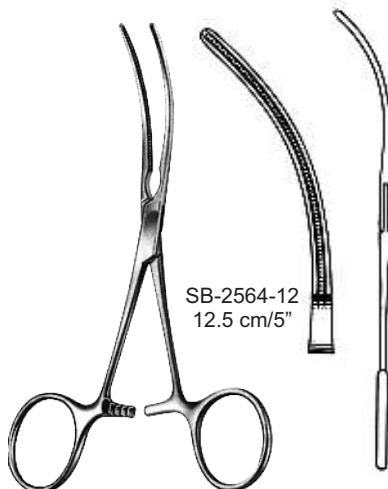

DeBakey

SB-2564-12
12.5 cm/5"



SB-2565-12
12 cm/5"

Cardiovascular Instruments

Pediatric Vascular Clamps
Pediatric Gefäßsklemmen

Pédiatriques clamps vasculaires
Pediátricos pinzas vasculares



DeBakey



SB-2566-12
12.5 cm/5"



DeBakey

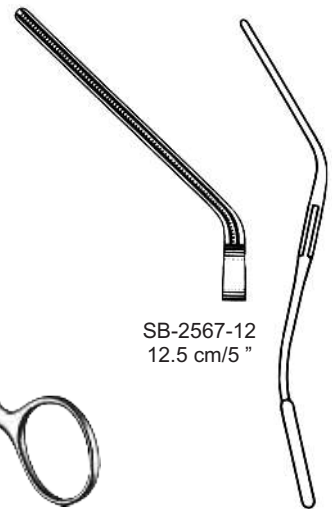

SB-2567-12
12.5 cm/5"

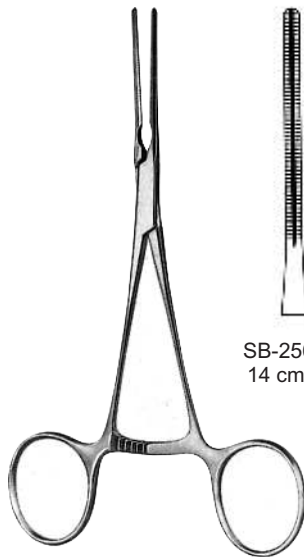

DeBakey

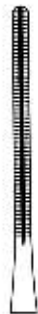

SB-2568-01
14 cm/5 1/2"



SB-2568-02
12.5 cm/5 3/4"



DeBakey



SB-2569-03
12.5 cm/5 1/2"

Cardiovascular Instruments

Pediatric Vascular and Anastomosis Clamps
Pediatric Vascular Anastomose und Schellen

Vasculaire pédiatrique et pinces Anastomose
Vascular pediátrica y abrazaderas Anastomosis



SB-2570-14
14 cm/5 1/2"

Cooley

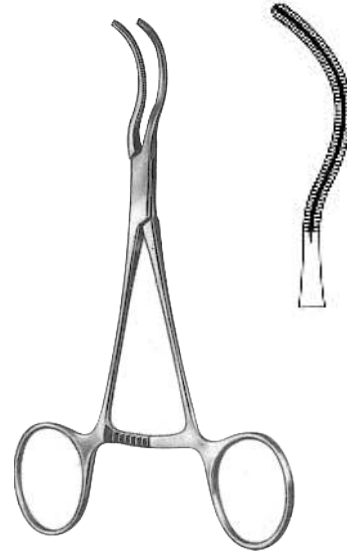

Cooley
SB-2571-14
14 cm/5 1/2"

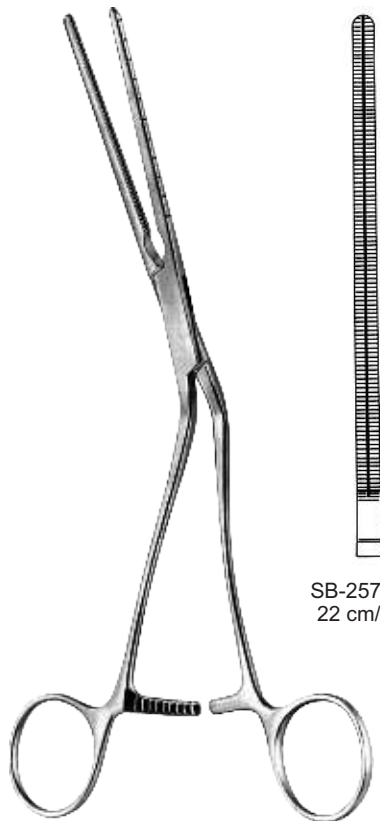

SB-2572-22
22 cm/8 3/4"

Cooley
Iliac Clamp

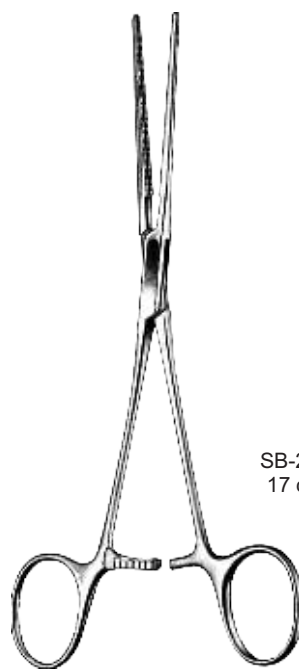

SB-2573-17
17 cm/6 3/4"

Cooley

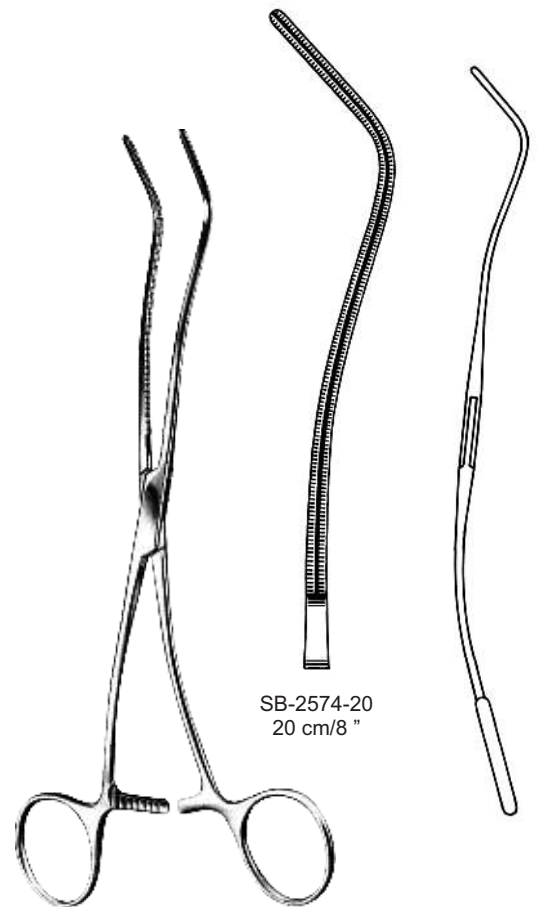

SB-2574-20
20 cm/8 "

Cooley

Cardiovascular Instruments

Anastomosis Clamps, Multi purpose Vascular Clamps
Anastomose Klemmen, Mehrzweck Gefäßklemmen

Pincas Anastomose, colliers multi usages vasculaires
Abrazaderas, Abrazaderas anastomosis vasculares multipropósito



Cooley

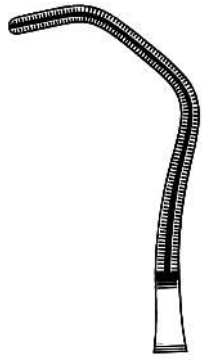

SB-2575-16
16cm/6 1/4"



Cooley



SB-2576-16
16cm/5 1/4"

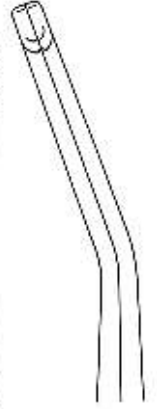

Cooley

SB-2577-14
14cm/5 1/2"

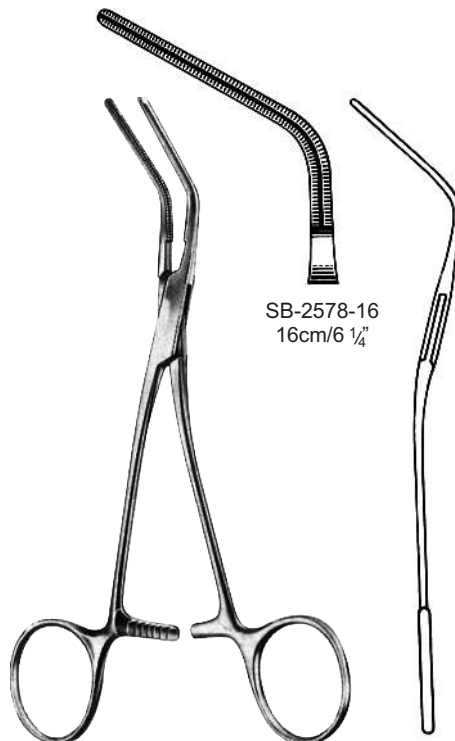

Cooley

SB-2578-16
16cm/6 1/4"

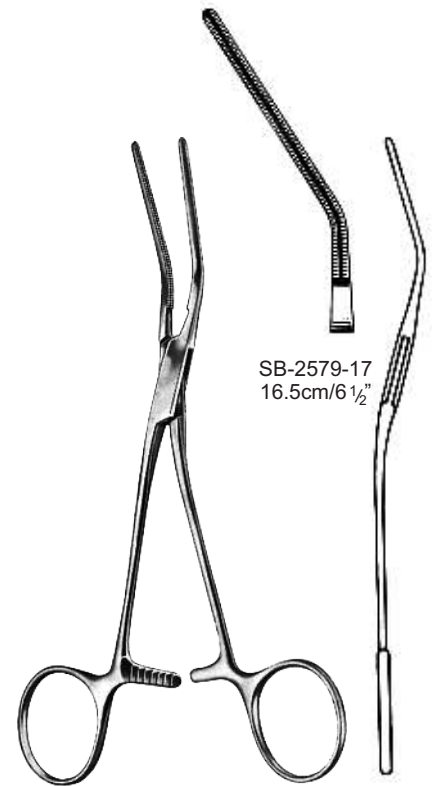

Cooley

SB-2579-17
16.5cm/6 1/2"

Cardiovascular Instruments

Multi Purpose vascular Clamps
Multi Purpose Gefäßklemmen

Pinces Multi Purpose vasculaires
Pinzas Multiuso vasculares

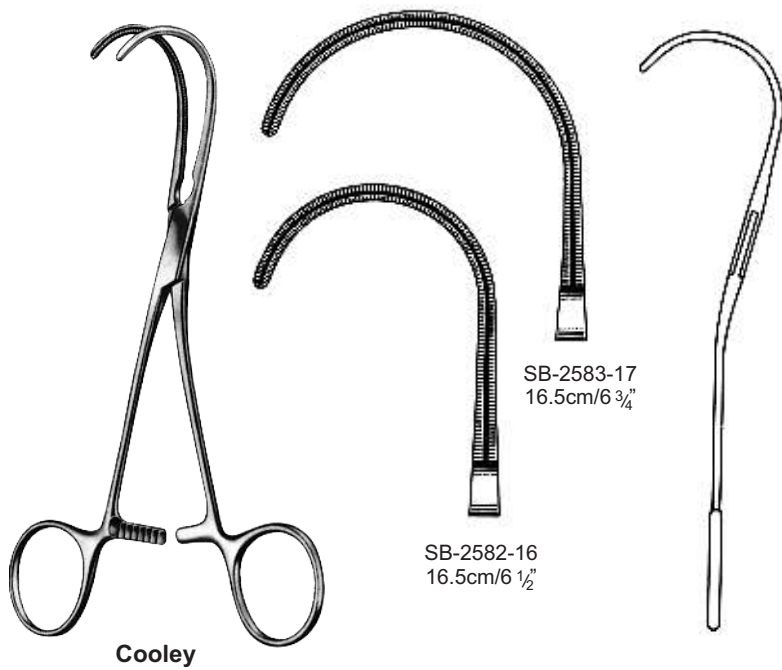
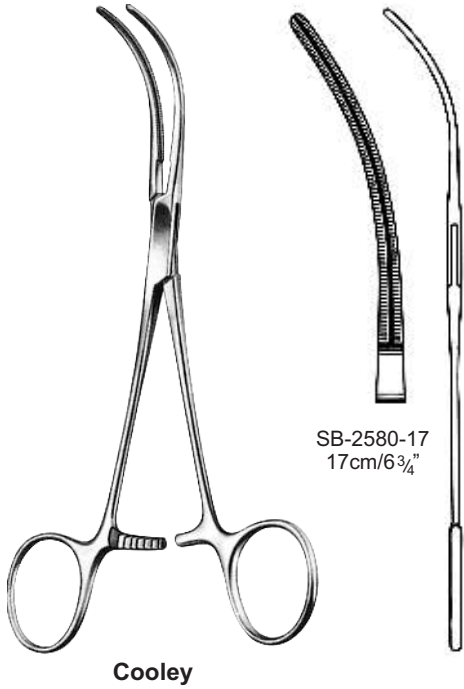

SB-2583-17
16.5cm/6¾"

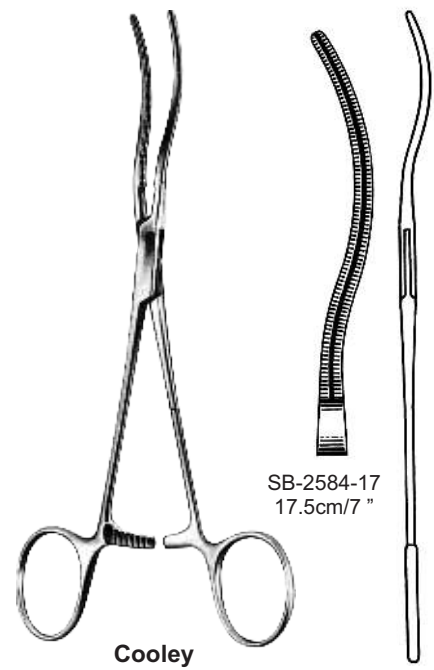

Cardiovascular Instruments

Multi Purpose vascular Clamps
Multi Purpose Gefäßklemmen

Pinces Multi Purpose vasculaires
Pinzas Multiuso vasculares



SB-2585-16
16.5cm/7 1/2"

DeBakey



SB-2586-16
16cm/7 1/4"

DeBakey

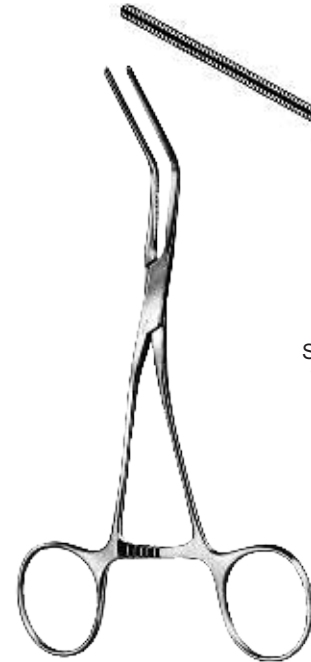

SB-2587-16
15.5cm/6"

DeBakey



Cooley

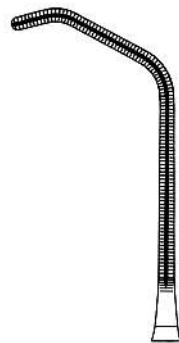

SB-2588-16
15.5cm/6"



Cooley

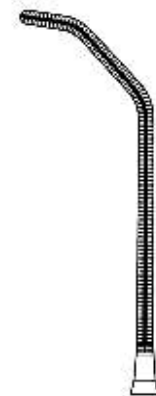

SB-2589-16
16cm/6"

Cardiovascular Instruments

Neonatal and Pediatric Clamps
Neonatologischen und pädiatrischen Schellen

Pinces néonatale et pédiatrique
Abrazaderas neonatal y pediátrica

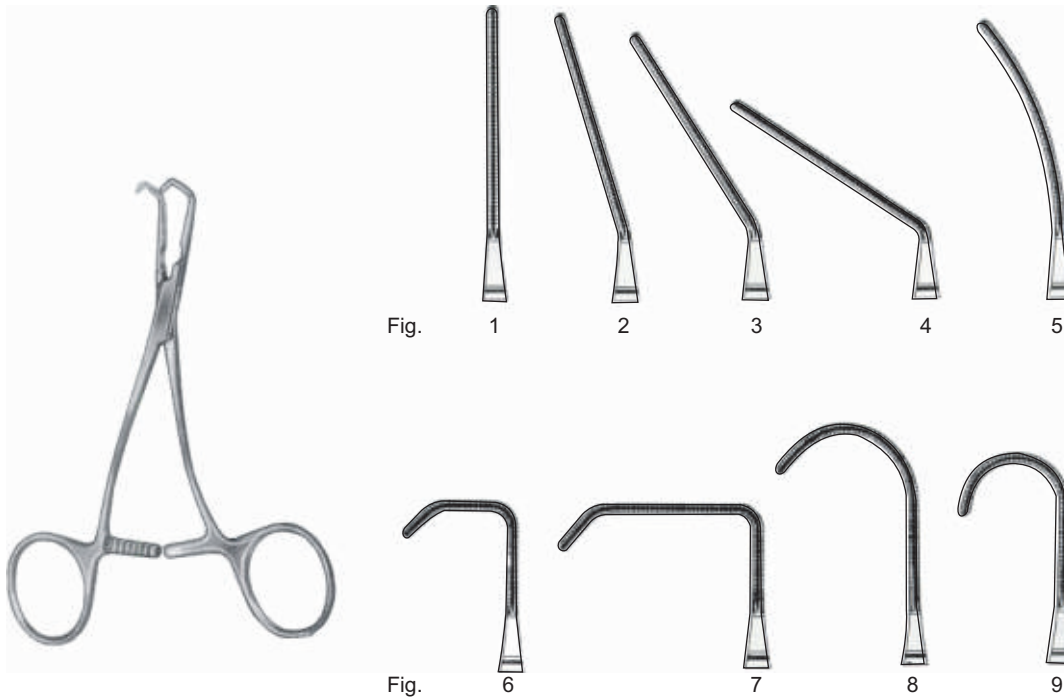

| Fig. | Straight gerade droit recto |
|------|--------------------------------------|
| 1 | SB-2590-01 |
| 2 | SB-2590-02 |
| 3 | SB-2590-03 |
| 4 | SB-2590-04 |
| 5 | SB-2590-05 |
| 6 | SB-2590-06 |
| 7 | SB-2590-07 |
| 8 | SB-2590-08 |
| 9 | SB-2590-09 |

| Fig. | Angled Anglé incliné angular |
|------|---------------------------------------|
| 1 | SB-2591-01 |
| 2 | SB-2591-02 |
| 3 | SB-2591-03 |
| 4 | SB-2591-04 |
| 5 | SB-2591-05 |
| 6 | SB-2591-06 |
| 7 | SB-2591-07 |
| 8 | SB-2591-08 |
| 9 | SB-2591-09 |

| Fig. | Curved Gebogene courbé Curvo |
|------|---------------------------------------|
| 1 | SB-2592-01 |
| 2 | SB-2592-02 |
| 3 | SB-2592-03 |
| 4 | SB-2592-04 |
| 5 | SB-2592-05 |
| 6 | SB-2592-06 |
| 7 | SB-2592-07 |
| 8 | SB-2592-08 |
| 9 | SB-2592-09 |

Cardiovascular Instruments

Neonatal Vascular Clamps
Neonatal Gefäßklemmen

Néonatales clamps vasculaires
Neonatales pinzas vasculares



Castaneda



SB-2593-01
12cm/5"



SB-2593-02
11.5cm/4½"

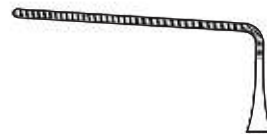

SB-2593-03
11cm/4¼"

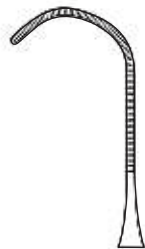

SB-2594-01
11.5cm/4½"

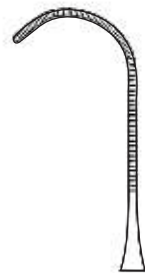

SB-2594-02
12cm/4¾"



SB-2594-03
12cm/4¾"



SB-2594-04
12cm/4¾"

Cardiovascular Instruments

Intima Spatula, Vascular Dissectors
Lingerie Spachtel-, Gefäß-Dissektoren

Spatule intime, dissecteurs vasculaires
Intima Spatula, Vascular disector

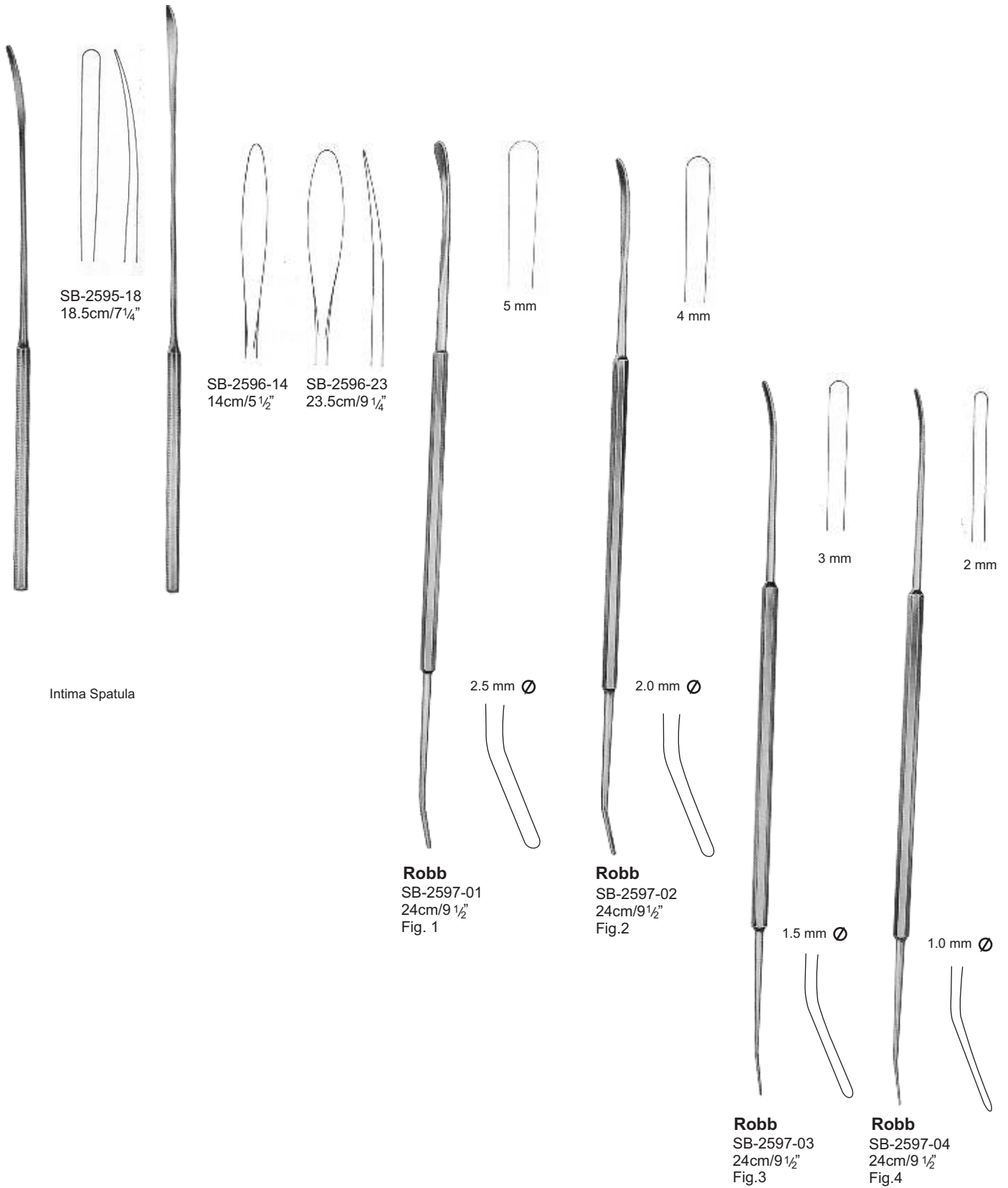

Cardiovascular Instruments

Nerve Hooklets, Toruniqetes
Nerve Hakchen, Toruniqetes

Petits crochets nerveuses, Toruniqetes
Ganchillos nerviosas, Toruniqetes



SB-2598-20
20cm/8"

Crile



SB-2599-20
20.5cm/8"

Crile



Ligature Catchers



SB-2600-01
26cm/10 1/4"
1.5 mm



SB-2600-02
26cm/10 1/4"
2.0 mm



SB-2600-03
26cm/10 1/4"
2.5 mm



SB-2600-04
26cm/10 1/4"
3.0 mm



SB-2601-27
26cm/10 3/4"
3.0 mm ϕ

SB-2601-30
30.5cm/12"
6.4 mm ϕ

Rumel-Belmont

Cardiovascular Instruments

Aortic Dilators
Aorten-Dilatatoren

Dilatateurs aortiques
dilataadores aórticos

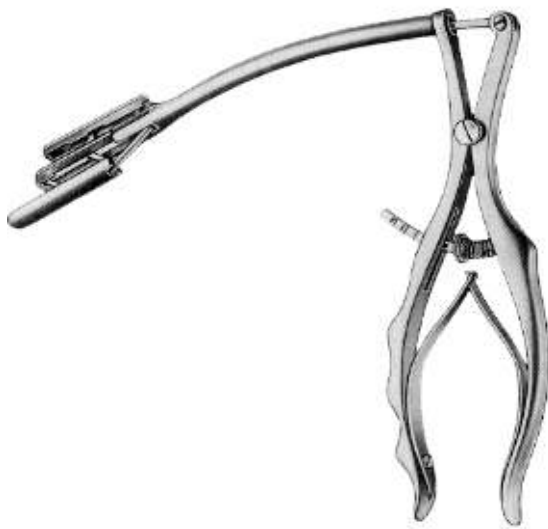

Cooley
SB-2602-00



Gerbode
SB-2603-00

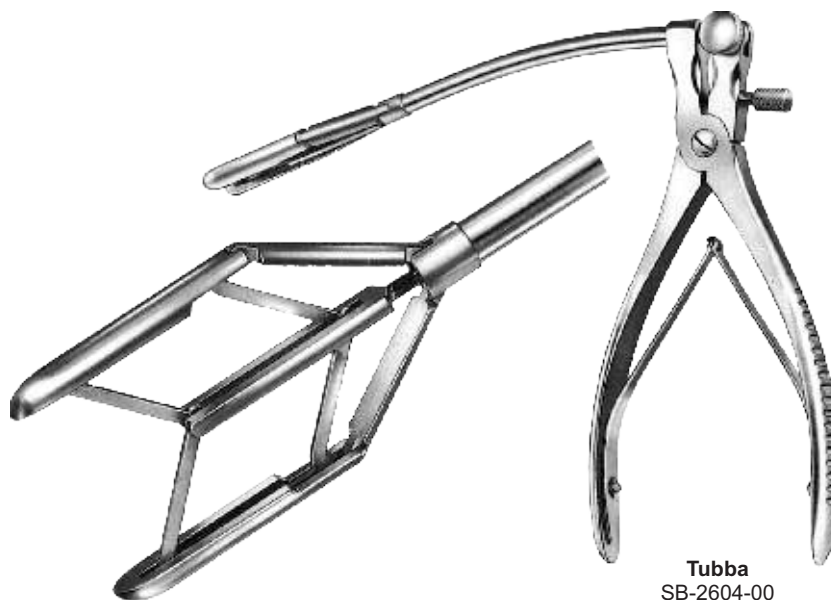

Tubba
SB-2604-00



Serving Health Care

SPEED BIRD

ENTERPRISES



**161/C, SMALL INDUSTRIAL ESTATE
SIALKOT-51310, (PAKISTAN)**



: +92-304 0549944



: +92-52-3555584



: speed@birddent.com



: www.birddent.com