



*Serving Health Care*

**SPEED BIRD**  
ENTERPRISES

[www.birddent.com](http://www.birddent.com)

**BONE INSTRUMENTS**

**SECTION**

**12**

## Bone Instruments

Plaster Knives, Saw and Cast Breakers  
Gips Messer, Säge-und Cast Breakers

Breakers Couteaux plâtre, de sciage et de Cast  
Cuchillos de yeso, de sierra y el Elenco Breakers



**Hopkins**  
SB -1828-20  
20 cm/8"



**Esmarch**  
SB -1829-18  
18 cm/7"



**Reiner**  
SB -1830-18  
18.5 cm/7¼"

Plaster Saw  
Gipssäge  
plâtre de scie  
yeso Saw



**Engel**  
SB -1831-14  
14cm/5½"

## Bone Instruments

Plaster Spreaders  
Gips Spreizer

Ebandage de plâtre  
Separadores de yeso



**Hennig**  
SB -1832-28  
28 cm/11"

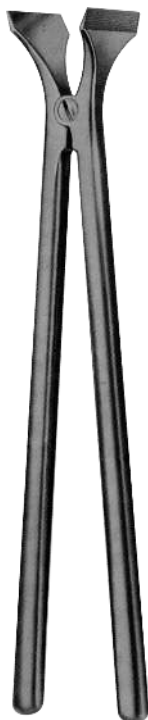

**Beeson**  
SB -1833-30  
30 cm/12"



**Haglund-Stille**  
SB -1834-28  
28 cm/11"



**Mod. USA**  
SB -1835-23  
23 cm/9"

## Bone Instruments

Plaster Instruments  
Gips Instruments

Instruments de plâtre  
Instrumentos de yeso



**Wolf**  
SB -1836-18 18cm/7"  
SB -1836-24 24cm/9½"



**Stille**  
SB -1837-24  
24cm/9½"



**Stille**  
SB-183 8-23 23cm/9"  
SB-183 8-26 26cm/9¼"  
SB-183 8-37 37cm/14½"

# Bone Instruments

Bone Chisels & Gouges  
Knochenmeißeln & Gouges

Bone ciseaux et gouges  
Cinceles y Gouges

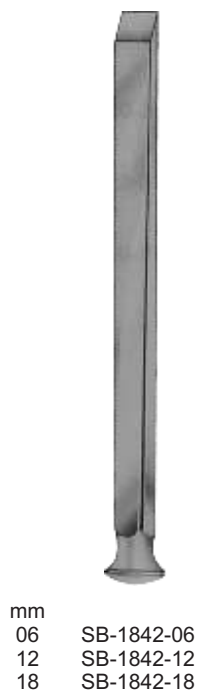
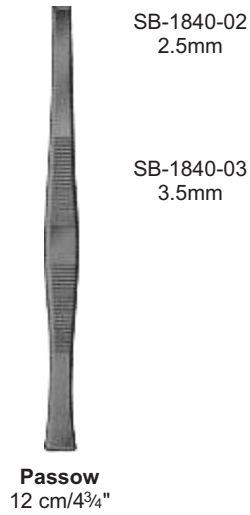
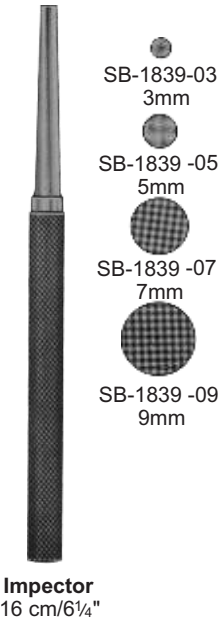

## Bone Instruments

Bone Chisels, Gouges and Osteotomes  
Knochenmeißeln, Gouges und Osteotome

Bone ciseaux, gouges et ostéotomes  
Cinceles, formones y osteotomos



Width  
Breite  
largeur  
ancho

mm			
04	SB-1845-04	SB-1846-04	SB-1847-04
06	SB-1845-06	SB-1846-06	SB-1847-06
08	SB-1845-08	SB-1846-08	SB-1847-08
10	SB-1845-10	SB-1846-10	SB-1847-10
12	SB-1845-12	SB-1846-12	SB-1847-12
14	SB-1845-14	SB-1846-14	SB-1847-14
16	SB-1845-16	SB-1846-16	SB-1847-16
	13.5 cm/5 1/4"		



mm	Partsch	
02	SB-1848-02	SB-1849-02
03	SB-1848-03	SB-1849-03
04	SB-1848-04	SB-1849-04
05	SB-1848-05	SB-1849-05
06	SB-1848-06	SB-1849-06
07	SB-1848-07	SB-1849-07
08	SB-1848-08	SB-1849-08
	13.5 cm/5 1/4"	17 cm/6 3/4"



	Partsch	
	SB-1850-02	SB-1851-04
	SB-1850-03	SB-1851-06
	SB-1850-04	SB-1851-08
	SB-1850-05	SB-1851-10
	SB-1850-06	SB-1851-12
	SB-1850-07	SB-1851-14
	SB-1850-08	SB-1851-16
	13.5 cm/5 1/4"	17 cm/6 3/4"

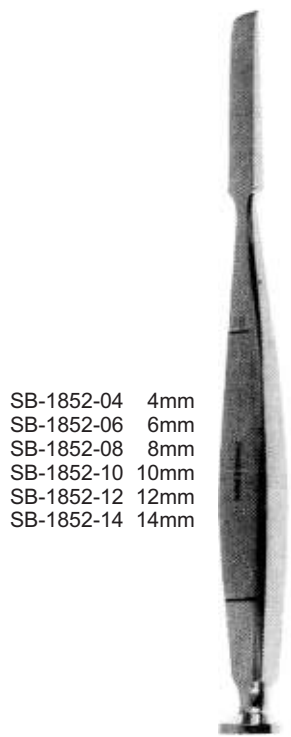

SB-1852-04	4mm
SB-1852-06	6mm
SB-1852-08	8mm
SB-1852-10	10mm
SB-1852-12	12mm
SB-1852-14	14mm

**Poirioer**  
16cm/6 "



SB-1853-02	2mm
SB-1853-04	4mm
SB-1853-06	6mm
SB-1853-08	8mm
SB-1853-10	10mm
SB-1853-12	12mm
SB-1853-14	14mm

**Poirioer**  
16cm/6 "



SB-1854-04	4mm
SB-1854-06	6mm
SB-1854-08	8mm
SB-1854-10	10mm
SB-1854-12	12mm
SB-1854-14	14mm

**Proirier Triuat**  
20cm/8"







## Bone Instruments

Bone Chisels, Gouges and Osteotomes  
Knochenmeißeln, Gouges und Osteotome

Bone ciseaux, gouges et ostéotomes  
Cinceles, formones y osteotomos









**Hautant**  
13 cm/5"

-  SB-1855-02 2 mm
-  SB-1855-04 4 mm
-  SB-1855-05 5 mm
-  SB-1855-06 6 mm
-  SB-1855-08 8 mm
-  SB-1855-10 10mm
-  SB-1855-12 12mm











**Judet**  
22 cm/8¾"

-  SB-1856-10 10mm
-  SB-1856-15 15mm
-  SB-1856-20 20mm
-  SB-1856-25 25mm
-  SB-1856-30 30mm
-  SB-1856-35 35mm









**Cauchoix**  
25 cm/10"

-  SB-1857-08 8 mm
-  SB-1857-10 10mm
-  SB-1857-12 12mm
-  SB-1857-14 14mm
-  SB-1857-16 16mm
-  SB-1857-18 18mm
-  SB-1857-20 20mm
-  SB-1857-25 25mm



**Cauchoix**  
25 cm/10"

-  SB-1858-16 16mm
-  SB-1858-18 18mm
-  SB-1858-20 20mm
-  SB-1859-16 16mm
-  SB-1859-18 18mm
-  SB-1859-20 20mm

## Bone Instruments

Bone Chisels, Gouges and Osteotomes  
Knochenmeißeln, Gouges und Osteotome

Bone ciseaux, gouges et ostéotomes  
Cinceles, formones y osteotomos



**Farabeuf**  
21 cm/8 $\frac{1}{4}$ "

- SB-1860-10 10mm
- SB-1860-15 15mm
- SB-1860-20 20mm
- SB-1860-25 25mm
- SB-1860-30 30mm



**Farabeuf**  
25 cm/10"

- SB-1861-06 6mm
- SB-1861-08 8mm
- SB-1861-10 10mm
- SB-1861-12 12mm

- SB-1861-15 15mm
- SB-1861-20 20mm
- SB-1861-25 25mm
- SB-1861-30 30mm



**Maceven**  
20 cm/8"

- SB-1862-10 10mm
- SB-1862-15 15mm
- SB-1862-20 20mm



# Bone Instruments

Bone Chisels, and Gouges  
Knochenmeißeln, und Gouges

Bone ciseaux, et gouges  
Cinceles, formones y



**Lexer**  
27.5 cm/10¾"

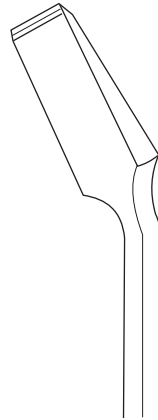
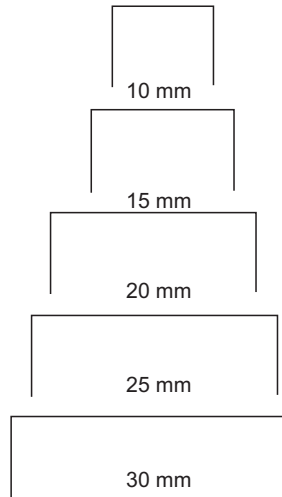

SB-1863-10  
SB-1863-15  
SB-1863-20  
SB-1863-25  
SB-1863-30

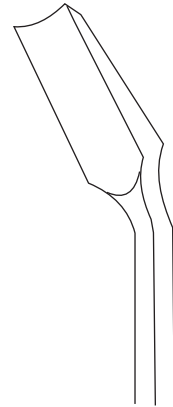

SB-1864-10  
SB-1864-15  
SB-1864-20  
SB-1864-25  
SB-1864-30



**Alexander**  
18 cm/7"

- SB-1865-04
- SB-1865-06
- SB-1865-08
- SB-1865-10
- SB-1865-12
- SB-1865-14

- mm
- 04
- 06
- 08
- 10
- 12
- 14



- SB-1866-04
- SB-1866-06
- SB-1866-08
- SB-1866-10
- SB-1866-12
- SB-1866-14

## Bone Instruments

Bone Chisels, and Gouges Osteotomes      Bone ciseaux, et gouges ostéotomes  
Knochenmeißeln, und Gouges Osteotome      Cinceles, formones y osteotomos

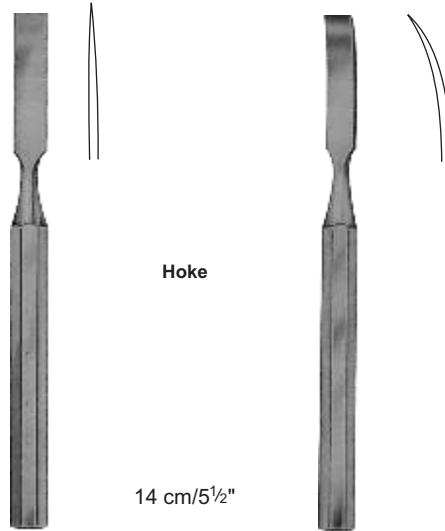

	mm	
SB-1867-02	2	SB-1868-02
SB-1867-03	3	SB-1868-03
SB-1867-04	4	SB-1868-04
SB-1867-05	5	SB-1868-05
SB-1867-06	6	SB-1868-06
SB-1867-07	7	SB-1868-07
SB-1867-08	8	SB-1868-08



**Smith-Petersen**  
20 cm/8"



mm				
06	SB-1869-06	SB-1870-06	SB-1871-06	SB-1872-06
09	SB-1869-09	SB-1870-09	SB-1871-09	SB-1872-09
13	SB-1869-13	SB-1870-13		
14			SB-1871-14	SB-1872-14
16	SB-1869-16	SB-1870-16	SB-1871-16	SB-1872-16
19	SB-1869-19	SB-1870-19	SB-1871-19	SB-1872-19
25	SB-1869-25	SB-1870-25	SB-1871-25	SB-1872-25
32	SB-1869-32	SB-1870-32	SB-1871-32	SB-1872-32

# Bone Instruments

Bone Chisels, and Gouges Osteotomes      Bone ciseaux, et gouges ostéotomes  
Knochenmeißeln, und Gouges Osteotome      Cinceles, formones y osteotomos



**Lambotte**  
mm

SB-1873-04	04	SB-1874-04
SB-1873-06	06	SB-1874-06
SB-1873-08	08	SB-1874-08
SB-1873-10	10	SB-1874-10
SB-1873-13	13	SB-1874-13
SB-1873-16	16	SB-1874-16
SB-1873-18	18	SB-1874-18
SB-1873-20	20	SB-1874-20
SB-1873-25	25	SB-1874-25
SB-1873-30	30	SB-1874-30
SB-1873-38	38	SB-1874-38
SB-1873-44	44	SB-1874-44
SB-1873-50	50	SB-1874-50
24 cm/9½"		23 cm/9"

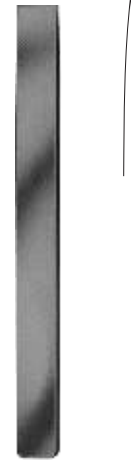

**Mini-Lambotte**  
mm

SB-1875-02	02	SB-1876-02
SB-1875-03	03	SB-1876-03
SB-1875-04	04	SB-1876-04
SB-1875-06	06	SB-1876-06
SB-1875-08	08	SB-1876-08
SB-1875-10	10	SB-1876-10
SB-1875-12	12	SB-1876-12
SB-1875-15	15	SB-1876-15
12.5 cm/5"		17 cm/6¾"



**Mini-Lexer**  
mm

SB-1877-04	04	SB-1878-04
SB-1877-06	06	SB-1878-06
SB-1877-08	08	SB-1878-08
SB-1877-10	10	SB-1878-10
SB-1877-12	12	SB-1878-12
18 cm/7"		



**Lexer**  
mm

SB-1879-05	05	SB-1880-05
SB-1879-07	07	SB-1880-07
SB-1879-10	10	SB-1880-10
SB-1879-15	15	SB-1880-15
SB-1879-20	20	SB-1880-20
SB-1879-25	25	SB-1880-25
SB-1879-30	30	SB-1880-30
22 cm/8¾"		



## Bone Instruments

Bone Chisels, and Gouges  
Knochenmeißeln, und Gouges

Bone ciseaux, et gouges  
Cinceles, formones y



**Chisel**  
SB-1881-20  
24.5 cm/9¾"  
20 mm



**Chisel-Curved**  
SB-1882-20  
26.5 cm/10½"  
20 mm

Gouge for the removing of  
broken screws  
Hohlmeißel für das Entfernen von  
abgebrochener Schrauben  
Gouge pour la suppression de vis cassées  
Gubia para la remoción de tornillos rotos



SB-1883-22  
22 cm/8¾"

# Bone Instruments

Bone Chisels, and Gouges Osteotomes      Bone ciseaux, et gouges ostéotomes  
Knochenmeißeln, und Gouges Osteotome      Cinceles, formones y osteotomos



**Zielke**  
23 cm/9"  
5.5 mm  
9.0 mm  
SB-1884-05  
SB-1884-09

Width  
Breite  
largeur  
ancho



mm	SB-1884-06	SB-1885-06	SB-1886-06	SB-1887-06	SB-1888-06
06	SB-1884-06	SB-1885-06	SB-1886-06	SB-1887-06	SB-1888-06
08	SB-1884-08	SB-1885-08	SB-1886-08	SB-1887-08	SB-1888-08
10	SB-1884-10	SB-1885-10	SB-1886-10	SB-1887-10	SB-1888-10
12	SB-1884-12	SB-1885-12	SB-1886-12	SB-1887-12	SB-1888-12
15	SB-1884-15	SB-1885-15	SB-1886-15	SB-1887-15	SB-1888-15
20	SB-1884-20	SB-1885-20	SB-1886-20	SB-1887-20	SB-1888-20
25	SB-1884-25	SB-1885-25	SB-1886-25	SB-1887-25	SB-1888-25
30	SB-1884-30	SB-1885-30	SB-1886-30	SB-1887-30	SB-1888-30

**Stille**  
20 cm/8"

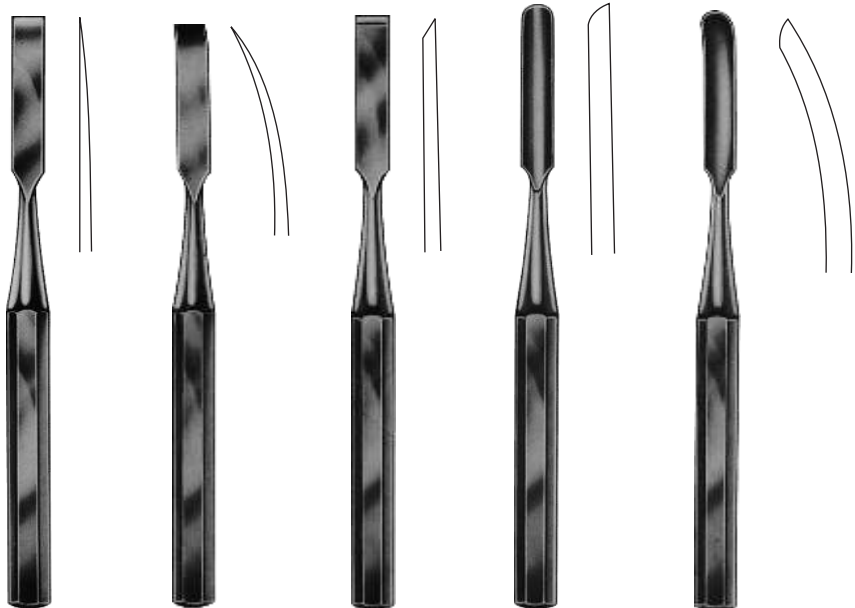

mm	SB-1889-06	SB-1890-06	SB-1891-06	SB-1892-06	SB-1893-06
06	SB-1889-06	SB-1890-06	SB-1891-06	SB-1892-06	SB-1893-06
09	SB-1889-09	SB-1890-09	SB-1891-09	SB-1892-09	SB-1893-09
13	SB-1889-13	SB-1890-13	SB-1891-13	SB-1892-13	SB-1893-13
16	SB-1889-16	SB-1890-16	SB-1891-16	SB-1892-16	SB-1893-16
19	SB-1889-19	SB-1890-19	SB-1891-19	SB-1892-19	SB-1893-19
25	SB-1889-25	SB-1890-25	SB-1891-25	SB-1892-25	SB-1893-25
32	SB-1889-32	SB-1890-32	SB-1891-32	SB-1892-32	SB-1893-32

**Hibbs**  
24 cm/9½"

## Bone Instruments

Bone Gouges  
Knochen Gouges

Gouges os  
Gouges hueso



mm **Lexer**  
05 SB-1894-05  
10 SB-1894-10  
15 SB-1894-15

28 cm/11"



**Lexer**  
SB-1895-05  
SB-1895-10  
SB-1895-15

25 cm/10"



**Lexer**  
SB-1896-05  
SB-1896-10  
SB-1896-15

25 cm/10"



SB-1897-01



SB-1897-02



SB-1898-03



**Cobb**  
28 cm/11"

SB-1899-04

# Bone Instruments

Bone Curettes  
Scharfe Löffel

Curettes osseuses  
Curetas óseas

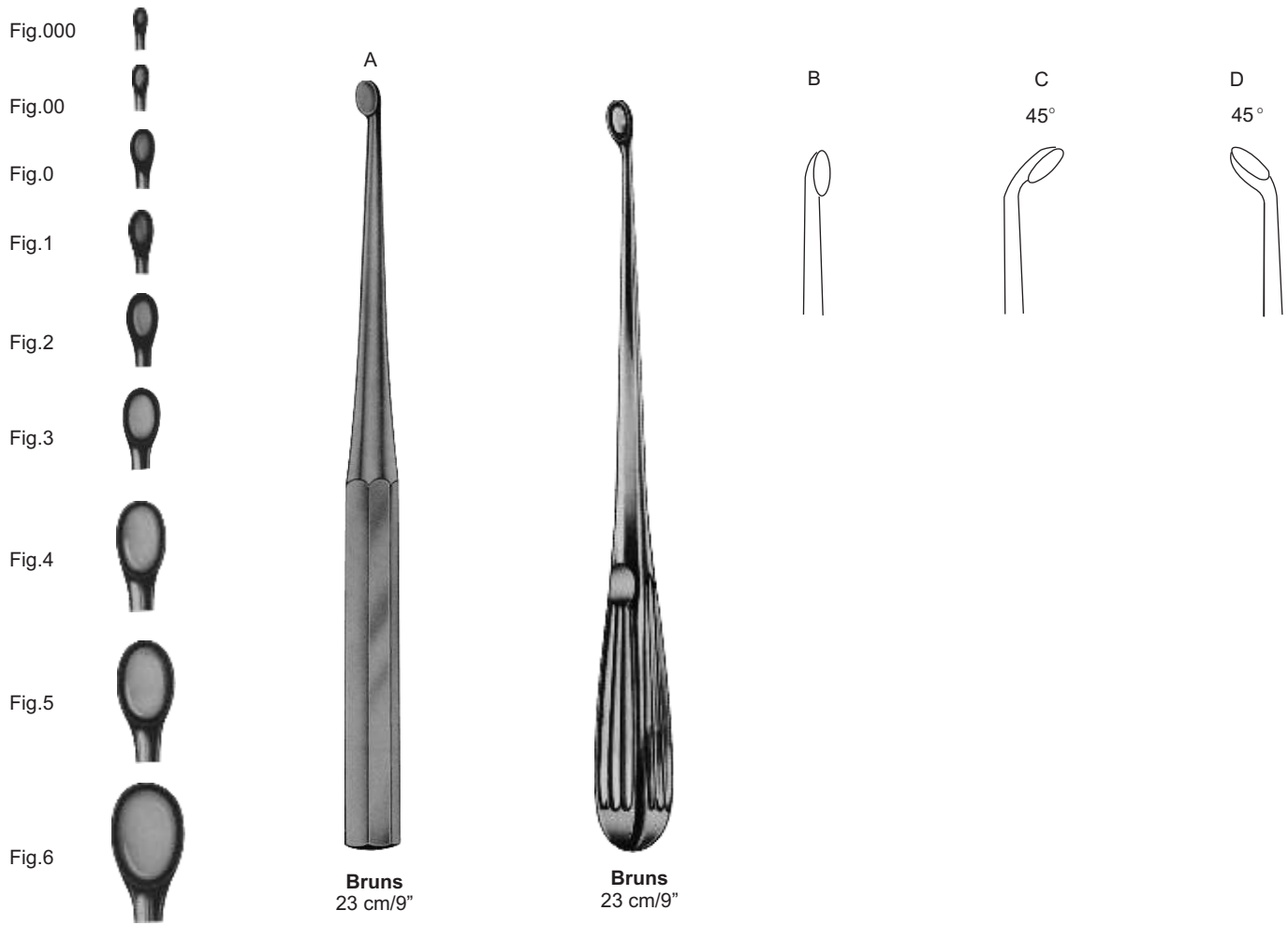

Fig.	A	B	C	D
000	SB-1900-30	SB-1901-30	SB-1902-30	SB-1903-30
00	SB-1900-20	SB-1901-20	SB-1902-20	SB-1903-20
0	SB-1900-10	SB-1901-10	SB-1902-10	SB-1903-10
1	SB-1900-01	SB-1901-01	SB-1902-01	SB-1903-01
2	SB-1900-02	SB-1901-02	SB-1902-02	SB-1903-02
3	SB-1900-03	SB-1901-03	SB-1902-03	SB-1903-03
4	SB-1900-04	SB-1901-04	SB-1902-04	SB-1903-04
5	SB-1900-05	SB-1901-05	SB-1902-05	SB-1903-05
6	SB-1900-06	SB-1901-06	SB-1902-06	SB-1903-06

## Bone Instruments

Bone Curettes  
Scharfe Löffel

Curettes osseuses  
Curetas óseas



**Volkmann**  
17 cm/6¾"

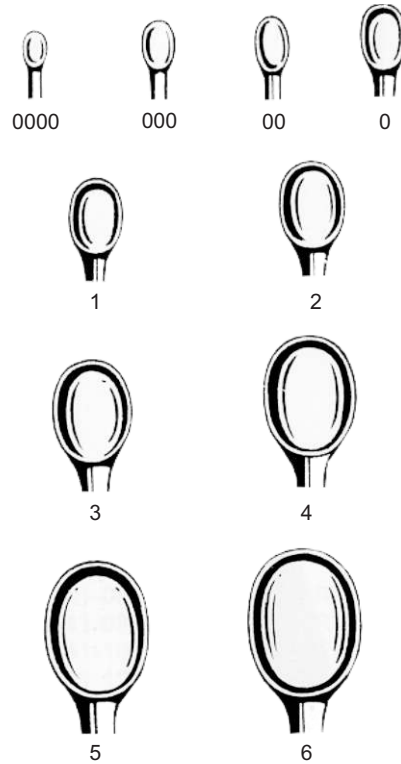

Fig.  
0000 SB-1904-40  
000 SB-1904-30  
00 SB-1904-20  
0 SB-1904-10  
1 SB-1904-01  
2 SB-1904-02  
3 SB-1904-03  
4 SB-1904-04  
5 SB-1904-05  
6 SB-1904-06



**Volkmann**  
17 cm/6¾"

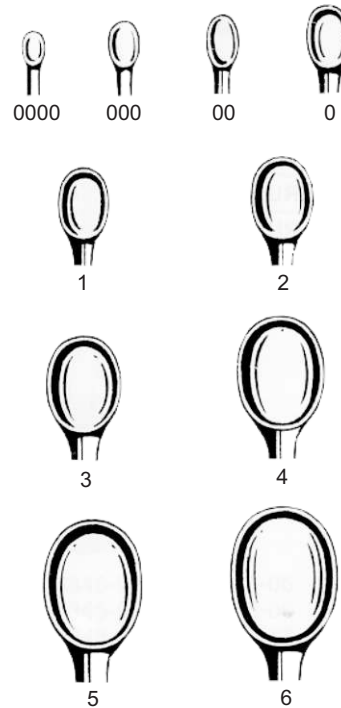

Fig.  
0000 SB-1905-40  
000 SB-1905-30  
00 SB-1905-20  
0 SB-1905-10  
1 SB-1905-01  
2 SB-1905-02  
3 SB-1905-03  
4 SB-1905-04  
5 SB-1905-05  
6 SB-1905-06



# Bone Instruments

Bone Curettes  
Scharfe Löffel

Curettes osseuses  
Curetas óseas



**Bruns**  
17 cm/6¾"

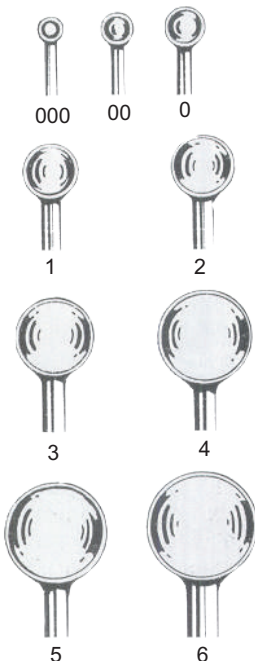

<b>Bruns</b>	<b>Fig.</b>	<b>Spratt</b>
SB-1906-30	000	SB-1907-30
SB-1906-20	00	SB-1907-20
SB-1906-10	0	SB-1907-10
SB-1906-01	1	SB-1907-01
SB-1906-02	2	SB-1907-02
SB-1906-03	3	SB-1907-03
SB-1906-04	4	SB-1907-04
SB-1906-05	5	SB-1907-05
SB-1906-06	6	SB-1907-06



**Spratt**  
16 cm/6¼"

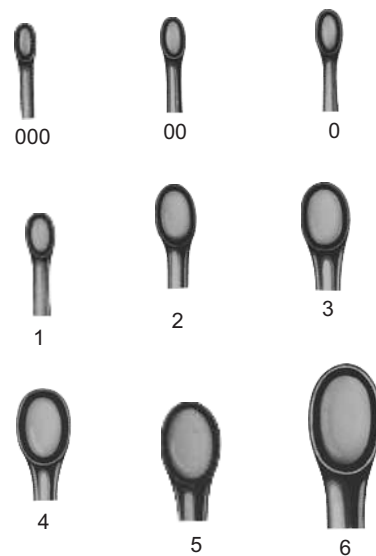

**Swedish pattern**

mm	Round	Oval
2	SB-1908-02	SB-1909-03
3	SB-1908-03	SB-1909-04
4	SB-1908-04	SB-1909-05
5	SB-1908-05	SB-1909-06
6	SB-1908-06	SB-1909-07
7	SB-1908-07	SB-1909-08
8	SB-1908-08	SB-1909-10
10	SB-1908-10	SB-1909-12
12	SB-1908-12	SB-1909-14
14	SB-1908-14	22cm/8 "
	17cm/6¾"	½

## Bone Instruments

Bone Curettes  
Scharfe Löffel

Curettes osseuses  
Curetas óseas

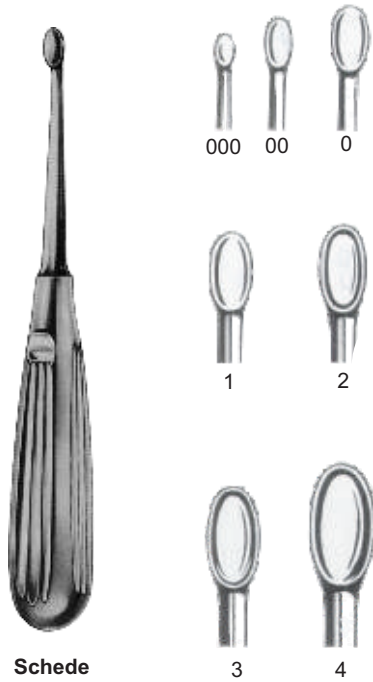

**Schede**  
17 cm/6<sup>3</sup>/<sub>4</sub>"

Fig.	
000	SB-1910-30
00	SB-1910-20
0	SB-1910-10
1	SB-1910-01
2	SB-1910-02
3	SB-1910-03
4	SB-1910-04

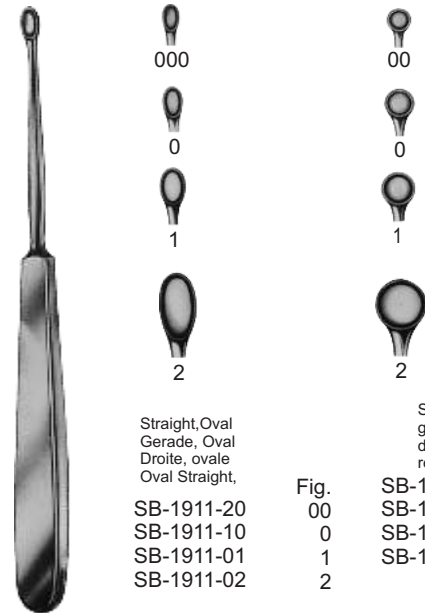

**Williger**  
17.5 cm/7"

Straight, Oval	
Gerade, Oval	
Droite, ovale	
Oval Straight,	
SB-1911-20	
SB-1911-10	
SB-1911-01	
SB-1911-02	

Straight	
gerade	
droit	
recto	
Fig.	SB-1912-20
00	SB-1912-10
0	SB-1912-01
1	SB-1912-02
2	

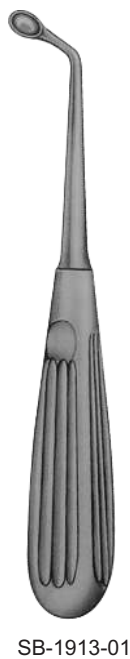

SB-1913-01

**Uffenorde**  
17 cm/6<sup>3</sup>/<sub>4</sub>"



SB-1914-02

## Bone Instruments

Bone Curettes  
Scharfe Löffel

Curettes osseuses  
Curetas óseas

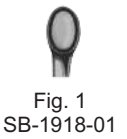

**Volkman**  
27 cm/10½"



**Simon**  
24 cm/9½"



**Simon**  
24 cm/9½"



**Daubenspeck**  
20 cm/8"

## Bone Instruments

Bone Curettes  
Scharfe Löffel

Curettes osseuses  
Curetas óseas

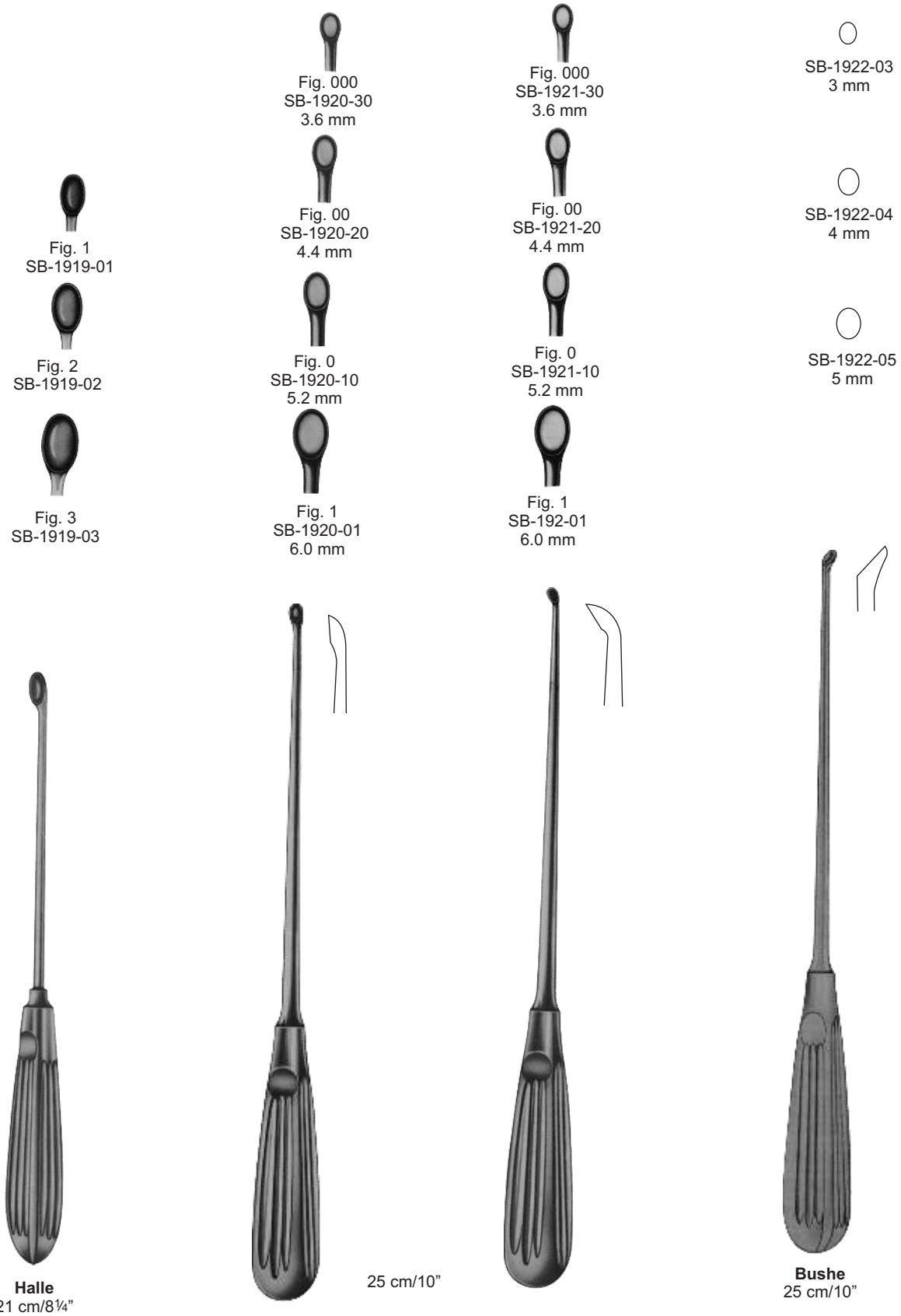

# Bone Instruments

Bone Curettes  
Scharfe Löffel

Curettes osseuses  
Curetas óseas

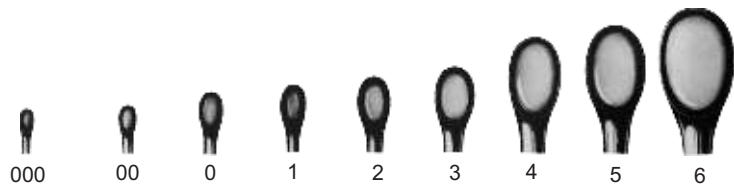

SB-1923-21  
21 cm/8 1/4"

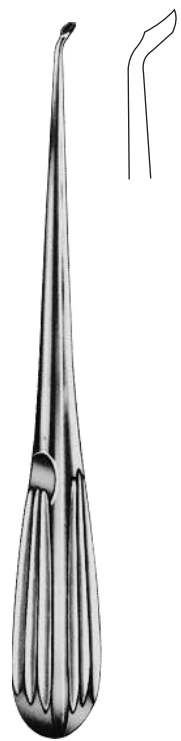

Epstein



Spinal



Spinal

Fig.			
000	SB-1924-30	SB-1925-30	SB-1926-30
00	SB-1924-20	SB-1925-20	SB-1926-20
0	SB-1924-10	SB-1925-10	SB-1926-10
1	SB-1924-01	SB-1925-01	SB-1926-01
2	SB-1924-02	SB-1925-02	SB-1926-02
3	SB-1924-03	SB-1925-03	SB-1926-03
4	SB-1924-04	SB-1925-04	SB-1926-04
5	SB-1924-05	SB-1925-05	SB-1926-05
6	SB-1924-06	SB-1925-06	SB-1926-06
	20 cm/8"	20 cm/8"	20 cm/8"

## Bone Instruments

Bone Curettes  
Scharfe Löffel

Curettes osseuses  
Curetas óseas



Length	Volkmann	
	Oval/Oval	Oval/Round
13 5"	SB-1929-13	SB-1930-13
14 5½"	SB-1929-14	
16 6¼"		SB-1930-16
17 6¾"	SB-1929-17	
20 8"	SB-1929-20	SB-1930-20



## Bone Instruments

Bone Files and Rasps

Knochen-Feilen und Raspeln

Fichiers os et râpes

Archivos de hueso y Escofinas



**Putti**  
SB-1936-30  
30 cm/12"



**Putti**  
SB-1937-27  
27 cm/10½"



SB-1938-25  
25 cm/10"



SB-1939-24  
24 cm/9½"



SB-1940-22  
22 cm/8¾"



## Bone Instruments

Periosteal Raspatories  
periostale Raspatories

périostée Couronne Instruments  
Raspatories periostio



**Farabeuf-Collin**  
SB-1941-15  
15.5 cm/6"  
11 mm



**Farabeuf-Collin**  
SB-1942-15  
15.5 cm/6"  
11 mm



**Farabeuf**  
SB-1943-15  
15 cm/6"



**Farabeuf**  
SB-1944-15  
15 cm/6"

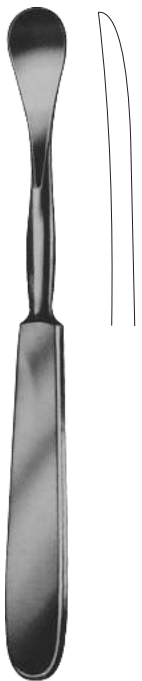

**Sedillot**  
SB-1945-18  
18 cm/7"  
18 mm



**Sedillot**  
SB-1946-21  
21 cm/8<sup>1</sup>/<sub>4</sub>"  
15 mm

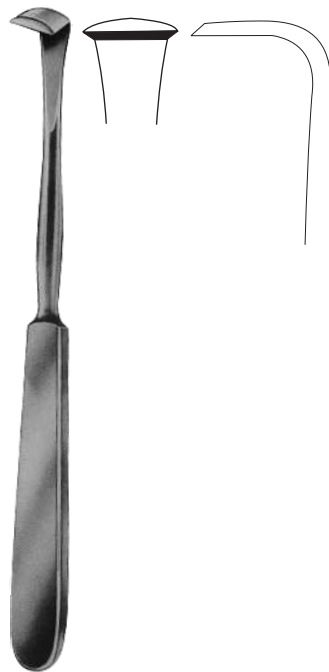

**Langenbeck**  
SB-1947-18  
18 cm/7"



**Langenbeck**  
SB-1948-19  
19 cm/7<sup>1</sup>/<sub>2</sub>"



# Bone Instruments

Periosteal Raspatories  
periostale Raspatories

périostée Couronne Instruments  
Raspatories periostio



**Alexander**  
SB-1949-20  
20 cm/8"



**Lambotte**  
21 cm/8¼"

	mm
SB-1950-05	05
SB-1950-10	10
SB-1950-15	15
SB-1950-20	20
SB-1950-25	25



**Schneider**  
SB-1951-17  
17.5 cm/7"  
13 mm



**Schneider-Sauerbruch**  
SB-1952-19  
19 cm/7½"  
13 mm

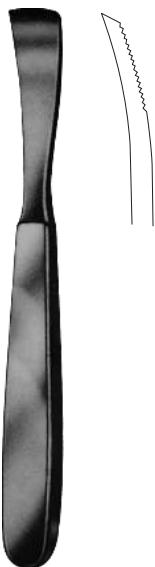

**Jansen**  
SB-1953-16  
16.5 cm/6½"  
15 mm



**Seldin**  
SB-1954-19  
19 cm/7½"



**Davidson-Alexander**  
SB-1955-29  
29 cm/11½"

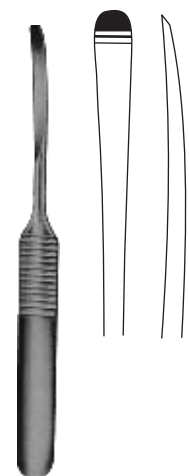

**Williger**  
SB-1956-13  
13 cm/5"

## Bone Instruments

Periosteal Raspatories  
periostale Raspatories

périostée Couronne Instruments  
Raspatories periostio

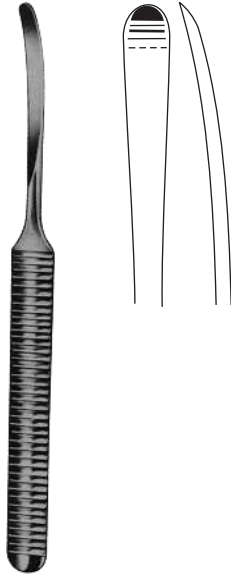

**Williger**  
SB-1957-16  
16 cm/6¼"

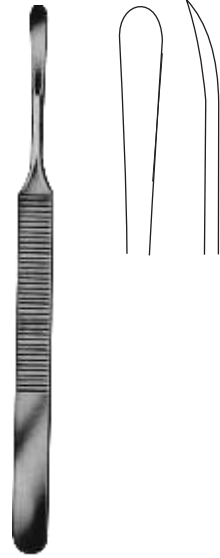

**Konig**  
SB-1958-15  
15.5 cm/6"  
5 mm

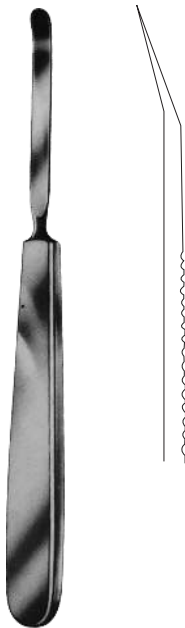

SB-1959-06 17 cm/6¾"  
6 mm SB-1960-08  
8 mm



**Adson**  
17 cm/6¾"

## Bone Instruments

Periosteal Raspatories  
periostale Raspatories

périostée Couronne Instruments  
Raspatories periostio



**Hylin**  
14.5 cm/5¾"



SB-1962-01



SB-1962-02



SB-1962-03



**Matson**  
SB-1963-22  
22 cm/8¾"



**Overholt**  
SB-1964-29  
29.5 cm/11½"



**Overholt**  
SB-1965-29  
29.5 cm/11½"



**Overholt**  
SB-1966-28  
28.5 cm/11¼"

## Bone Instruments

Periosteal Raspatories  
periostale Raspatories

périostée Couronne Instruments  
Raspatories periostio

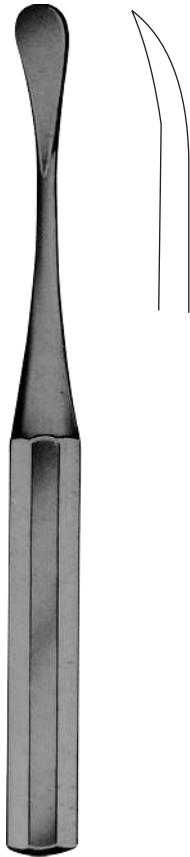

**Cobb**  
24 cm/9½"



SB-1967-04  
4 mm



SB-1967-06  
6 mm



SB-1967-08  
8 mm



SB-1967-10  
10 mm

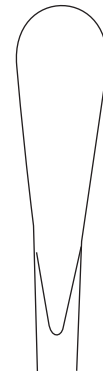

SB-1967-13  
13 mm

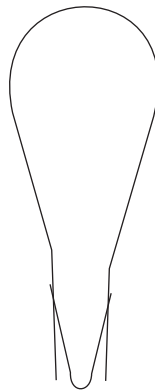

SB-1967-19  
19 mm

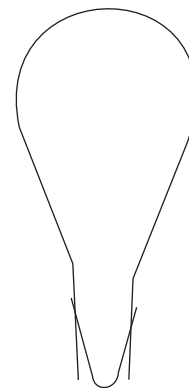

SB-1967-25  
25 mm

# Bone Instruments

Periosteal Raspatories  
periostale Raspatories

périostée Couronne Instruments  
Raspatories periostio



**Doyen**  
17 cm/6¾"

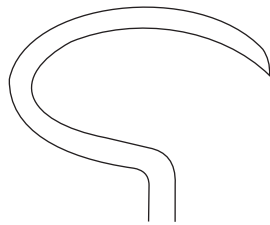

SB-1968-01

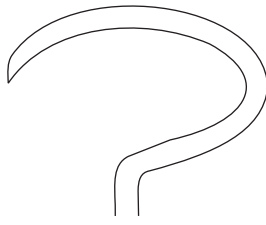

SB-1968-02

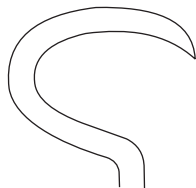

SB-1969-01

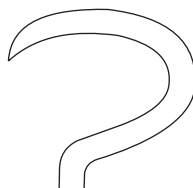

SB-1969-02



SB-1970-01



**Doyen**  
24 cm/9½"



SB-1971-02



**Semb**



SB-1972-01  
19.5 cm/7½"  
12 mm



SB-1972-02  
19.5 cm/7½"  
12 mm



SB-1972-03  
19.5 cm/7½"  
12 mm



SB-1972-04  
22 cm/8¾"  
13 mm



SB-1972-05  
21.5 cm/8½"  
13 mm



SB-1972-06  
22 cm/8½"  
15 mm



SB-1972-07  
22 cm/8½"  
15 mm

## Bone Instruments

Periosteal Raspatories  
periostale Raspatories

périostée Couronne Instruments  
Raspatories periostio



SB-1973-05  
18.5 cm/7¼"  
13 mm



SB-1974-06  
19.5 cm/7¾"  
14 mm



SB-1975-07  
18.5 cm/7¼"  
14 mm

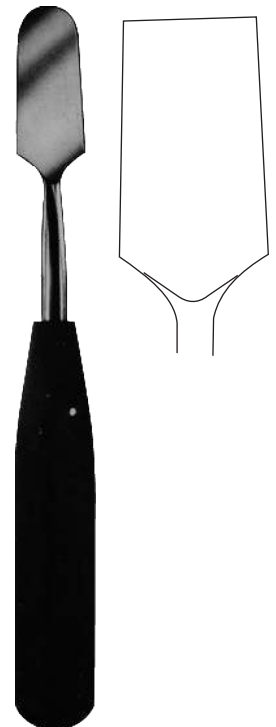

SB-1976-08  
20 cm/8 "  
20 mm



SB-1977-01  
19 cm/7½"  
6 mm



SB-1978-02  
18.5 cm/7¼"  
3 mm



SB-1979-03  
18.5 cm/7¼"  
6 mm



SB-1980-04  
18.5 cm/7¼"  
6 mm

# Bone Instruments

Periosteal Raspatories  
periostale Raspatories

périostée, Couronne Instruments  
Raspatories periostio



SB-1981-20  
27.5 cm/10¾"  
20 mm



**Wagner**  
8 mm SB-1982-08 33 cm/13"  
17 mm SB-1982-17 33 cm/13"



**Cobb**  
10 mm SB-1983-10 25 cm/10"  
13 mm SB-1983-13 25 cm/10"  
19 mm SB-1983-19 25 cm/10"  
25 mm SB-1983-25 25 cm/10"



**Cobb**  
10 mm SB-1984-10 28 cm/11"  
13 mm SB-1984-13 28 cm/11"  
19 mm SB-1984-19 28 cm/11"

## Bone Instruments

Elevators  
Aufzüge

Ascenseurs  
Ascensores



**Langenbeck**  
SB-1985-20  
20 cm/8"  
8 mm

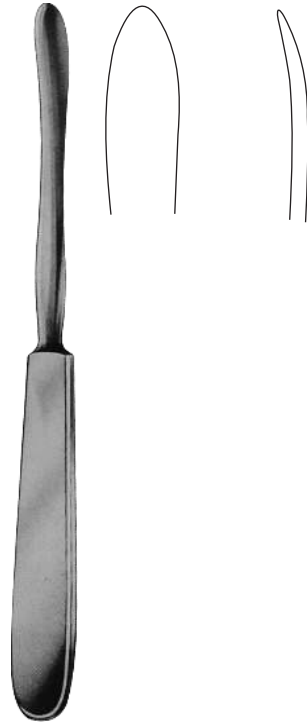

**Langenbeck**  
SB-1986-20  
20 cm/8"  
10 mm

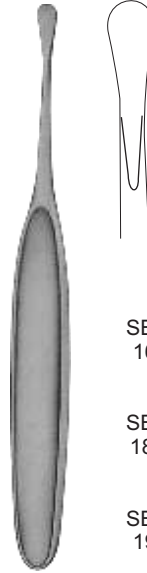

SB-1987-07  
16 cm/6¼"  
7 mm

SB-1987-15  
18.5 cm/7¼"  
15 mm

SB-1987-20  
19 cm/7½"  
20 mm



**Yankauer**  
SB-1988-18  
18 cm/7"

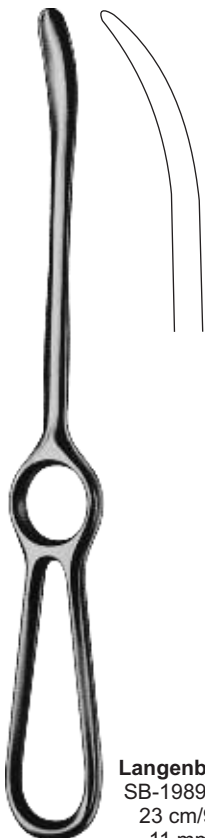

**Langenbeck**  
SB-1989-23  
23 cm/9"  
11 mm

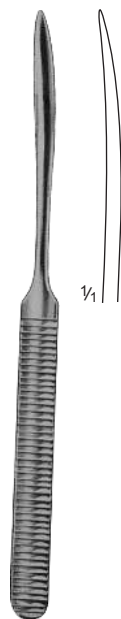

**Williger**  
SB-1990-16  
16 cm/6¼"

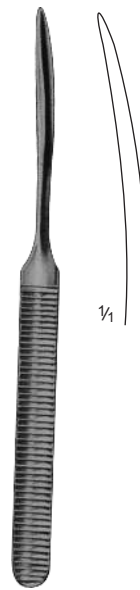

**Williger**  
SB-1991-17  
17 cm/6¾"

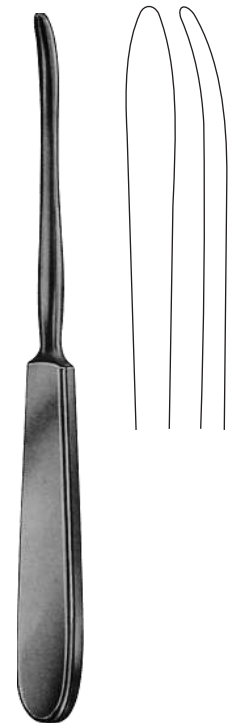

**Quervain**  
SB-1992-20  
20 cm/8"



# Bone Instruments

Elevators  
Aufzüge

Ascenseurs  
Ascensores

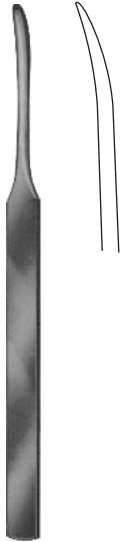

**Konig**  
SB-1993-15  
15 cm/6"  
4.5 mm

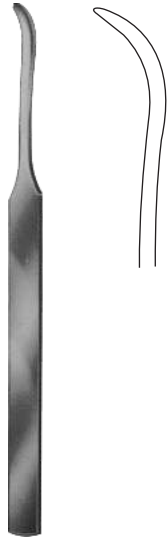

**Konig**  
SB-1994-15  
15 cm/6"  
4.5 mm

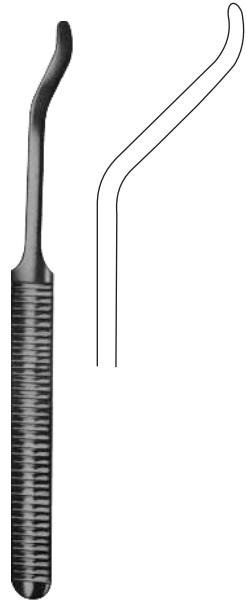

**Hohman-Willinger**  
SB-1995-16  
16 cm/6¼"



6 mm

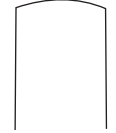

12 mm

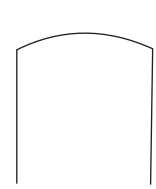

19 mm

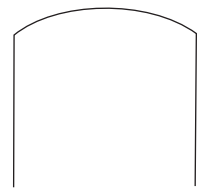

25 mm

**Key**

6 mm	SB-1996-06	19 cm/7½"
12 mm	SB-1996-12	19 cm/7½"
19 mm	SB-1996-19	19 cm/7½"
25 mm	SB-1996-25	19 cm/7½"

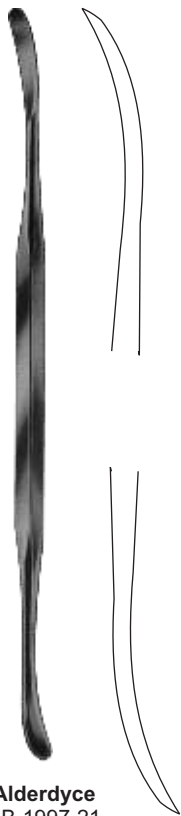

**Alderdyce**  
SB-1997-21  
21 cm/8¼"



**McDonald**  
SB-1998-19  
19 cm/7½"



**Watson-Cheyne**  
SB-1999-19  
17.5 cm/7"

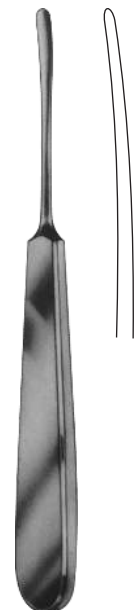

**Sebileau**  
SB-2000-17  
17 cm/6¾"

## Bone Instruments

Bone Levers  
Knochen-Hebel

Leviers os  
Las palancas de hueso

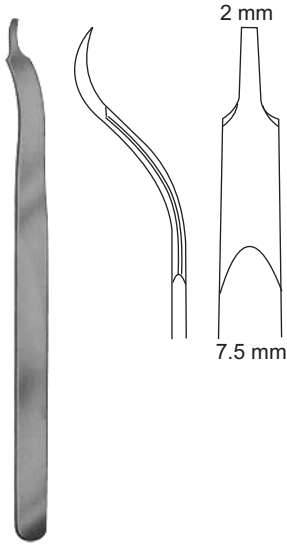

**Buck-Gramcko**  
SB-2001-15  
15 cm/6"

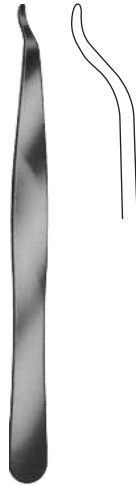

**Hohmann mini**  
SB-2002-14  
14 cm/5½"  
2.8 mm



SB-2003-15  
15 cm/6"  
5 mm

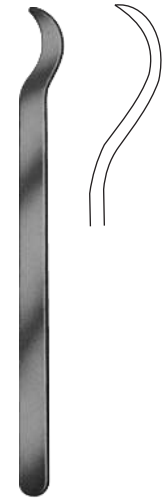

SB-2004-15  
15 cm/6"  
7 mm

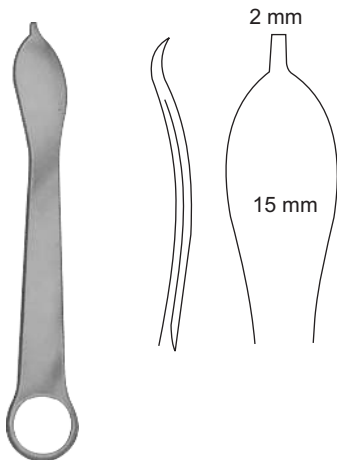

SB-2005-12  
12.5 cm/5"

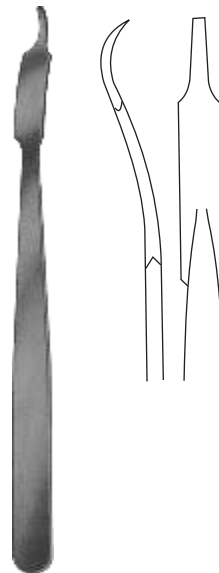

**Mini-Hohmann** SB-2006-06  
16 cm/6¼" 6 mm

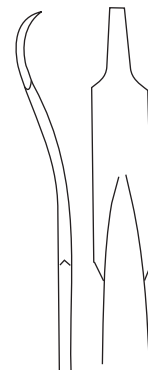

SB-2006-08  
8 mm

## Bone Instruments

Bone Levers  
Knochen-Hebel

Leviers os  
Las palancas de hueso

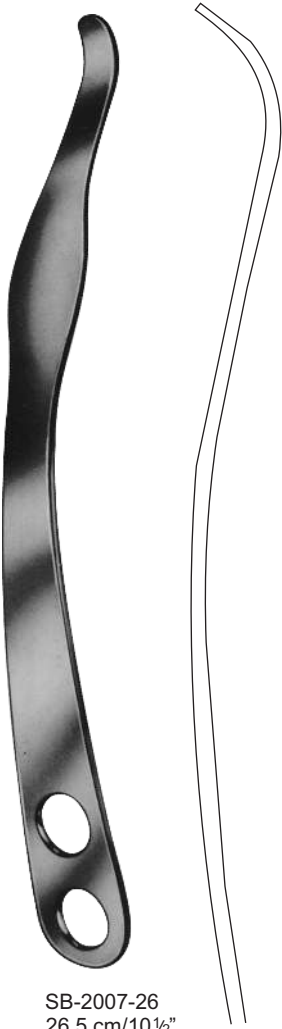

SB-2007-26  
26.5 cm/10½"  
24 mm

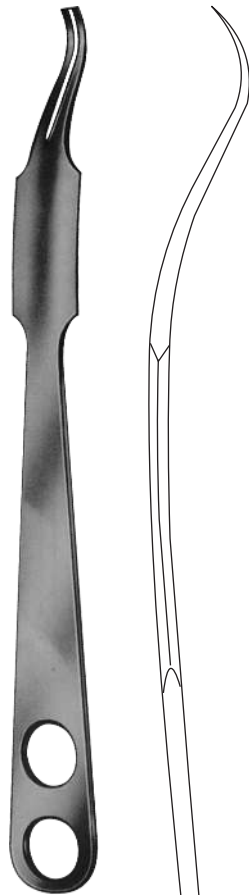

**Lange-Hohmann**  
SB-2008-26  
26 cm/10¼"  
22 mm

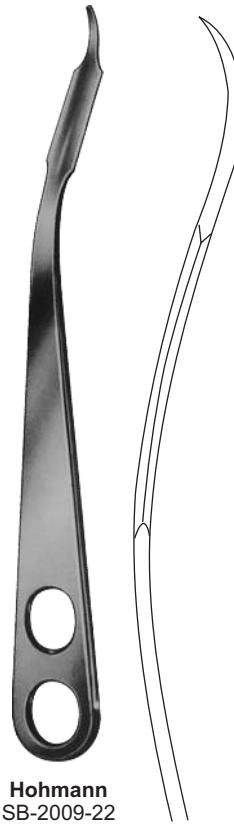

**Hohmann**  
SB-2009-22  
22 cm/8¾"  
8 mm

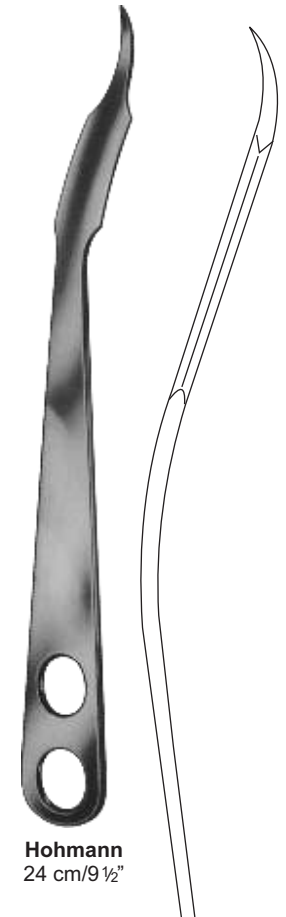

**Hohmann**  
24 cm/9½"

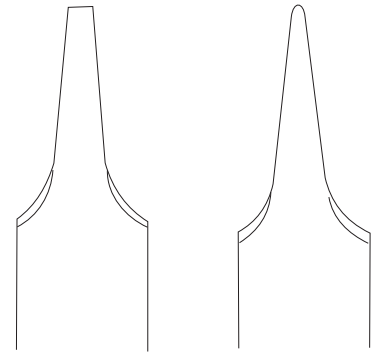

SB-2010-17 17 mm  
SB-2010-18 18 mm

SB-2011-17 17 mm

## Bone Instruments

Bone Levers  
Knochen-Hebel

Leviers os  
Las palancas de hueso



**Hohmann**  
SB-2012-26  
26 cm/10 $\frac{1}{4}$ "  
22 mm

**Hohmann**  
SB-2013-28  
28 cm/11"  
33 mm

**Hohmann**  
SB-2014-24  
24 cm/9 $\frac{1}{2}$ "  
43 mm

**Hohmann**  
SB-2015-24  
24.5 cm/9 $\frac{3}{4}$ "  
43 mm

**Hohmann**  
SB-2016-24  
24 cm/9 $\frac{1}{2}$ "  
70 mm

**Hohmann**  
SB-2017-22  
22 cm/8 $\frac{3}{4}$ "  
18 mm

## Bone Instruments

Bone Levers  
Knochen-Hebel

Leviers os  
Las palancas de hueso



**Lange-Hohmann modif**  
30 mm SB-2018-26 26.5 cm/10 1/2"  
33 mm SB-2018-29 29.0 cm/11 1/2"



**Hohmann-Aldinger**  
SB-2019-27  
27 cm/10 1/2"

24 mm

18 mm



**Schumacher**  
(Wagner)  
SB-2020-34  
34.5 cm/13 1/2"

37 mm

18 mm



**Schumacher**  
SB-2021-29  
29 cm/11 1/2"

35 mm

## Bone Instruments

Bone Levers  
Knochen-Hebel

Leviers os  
Las palancas de hueso

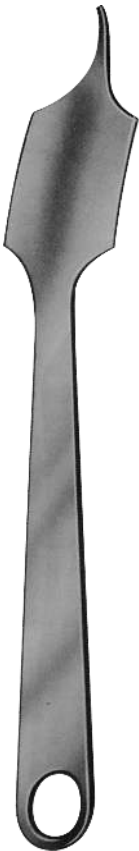
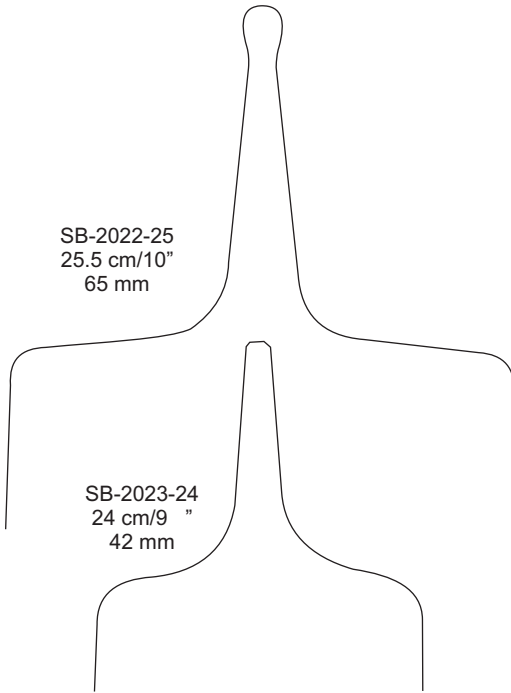

**Verbrugge-Muller**



**Lane Trethowan**  
SB-2027-21  
21.5 cm/8½"



**Lane**  
SB-2025-25  
25.5 cm/10"



**Bristow**  
SB-2026-23  
23 cm/9"

## Bone Instruments

Bone Levers  
Knochen-Hebel

Leviers os  
Las palancas de hueso



**Blount**  
SB-2028-26  
26 cm/10¼"



**Blount**  
SB-2029-26  
26 cm/10¼"



**Bennett** SB-2030-43 43 mm  
24 cm/9½" SB-2030-60 60 mm



**Murphy-Lane**  
SB-2031-32  
32 cm/12½"



**Chandler**

Length Länge longueur longitud	Width Breite largeur ancho	
18 cm	13 mm	SB-2032-13
20 cm	19 mm	SB-2032-19
23 cm	25 mm	SB-2032-23
25 cm	30 mm	SB-2032-30

## Bone Instruments

Meniscus and Spinal Retractors  
Meniskus-und Spinal Retraktoren

Rétracteurs méniscales et de la moelle  
Los retractoros de menisco y la columna vertebral



**Smillie**  
14 cm/5½"

SB-2033-01  
32x19 mm

SB-2033-02  
48x19 mm

SB-2033-03  
57x19 mm



SB-2033-04  
52x13 mm



SB-2033-05  
12x13 mm

Spinal retractors  
Spinal Retraktoren  
écarteurs rachidiens  
retractoros de la columna vertebral



SB-2034-01  
75x30 mm

SB-2034-02  
100x30 mm

**Taylor**  
17 cm/6½"

Meniscus retractors  
Meniskus Retraktoren  
rétracteurs de ménisque  
retractoros de menisco



SB-2035-21  
21.5 cm/8½"



**Blount**  
SB-2036-17  
17.5 cm/7"



## Bone Instruments

Meniscotomy Knives  
Meniscotomy Messer

Couteaux Meniscotomy  
Cuchillos Meniscotomy



**Smillie**  
SB-2037-17  
17 cm/6¾"



**Smillie**  
SB-2038-17  
17 cm/6¾"



**Smillie**  
SB-2039-17  
17 cm/6¾"



**Salenius**  
SB-2040-22  
22 cm/8¾"



**Salenius**  
SB-2041-22  
22 cm/8¾"

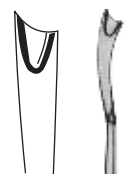
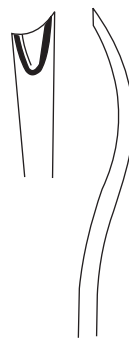
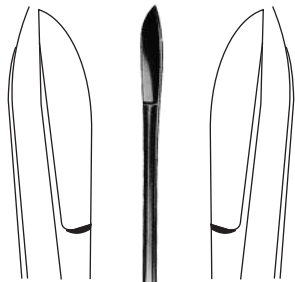

SB-2042-17  
17.5 cm/7"



**Neff**  
SB-2043-01  
21.5 cm/8½"



**Canad-Modell**  
SB-2044-02  
20 cm/8"



SB-2045-20  
20.5 cm/8"



**Bircher**  
SB-2045-20  
20.5 cm/8"

## Bone Instruments

Bone Holding Forceps  
Knochenhaltezaugen

Os Davier  
Bone Pinzas



**Dingmann Modif**  
SB-2046-19  
19 cm/7½"

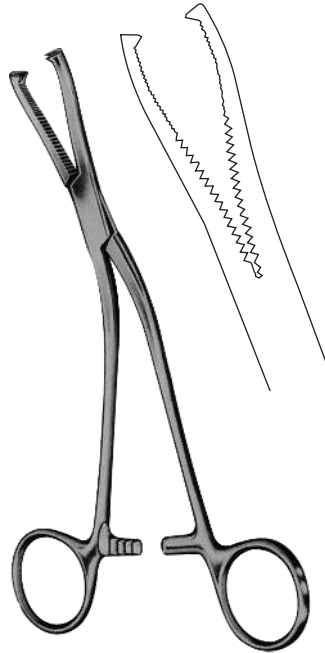

**Dingmann**  
SB-2047-19  
19cm/7½"



**Neff**  
SB-2048-21  
21cm/8¼"



**SB-2049-20**  
20 cm/8"  
Straight  
gerade  
droit  
recto

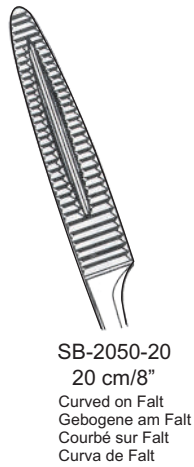

**SB-2050-20**  
20 cm/8"  
Curved on Falt  
Gebogene am Falt  
Courbé sur Falt  
Curva de Falt



**Van Buren**  
SB-2051-23  
23 cm/9"

## Bone Instruments

Bone Holding Forceps  
Knochenhaltezaugen

Os Davier  
Bone Pinzas

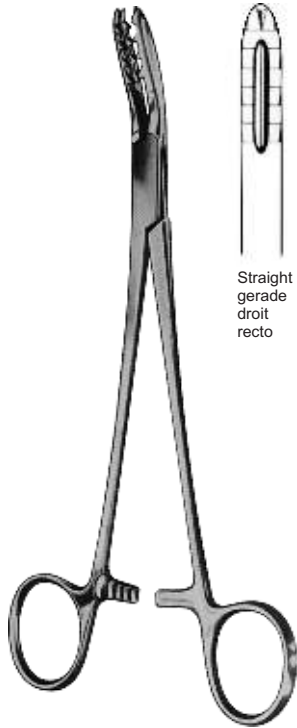

Straight  
gerade  
droit  
recto

**Bircher-Ganske**  
SB-2052-20  
20 cm/8"

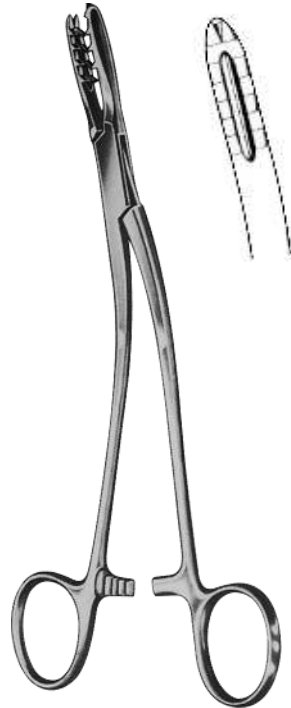

**Bircher-Ganske**  
SB-2053-20  
20 cm/8"



**Martin**  
SB-2054-19  
19 cm/7½"



**Lewin**  
SB-2055-17  
17.5 cm/7"



**Fergusson**  
SB-2056-21  
21 cm/8¼"



**Langenbeck**  
SB-2057-21  
21 cm/8¼"

## Bone Instruments

Bone Holding Forceps  
Knochenhaltezaugen

Os Davier  
Bone Pinzas



Without Ratchet  
ohne Ratchet  
sans cliquet  
Sin Ratchet

SB-2058-17  
SB-2058-21

**Kern**

cm	in
17	6 <sup>3</sup> / <sub>4</sub> "
21	8 <sup>1</sup> / <sub>4</sub> "

With Ratchet  
mit Ratchet  
avec Ratchet  
Con Ratchet

SB-2059-17  
SB-2059-21

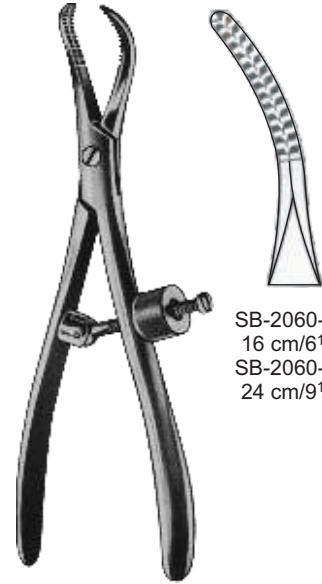

SB-2060-16  
16 cm/6<sup>1</sup>/<sub>4</sub>"  
SB-2060-24  
24 cm/9<sup>1</sup>/<sub>2</sub>"



**Ulrich**  
SB-2061-18  
SB-2061-23  
SB-2061-25  
SB-2061-28



**Ulrich**  
SB-2062-18  
SB-2062-23  
SB-2062-25  
SB-2062-28



**Hey Groves**  
SB-2063-21 20 cm/8"  
SB-2063-27 25 cm/10"  
SB-2063-30 30 cm/12"

## Bone Instruments

Bone Holding Forceps  
Knochenhaltezangen

Os Davier  
Bone Pinzas



**Semb**  
SB-2064-19  
19 cm/7 1/2"



**Semb**  
SB-2065-19  
19 cm/7 1/2"



**Verbrugge**  
SB-2066-17  
17.5 cm/7"



**Verbrugge**

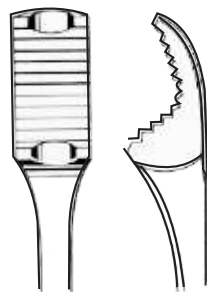

SB-2067-25  
25 cm/10"

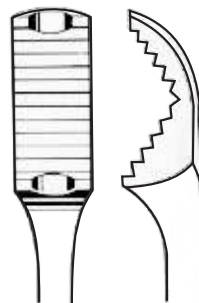

SB-2068-26  
26 cm/10 1/4"  
**Verbrugge**

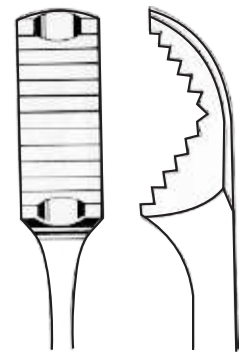

SB-2069-27  
27 cm/10 1/2"

## Bone Instruments

Bone Holding Forceps  
Knochenhaltezaugen

Os Davier  
Bone Pinzas



**Self  
Centring**

SB-2070-15 15 cm/6"  
SB-2070-19 19 cm/7 1/2"  
SB-2070-24 24 cm/9 1/2"  
SB-2070-26 26 cm/10 1/4"  
SB-2070-28 28 cm/11"



Handles Detachable  
Griffe Abnehmbare  
poignées détachables  
Maneja desmontable

**Percy**  
SB-2071-30

Adjustable  
einstellbar  
réglable  
ajustable



**Lambotte**

SB-2072-22 22 cm/8 3/4"  
SB-2072-27 27 cm/10 1/2"  
SB-2072-30 30 cm/12"



**Farabeuf**

SB-2073-23 23 cm/9"  
SB-2073-26 26 cm/10 1/4"



**Lambotte**

SB-2074-22 22.5 cm/9"  
SB-2074-25 25.5 cm/10 1/2"  
SB-2074-33 33 cm/13 1/2"

## Bone Instruments

Bone Holding Forceps  
Knochenhaltezangen

Os Davier  
Bone Pinzas



**Farabeuf-Lambotte**  
SB-2075-26  
26 cm/10¼"



**Lambotte**  
SB-2076-19 19 cm/7½"  
SB-2076-23 23 cm/9"  
SB-2076-26 26 cm/10¼"

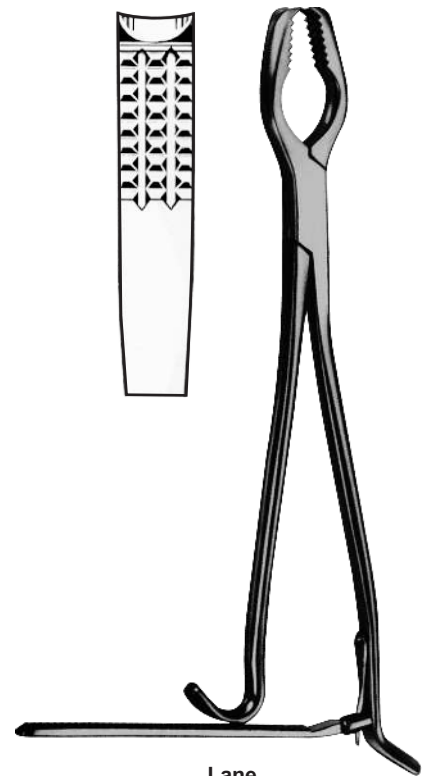

	<b>Lane</b>	
	cm in	
SB-2077-33	33 13"	SB-2078-33
SB-2077-45	45 17¾"	SB-2078-45
Without Ratchet ohne Ratchet sans cliquet Sin Ratchet		With Ratchet mit Ratchet avec Ratchet Con Ratchet



SB-2079-14  
14.5 cm/5¾"



SB-2080-12  
12 cm/4¾"



SB-2081-13  
13.5 cm/5¼"



## Bone Instruments

Bone Holding Forceps and Bone Holding Clamps  
Knochenhaltezange and Bone Halteklammern

Os Davier et os Pinces de portefeuille  
Hueso y huesos Pinzas abrazaderas que sujetan



SB-2082-20  
20 cm/8"



SB-2083-17  
17 cm/6¾"



SB-2084-17  
17.5 cm/7"

Traction Bar  
Traktion Bar  
barre de traction  
tracción Bar



**Lowman-Hoglund**  
SB-2085-19  
19 cm/7½"



**Lowman**  
SB-2086-18 18 cm/7"  
SB-2086-20 20 cm/8"  
SB-2086-22 22 cm/8¾"



**Lowman**  
SB-2087-12  
12 cm/4¾"

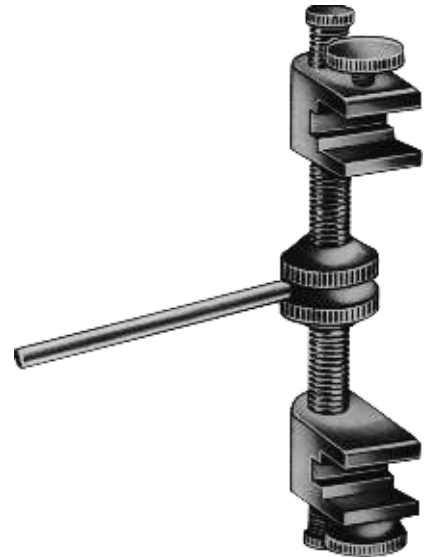

**Gerster**  
SB-2088-18  
SB-2088-50



## Bone Instruments

Bone Rongeur Forceps  
Knochen Hohlmeißelzange

Os Rongeur Forceps  
Pinzas gubia ósea



**Clovis Vincent**  
SB-2089-21 21 cm/8 1/4"  
SB-2089-26 26 cm/10 1/4"

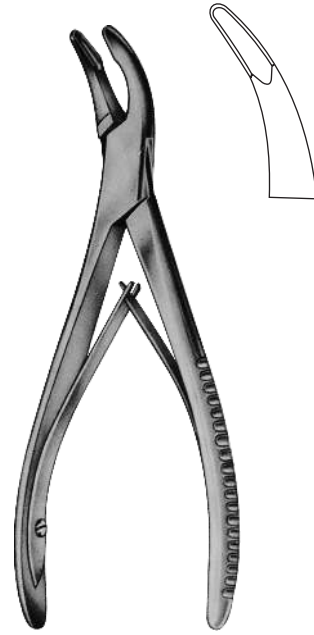

**Bane-Hartmann**  
SB-2090-17  
17.5 cm/7"



**Mini-Friedmann**  
SB-2091-12  
12.5 cm/5"



**Friedmann**  
SB-2092-14  
14 cm/5 1/2"

## Bone Instruments

Bone Rongeur Forceps  
Knochen Hohlmeißelzange

Os Rongeur Forceps  
Pinzas gubia ósea



**Friedmann-Delicate**  
15 cm/6"



SB-2093-15

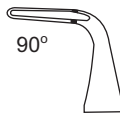

90°

SB-2093-90

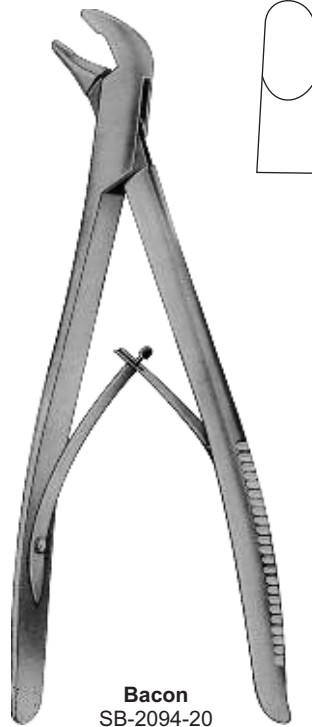

**Bacon**  
SB-2094-20  
20 cm/8"



**Hartmann**  
SB-2095-18  
18.5 cm/7¼"



**Cleveland**  
SB-2096-14 14 cm/5½"  
12-1996-17 17 cm/6¾"



**Olivecrona**  
SB-2097-20  
20 cm/8"

# Bone Instruments

Bone Rongeur Forceps  
Knochen Hohlmeißelzange

Os Rongeur Forceps  
Pinzas gubia ósea



**Lempert**

	cm	in	
SB-2098-16	16	6¼"	SB-2099-16
SB-2098-19	19	7½"	SB-2099-19
Straight gerade droit recto			Curved Gebogene courbé Curvo



**Beyer**  
SB-2300-18  
18 cm/7"



**Mead**  
16.5 cm/6½"



SB-2301-16



SB-2302-16



**Blumenthal**  
15.5 cm/6"



SB-2303-15



SB-2304-15



SB-2305-15



**Hakansson**  
SB-2306-15  
15.5 cm/6"



**Jansen**  
18 cm/7"



SB-2307-17



SB-2308-17

## Bone Instruments

Bone Rongeur Forceps  
Knochen Hohlmeißelzange

Os Rongeur Forceps  
Pinzas gubia ósea



**Stille-Luer**  
22 cm/8¾"



SB-2309-22

Straight  
gerade  
droit  
recto



SB-2310-22

Curved  
Gebogene  
courbé  
Curvo



**Stille-Luer**  
27 cm/10½"



SB-2311-27



SB-2312-27



**Semb**  
SB-2313-23  
23 cm/9"

## Bone Instruments

Bone Rongeur Forceps  
Knochen Hohlmeißelzange

Os Rongeur Forceps  
Pinzas gubia ósea



**Jansen**  
SB-2314-18  
18 cm/7"

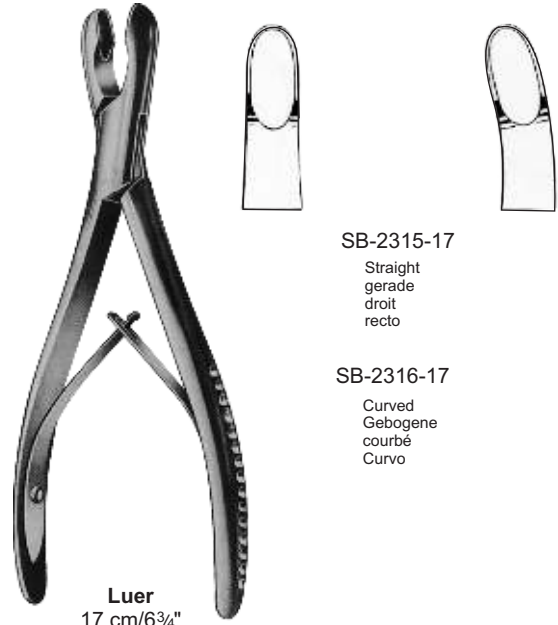

SB-2315-17  
Straight  
gerade  
droit  
recto

SB-2316-17  
Curved  
Gebogene  
courbé  
Curvo



Heavy Pattern  
schwere Pattern  
modèle lourd  
patrón pesado

**Luer**  
18.5 cm/7¼"  
SB-2317-15



SB-2318-15

SB-2319-15

**Luer**  
15 cm/6"

SB-2320-15



SB-2321-20

**Adson**  
20 cm/8"

## Bone Instruments

Bone Rongeur Forceps  
Knochen Hohlmeißelzange

Os Rongeur Forceps  
Pinzas gubia ósea



**Bohler**  
15cm/6"

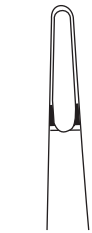

SB-2322-15



SB-2323-15



**Kleinert-Kutz**  
15cm/6"

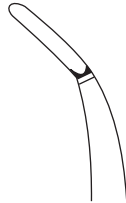

SB-2324-15  
2mm



SB-2325-15  
3mm



**Beyer  
Zaufal-Jansen**  
18 cm/7"



**Zaufal-Jansen**  
SB-2326-18

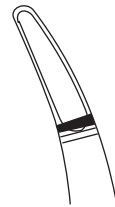

**Beyer**  
SB-2327-18



**Mayfield**  
SB-2328-17  
17 cm/6 3/4"



**Ruskin**  
SB-2329-18  
18 cm/7"

Straight  
gerade  
droit  
recto  
SB-2330-18  
18 cm/7"  
SB-2330-23  
23 cm/9"



**Ruskin**



Straight  
gerade  
droit  
recto  
SB-2331-18  
18 cm/7"  
SB-2331-23  
23 cm/9"

## Bone Instruments

Bone Rongeur Forceps  
Knochen Hohlmeißelzange

Os Rongeur Forceps  
Pinzas gubia ósea



**Marquardt**  
SB-2332-20  
20 cm/8"



**Rottgen-Ruskin**  
SB-2333-24  
24 cm/9½"



**Smith-Petersen**  
24 cm/9½"



SB-2334-03  
3 mm



SB-2334-04  
4 mm



SB-2334-05  
5 mm



SB-2335-03  
3 mm



SB-2335-04  
4 mm



SB-2335-05  
5 mm



## Bone Instruments

Bone Rongeur Forceps  
Knochen Hohlmeißelzange

Os Rongeur Forceps  
Pinzas gubia ósea



**Stille-Ruskin**  
SB-2336-23  
23 cm/9"



**Echlin**  
23 cm/9"

SB-2337-02  
2 mm

SB-2337-03  
3 mm

SB-2337-04  
4 mm



**Leksell**  
23 cm/9"

SB-2338-03  
3 mm

SB-2338-04  
4 mm

SB-2338-06  
6 mm

SB-2338-08  
8 mm



**Frykholm**  
SB-2339-23  
23 cm/9"



**Stille**  
SB-2340-23  
23 cm/9"



**Sauerbruch**  
30 cm/12"

SB-2341-30

SB-2342-30



## Bone Instruments

Bone Cutting Forceps  
Knochensplitterzangen

Pince de coupe d'os  
Pince de coupe d'os...

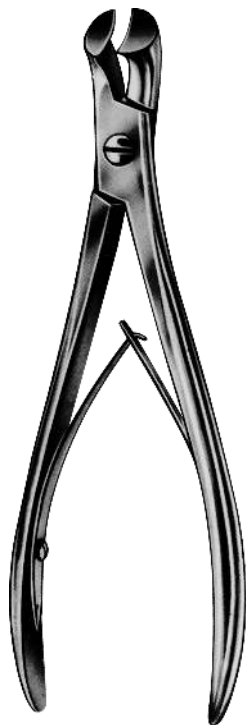

**Markwalder**  
SB-2343-20  
20 cm/8"



cm **Liston** in  
SB-2344-14 14 5 1/2  
SB-2344-17 17 6 3/4  
SB-2344-19 19 7 1/2  
SB-2344-22 22 8 3/4

Straight  
gerade  
droit  
recto



Curved  
Gebogene  
courbé  
Curvo



**Littauer-Liston**  
SB-2346-15  
15 cm/6"



**Cleveland**  
SB-2347-15 15 cm/6"  
SB-2347-17 17 cm/6 3/4"



**Bohler**  
15 cm/6"

SB-2348-15  
Straight  
gerade  
droit  
recto



SB-2349-15  
Curved on flat  
Gebogene auf flachen  
Courbé sur le plat  
Curva plana en



**McIndoe**  
SB-2350-17  
17.5 cm/7"

## Bone Instruments

Bone Cutting Forceps  
Knochensplitterzangen

Pince de coupe d'os  
Pince de coupe d'os...



**Liston-Key(Horsley)**  
SB-2351-27  
27 cm/10½"

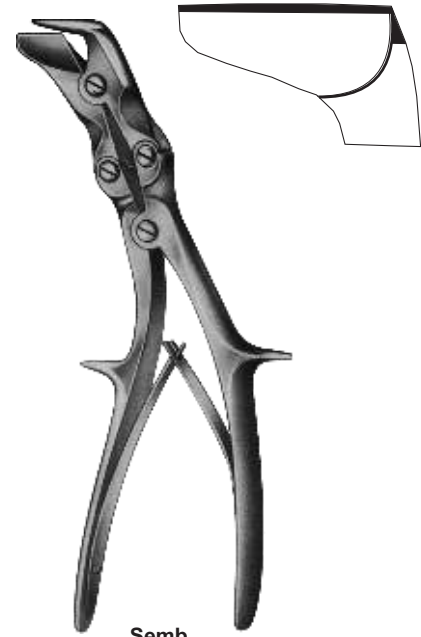

**Semb**  
SB-2352-27-24  
24 cm/9½"



**Kazanjian**  
SB-2353-27-18  
18 cm/7"



**Ruskin-Liston**  
18.5 cm/7¼"

SB-2354-18  
Straight  
gerade  
droit  
recto



SB-2355-18  
Curved on flat  
Gebogene auf flachen  
Courbé sur le plat  
Curva plana en



**Stille-Liston**  
23 cm/9"  
27 cm/10½"

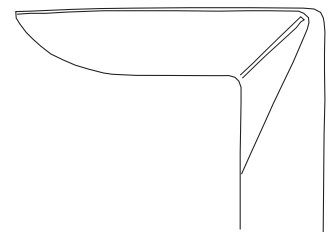

SB-2356-27  
27 cm/10½"

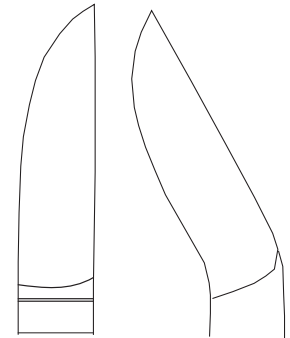

SB-2357-23  
SB-2357-27

SB-2358A-23  
SB-2358A-27

## Bone Instruments

Nail Instruments and Finger Ring Cutters  
Nail Instruments und Fingerring Schneider

Nail Instruments et couteaux pour bagues  
Instrumentos y cortadores de uñas del dedo del anillo



SB-2358-13  
13.5 cm/5"



18 cm/7"

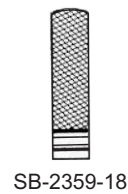

SB-2359-18



SB-2360-18



**Radolf**  
SB-2361-13  
13.5 cm/5¼"



SB-2362-17  
17 cm/6¾"

Saw blade  
Sägeblatt  
lame de scie  
hoja de sierra



**Walton**  
SB-2363-17  
17 cm/6¾"

Saw blade  
Sägeblatt  
lame de scie  
hoja de sierra

## Bone Instruments

Amputation and Resection Saws  
Amputation und Resektion Sägen

Scies d'amputation et résection  
Amputación y resección Sierras



**Langenbeck**  
SB-2364-23  
23 cm/9"



**Satterlee**  
SB-2365-31  
31 cm/12¼"



**Charriere**  
SB-2366-27 27 cm/10½"  
SB-2366-30 30 cm/12"  
SB-2366-34 34 cm/13½"

Spare saw blades  
Spare Sägeblättern  
Lames de scie de rechange  
Cuchillas de recambio sierra

SB-2367-43 3 mm  
SB-2367-45 5 mm  
SB-2367-47 7 mm

Complete with 3 blades  
Komplett mit 3 Klingen  
Livré avec 3 lames  
Completo con 3 cuchillas  
12-2067-39



**Helferich-Bier**

Spare saw blades  
Spare Sägeblättern  
Lames de scie de rechange  
Cuchillas de recambio sierra

SB-2368-12 12 mm  
SB-2368-15 15 mm

Complete with 2 blades  
Komplett mit 2 Klingen  
Livré avec 2 lames  
Completo con 2 cuchillas  
12-2068-35



**Charriere**

## Bone Instruments

Bone Drills  
Bone Drills

Perceuses os  
Bone Drills



**Adjustable handle**  
SB-2369-28  
28cm/11"

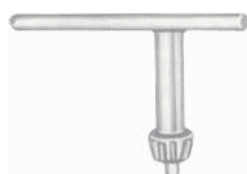

SB-2370-11  
Key only  
Key nur  
seule clé  
clave única



**Ralk**  
SB-2371-00  
accomodating up to 6.35mm Ø

## Bone Instruments

Bone Drills  
Bone Drills

Perceuses os  
Bone Drills

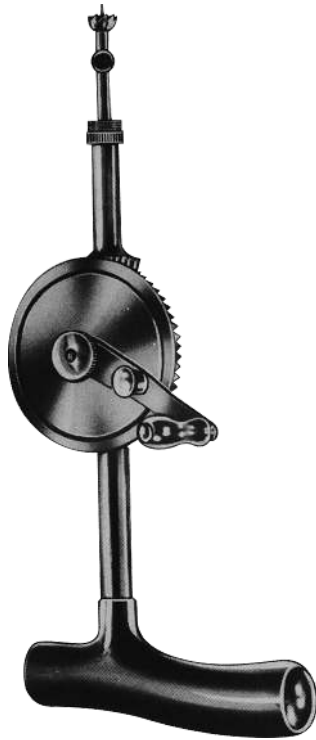

**Stille**  
12-2072-00



Fig. 1  
SB-2372-01  
Ø2,5mm



Fig. 2  
SB-2372-02  
3,0mm



Fig. 3  
SB-2372-03  
3,5mm



Fig. 4  
SB-2372-04  
4,0mm



Fig. 5  
SB-2372-05  
10,0mm



Fig. 6  
SB-2372-06  
5,0mm



Fig. 7  
SB-2372-07  
Ø8,0mm



Fig. 8  
SB-2372-08  
12,0mm



Fig. 9  
SB-2372-09  
16,0mm



**Hudson**  
12-2073-00  
27cm/10½"



Fig. 1  
SB-2373-01  
Ø 9 mm



Fig. 2  
SB-2373-02  
14mm



Fig. 3  
SB-2373-03  
16mm



Fig. 4  
SB-2373-04  
22mm



**Cushing**  
SB-2373-05  
Ø14mm



**Mckenzie**  
SB-2373-09  
Ø13mm



SB-2373-00

## Bone Instruments

Drill Guide and Dura Protecting Forceps  
Bohrerführung und Dura Schutz Zange

Guide-mèche et Pince Dura Protection  
Guía de broca y pinzas Dura Protección



**Adson**  
SB-2374-15  
15 cm/6"

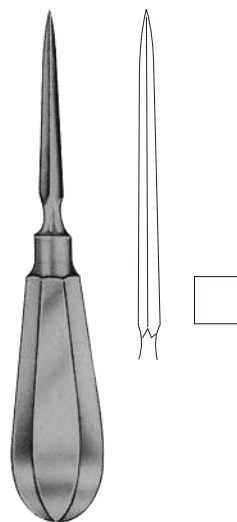

SB-2375-14  
14 cm/5½"



SB-2376-14  
14 cm/5½"

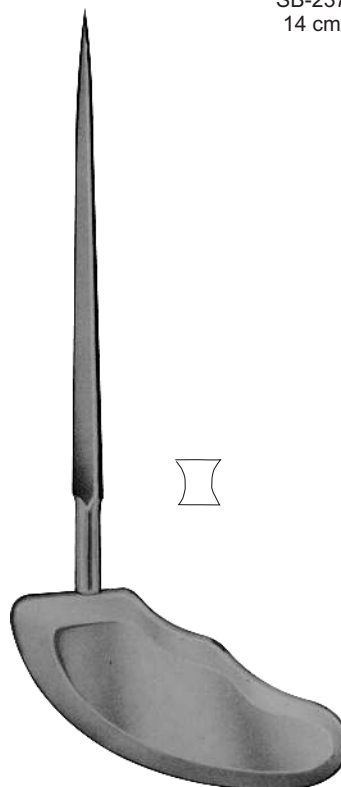

**Perthes**  
SB-2377-21  
21 cm/8¼"



## Bone Instruments

Wire Seizing Forceps  
Draht Zange ergreifen

Pince fil Saisir  
Pinzas de alambre Aprovechar

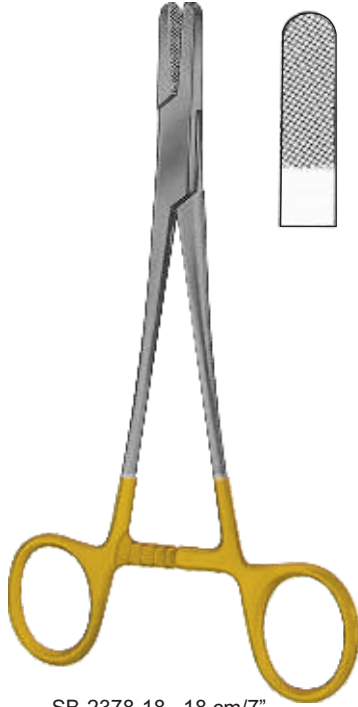

SB-2378-18 18 cm/7"  
SB-2378-20 20 cm/8"

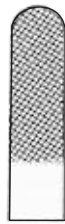

SB-2379-16  
15 cm/6"

SB-2379-20  
20 cm/8"

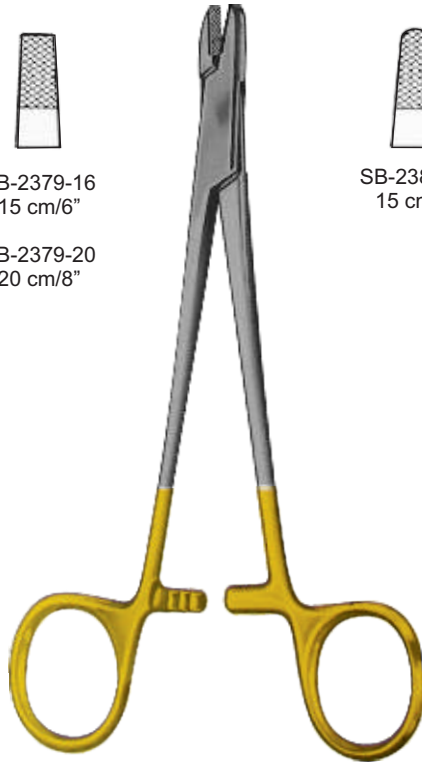

SB-2380-16  
15 cm/6"



SB-2381-14  
14 cm/5½"



SB-2382-16  
16 cm/6¼"

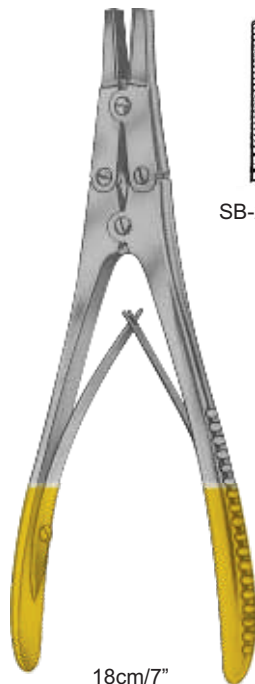

18cm/7"



SB-2383-01



SB-2383-02



SB-2383-03



SB-2383-04



SB-2383-05



## Bone Instruments

Wire Seizing Forceps  
Draht Zange ergreifen

Pince fil Saisir  
Pinzas de alambre Aprovechar



SB-2384-15  
15.5 cm/6"

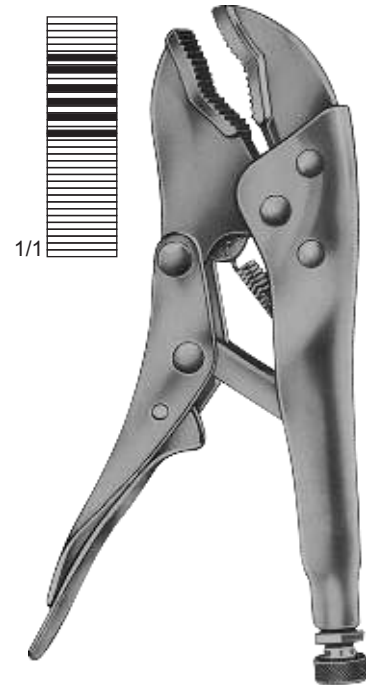

SB-2385-18  
18 cm/7"



SB-2386-13 13 cm/5"  
SB-2386-18 18 cm/7"

## Bone Instruments

Wire Cutting Pliers  
Drahtschneidezangen

Pince coupante fil  
Alicates de corte de alambre

For soft wire  
with a diam. of max.

For hard wire  
with a diam. of max.



SB-2388-15  
24 cm/9 1/2"  
4.0 mm  
3.5 mm



SB-2389-18  
18.5 cm/7 1/4"  
1.7 mm  
1.7 mm



2.0 mm  
1.5 mm  
SB-2390-15  
15 cm/6"



2.0 mm  
2.0 mm  
SB-2391-16  
16 cm/6 1/4"

## Bone Instruments

Wire Cutting Pliers  
Drahtschneidezangen

Pince coupante fil  
Alicates de corte de alambre



SB-2392-12  
12 cm/4 3/4"

0.7 mm  
0.5 mm



SB-2393-15  
15 cm/6"

2.0 mm  
1.0 mm



SB-2394-18  
18 cm/7"

2.0 mm  
1.7 mm

## Bone Instruments

Wire Cutting Pliers  
Drahtschneidezangen

Pince coupante fil  
Alicates de corte de alambre



SB-2395-18  
18.5 cm/7 1/4"



SB-2396-18  
18 cm/7"

SB-2397-22  
22 cm/8 3/4"



SB-2398-22  
22 cm/8 3/4"



SB-2399-47 47 cm/18 1/2"  
SB-2399-57 57 cm/22 1/2"

# Bone Instruments

Extension Bows  
Erweiterung Bögen

Arcs d'extension  
Arcos de extensión

with 3 traction hooks  
mit 3 Traktion Haken  
avec 3 crochets de traction  
con 3 ganchos de tracción

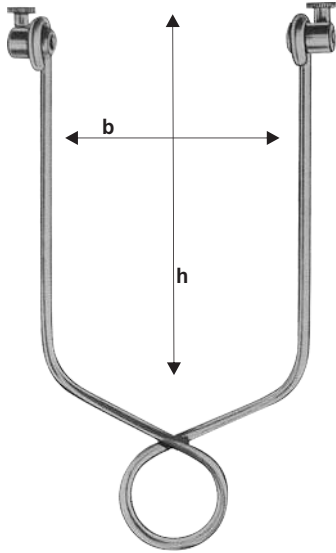

cm h x b	in h x b	
16 x 9	6 1/4 x 3 1/2	SB-2390-16
21 X 11	8 1/4 X 4 1/2	SB-2400-21
21 X 15	8" X 6"	SB-2400-15



**Kirschner**

Clear width  
lichte Breite  
largeur libre  
anchura libre

	cm	In
SB-2401-01	9,5x7	3 3/4 x 2 3/4
SB-2401-02	10,5x10,5	4 1/4 x 4 1/4
SB-2401-03	12x12	4 3/4 x 4 3/4
SB-2401-04	15,5x15,5	6x6
SB-2401-05	20x15,5	8x6

with 3 traction hooks  
mit 3 Traktion Haken  
avec 3 crochets de traction  
con 3 ganchos de tracción



12-2104-40



12-2104-42



**Kirschner**

Clear width  
lichte Breite  
largeur libre  
anchura libre

SB-2402-18  
SB-2402-27

cm	in
18x10	07x04
27x16	10 1/2 x 6 1/4



**Kirschner**

SB-2403-01 Small Pattern  
SB-2403-02 Medium Pattern  
SB-2403-03 Large Pattern

Wire Strainer  
Draht Strainer  
Passoire fil  
Colador de alambre



SB-2404-20

## Bone Instruments

Bone Wire, Twisting Instruments and Guides  
Knochen-Wire, Zwirn-Instrumente und Guides

Fil d'os, instruments de torsion et Guides  
Alambre de hueso, instrumentos giratorios y guías

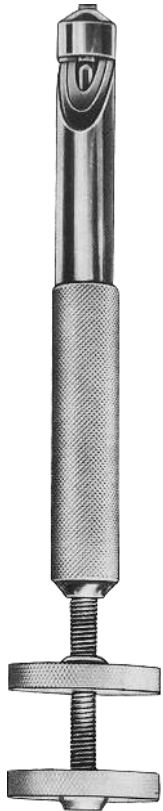

Bone Wire Tighteners  
Knochen Draht Spanner  
Tendeurs Fils os  
Tensores de cables y Bone

**Loute**  
SB-2405-21  
21 cm/8¼"



**Demel**  
SB-2406-28  
28 cm/11"



**Demel**

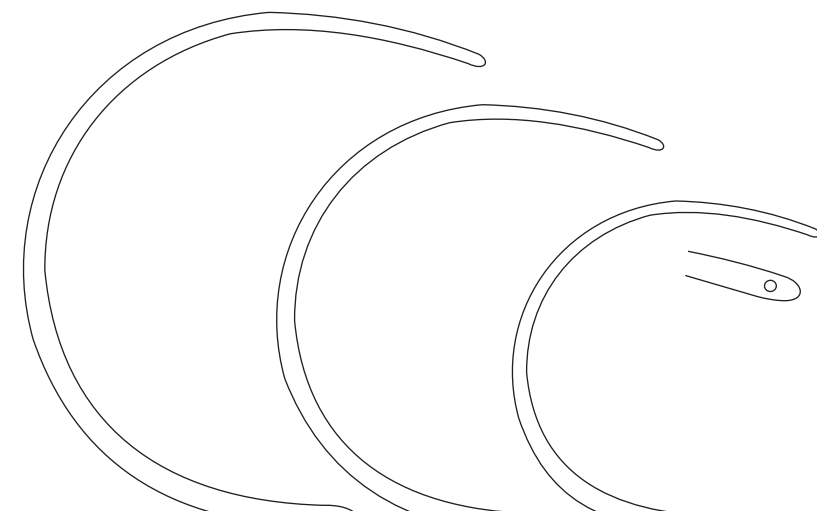

Bone Wire Guides  
Knochen Draht Guides  
Guides-câbles os  
Guías Bone Wire

Fig. 1 SB-2407-01  
Fig. 2 SB-2407-02  
Fig. 3 SB-2407-03

Fig. 1

Fig. 2

Fig. 3

# Bone Instruments

Bone Nail  
Knochennagel

Des clous à os  
Bone uñas



length **Schanz**

length	Ø 5 mm
8 cm	SB-2408-08
10 cm	
12 cm	SB-2408-12
14 cm	
15 cm	SB-2408-15
16 cm	
17 cm	SB-2408-17
18 cm	
20 cm	SB-2408-20
22 cm	
25 cm	SB-2408-25
30 cm	

with triangular end  
mit dreieckigem Ende  
avec extrémité triangulaire  
con extremo triangular



with trocar point  
mit Trokarspitze  
avec pointe trocar  
con punto de trocar

Length  
Länge  
longueur  
longitud

**Steinmann**

Length	Ø 4 mm	Ø 4,5 mm	Ø 5 mm
8 cm	SB-2409-08	SB-2410-08	SB-2411-08
10 cm	SB-2409-10	SB-2410-10	SB-2411-10
12 cm	SB-2409-12	SB-2410-12	SB-2411-12
14 cm	SB-2409-14	SB-2410-14	SB-2411-14
15 cm			
16 cm	SB-2409-16	SB-2410-16	SB-2411-16
17 cm			
18 cm	SB-2409-18	SB-2410-18	SB-2411-18
20 cm	SB-2409-20	SB-2410-20	SB-2411-20
22 cm	SB-2409-22	SB-2410-22	SB-2411-22
25 cm	SB-2409-25	SB-2410-25	SB-2411-25
30 cm	SB-2409-30	SB-2410-30	SB-2411-30

## Bone Instruments

Mallets  
Mallets

Maillets  
mazos



22 cm/8 1/2"

300 g SB-242-10  
500 g SB-242-35  
600 g SB-242-50  
940 g SB-242-70



with interchangeable  
mit austauschbaren  
avec interchangeables  
intercambiable con

Ø 30 mm  
215 g

SB-2413 -24  
24.5 cm/8 3/4"

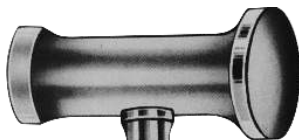

Ø 30 mm  
400 g

Ø 42 mm

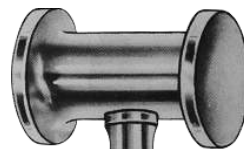

Ø 45 mm  
300 g

Ø 30 mm  
400 g

Ø 42 mm



SB-2414 -24  
24 cm/9 1/2"



**Bergmann**  
SB-2415-24  
24 cm/9 1/2"

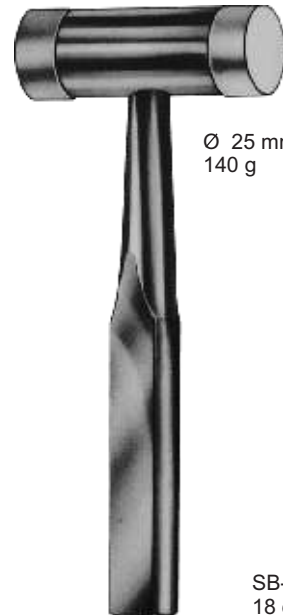

Ø 25 mm  
140 g

SB-2416-18  
18 cm/7"



## Bone Instruments

Mallets  
Mallets

Maillets  
mazos



150 g



**Williger**  
SB-2417-23  
23 cm/9"



∅ 30 mm  
460 g



**Bergmann**  
SB-2418-23  
23 cm/9"

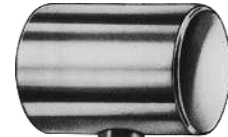

1 Side Flat  
1 Side Convex



**Cottle**  
SB-2419-19  
∅ 30 mm  
19 cm/7 1/2"  
350 g



∅ 42 mm  
400 g

∅ 42 mm  
250 g



SB-2420-24  
24cm/9 1/2"

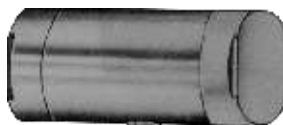

∅ 30 mm



**Ombredanne**  
SB-2421-24  
23.5cm/9 1/4"

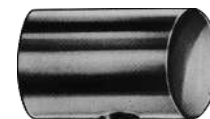

∅ 40 mm



**Heath**  
SB-2422-18  
18 cm/7"

## Bone Instruments

Mallets  
Mallets

Maillets  
mazos

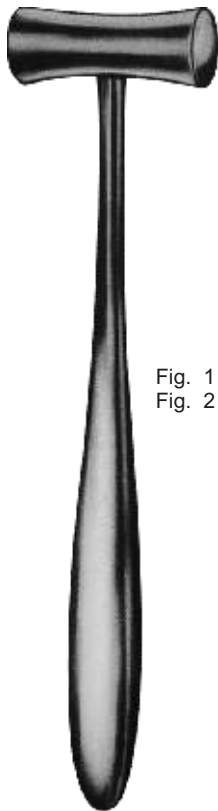

**Lucae**  
19 cm/7½"

Fig. 1 SB-2423-19 19mm Ø 230 g  
Fig. 2 SB-2423-25 25mm Ø 260 g

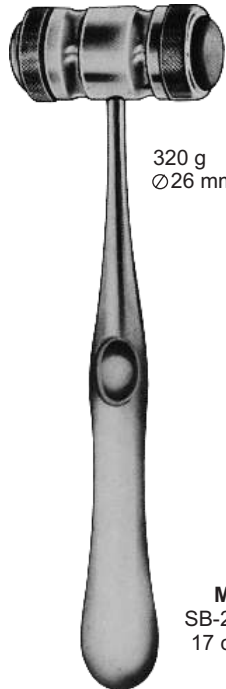

320 g  
Ø26 mm

**Mead**  
SB-2424-17  
17 cm/6¾"



**Williger**  
SB-2425-16  
16.5 cm/6½"



165 g  
Ø 22 mm

SB-2426-19  
19 cm/7½"



**Gerzog**  
SB-2427-19  
19 cm/7½"



200 g  
22 mm Ø  
(7 oz.)

**Partsch**  
SB-2428-18  
18 cm/7"

# Bone Instruments

Tendon Seizing Instruments  
Tendon ergriff Instruments

Tendon Instruments Saisir  
Aprovechar los instrumentos del tendón



**Fischer**  
SB-2429-31  
31 cm/12¼"



**Brand**

SB-2430-50  
50 cm/19½"  
6 mm Ø



SB-2431-30  
30 cm/12"  
3 mm Ø



**Brand**  
SB-2432-50  
50 cm/19½"

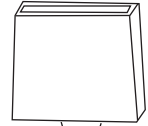

6 x 14 mm

Tendon Strippers  
Sehnen Strippers  
Décapants tendon  
Strippers tendón



mm Ø  
4.0 SB-2433-40  
4.5 SB-2433-45  
5.5 SB-2433-55

Flexible Shaft  
flexible Welle  
arbre flexible  
eje flexible

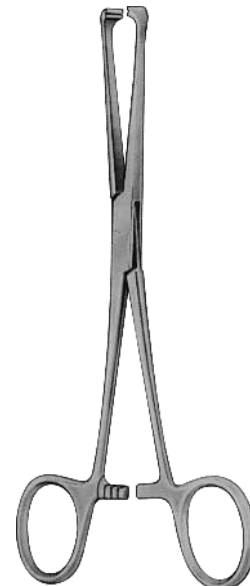

**Steinmann**  
SB-2434-50  
16 cm/6⅓"

## Bone Instruments

Tendon Seizing Instruments  
Tendon ergriff Instruments

Tendon Instruments Saisir  
Aprovechar los instrumentos del tendón

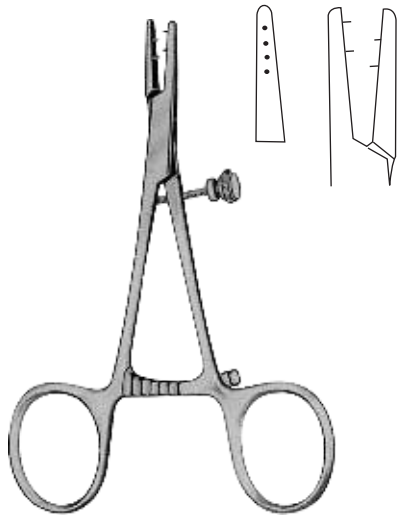

**Steinmann**  
SB-2435-13  
13 cm/5"



SB-2436-20

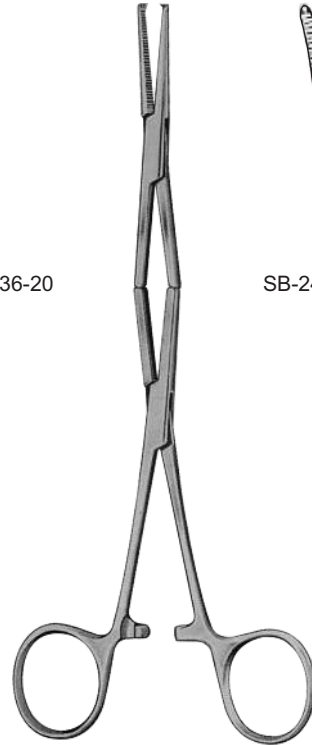

SB-2437-20

20 cm/8"



**Carroll**  
SB-2438-11  
11 cm/4½"

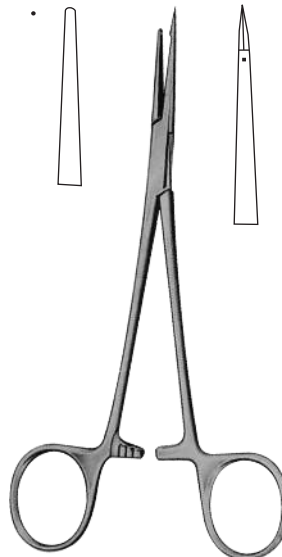
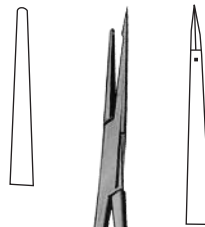

SB-2439-15  
15 cm/6"

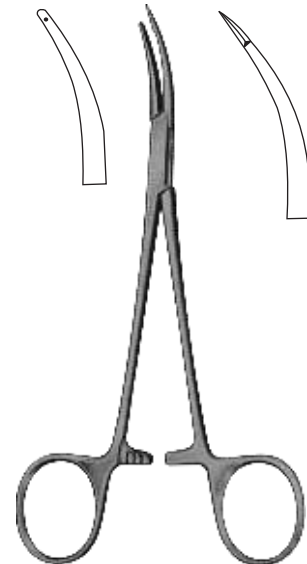
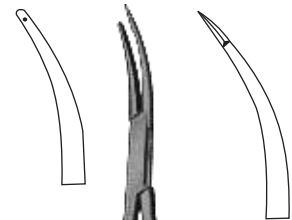

SB-2440-15  
15 cm/6"

# Bone Instruments

Tendon Seizing Instruments  
Tendon ergriff Instruments

Tendon Instruments Saisir  
Aprovechar los instrumentos del tendón



**Kleinert-Kutz**  
SB-2441-20  
16 cm/8"

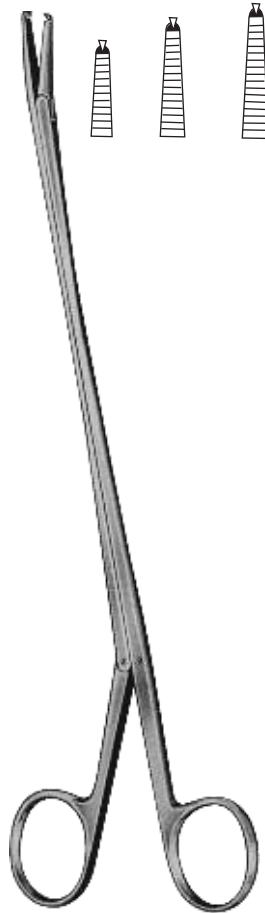

**Brand**  
SB-2442-15 16 cm/6"  
SB-2442-19 19 cm/7½"  
SB-2442-24 24 cm/9½"

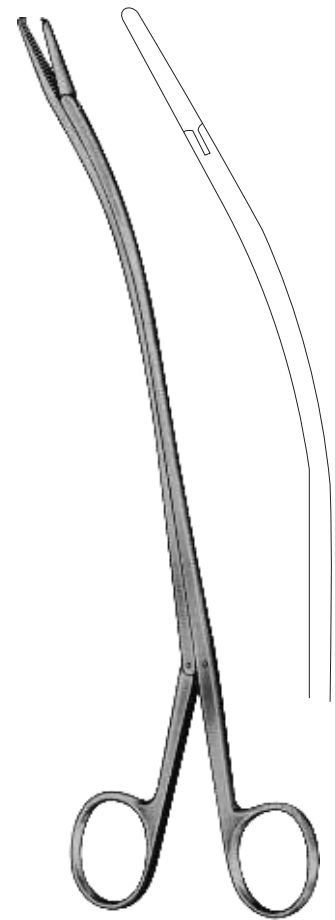

**Brand**  
SB-2443-15 16 cm/6"  
SB-2443-19 19 cm/7½"  
SB-2443-24 24 cm/9½"



*Serving Health Care*

# **SPEED BIRD**

## **ENTERPRISES**



**161/C, SMALL INDUSTRIAL ESTATE  
SIALKOT-51310, (PAKISTAN)**



**: +92-304 0549944**



**: +92-52-3555584**



**: [speed@birddent.com](mailto:speed@birddent.com)**



**: [www.birddent.com](http://www.birddent.com)**