



SPEED BIRD
ENTERPRISES

Serving Health Care

www.birddent.com

GENERAL INSTRUMENTS

SECTION

06

General Instruments

Wound and Nerve Hooks
Wund-und Nerven-Hooks

Crochets des plaies et du nerf
De la herida y los nervios Ganchos



Sharp
scharf
net
agudo
SB-1025-01

blunt
stumpf
émousser
embotar
SB-1025-02

Miller
13.5cm/5¼"



Crile
SB-1026-20
20cm/8"

Cushing

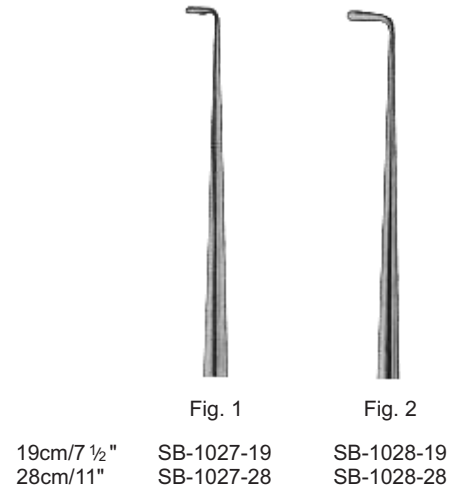

19cm/7 ½"
28cm/11"

Fig. 1
SB-1027-19
SB-1027-28

Fig. 2
SB-1028-19
SB-1028-28



Kilner
SB-1029-15
15cm/6"



Gillies
SB-1030-18
18cm/7"



Gillies
SB-1031-18
18cm/7"

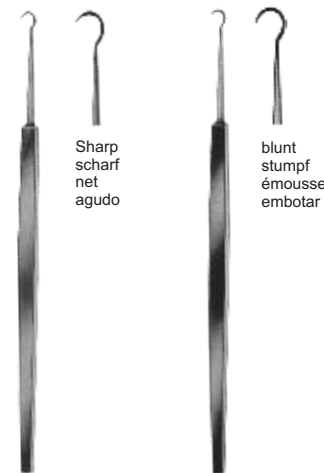

Frazier
SB-1032-13 13cm/5"
SB-1032-18 18cm/7" SB-1033-13
SB-1033-18

Sharp
scharf
net
agudo

blunt
stumpf
émousser
embotar

Fig.1

Fig.2

General Instruments

Wound and Nerve Hooks
Wund-und Nerven-Hooks

Crochets des plaies et du nerf
De la herida y los nervios Ganchos

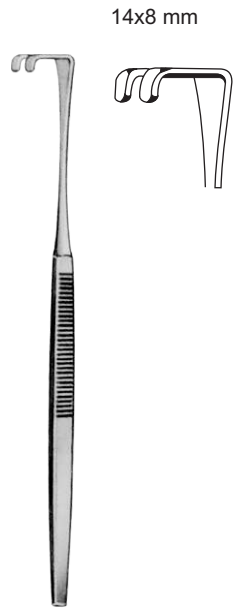

SB-1034-00
16cm/6¼"

14x8 mm

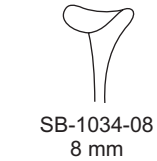

SB-1034-08
8 mm

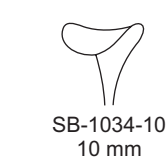

SB-1034-10
10 mm

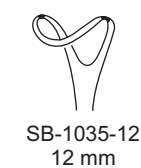

SB-1035-12
12 mm

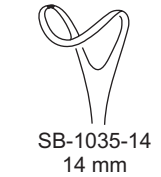

SB-1035-14
14 mm



SB-1034-12
12 mm



SB-1034-14
14 mm



SB-1035-16
16 mm

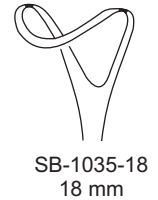

SB-1035-18
18 mm

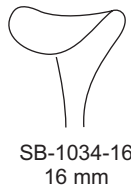

SB-1034-16
16 mm



SB-1034-18
18 mm



SB-1036-16

Sharp
scharf
net
agudo

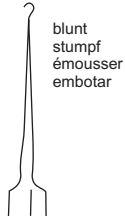

Graefe
16cm/6¼" SB-1037-16

blunt
stumpf
émousser
embotar



SB-1038-16
16cm/6¼"



SB-1039-16
16cm/6¼"



O, Connor
SB-1040-16
16cm/6¼"



SB-1041-16



Guthrie
16cm/6¼" SB-1042-16



SB-1043-16
16cm/6¼"



SB-1044-16
16cm/6¼"

General Instruments

Wound and Trachea Retractors
Wund-und Luftröhre Retraktoren

Rétracteurs plaies et de la trachée
Heridas y tráquea Retractores

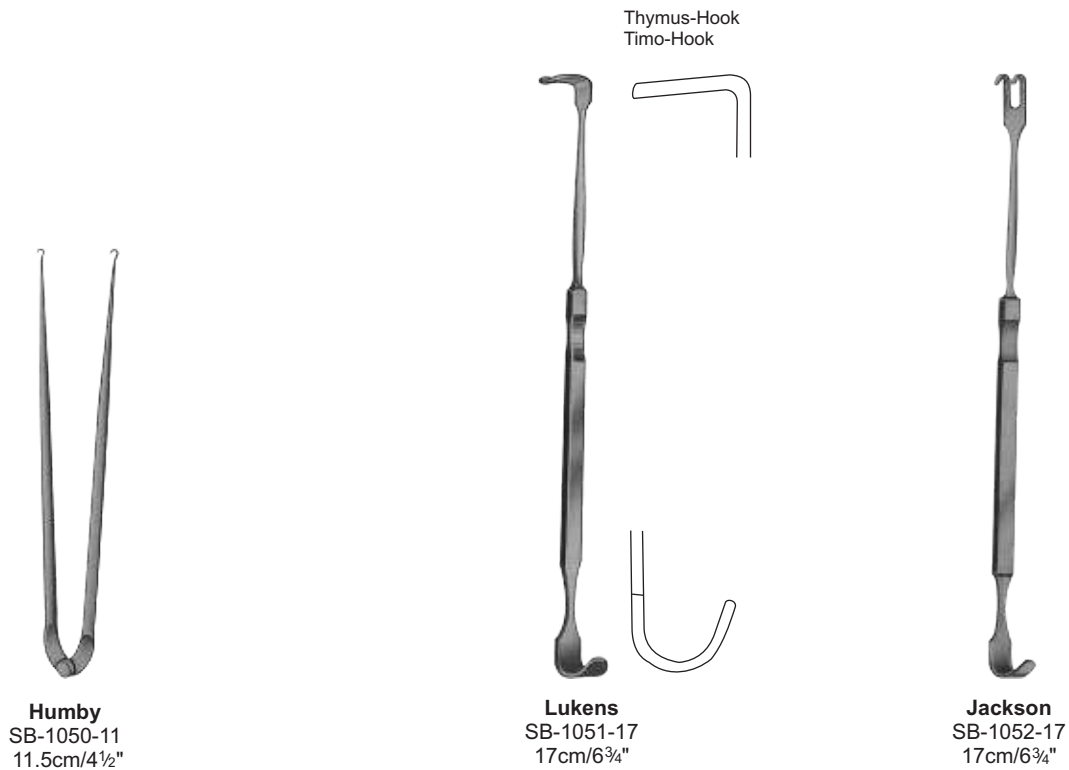
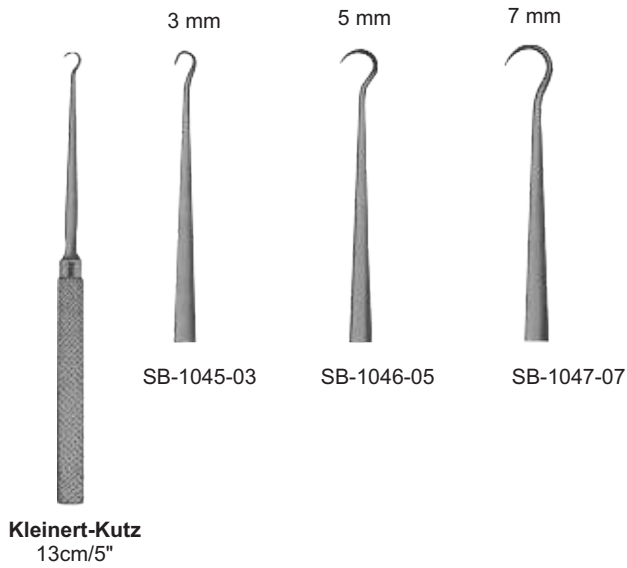

General Instruments

Retractors
Retraktoren

Rétracteurs
Retradores

Malleable
formbar
malléable
maleable

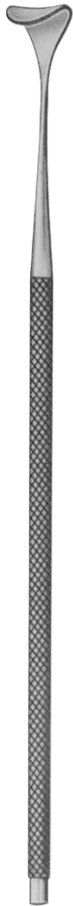

Gil-Vernet
24cm/9½"

| | |
|------------------|------------|
| 8 mm SB-1053-08 | SB-1054-08 |
| 11 mm SB-1053-11 | SB-1054-11 |
| 15 mm SB-1053-15 | SB-1054-15 |
| 17 mm SB-1053-17 | SB-1054-17 |
| 20 mm SB-1053-20 | SB-1054-20 |
| 23 mm SB-1053-23 | SB-1054-23 |

Malleable
formbar
malléable
maleable



24cm/9½"

12x14 mm



Little
SB-1055-20
20cm/8"



Love-(Morse)
25cm/10"

| |
|------------------|
| 10 mm SB-1056-10 |
| 15 mm SB-1056-15 |
| 20 mm SB-1056-20 |
| 30 mm SB-1056-30 |
| 40 mm SB-1056-40 |
| 50 mm SB-1056-50 |

General Instruments

Wound and Trachea Retractors
Wund- und Luftröhre Retraktoren

Rétracteurs plaies et de la trachée
Heridas y tráquea Retractores

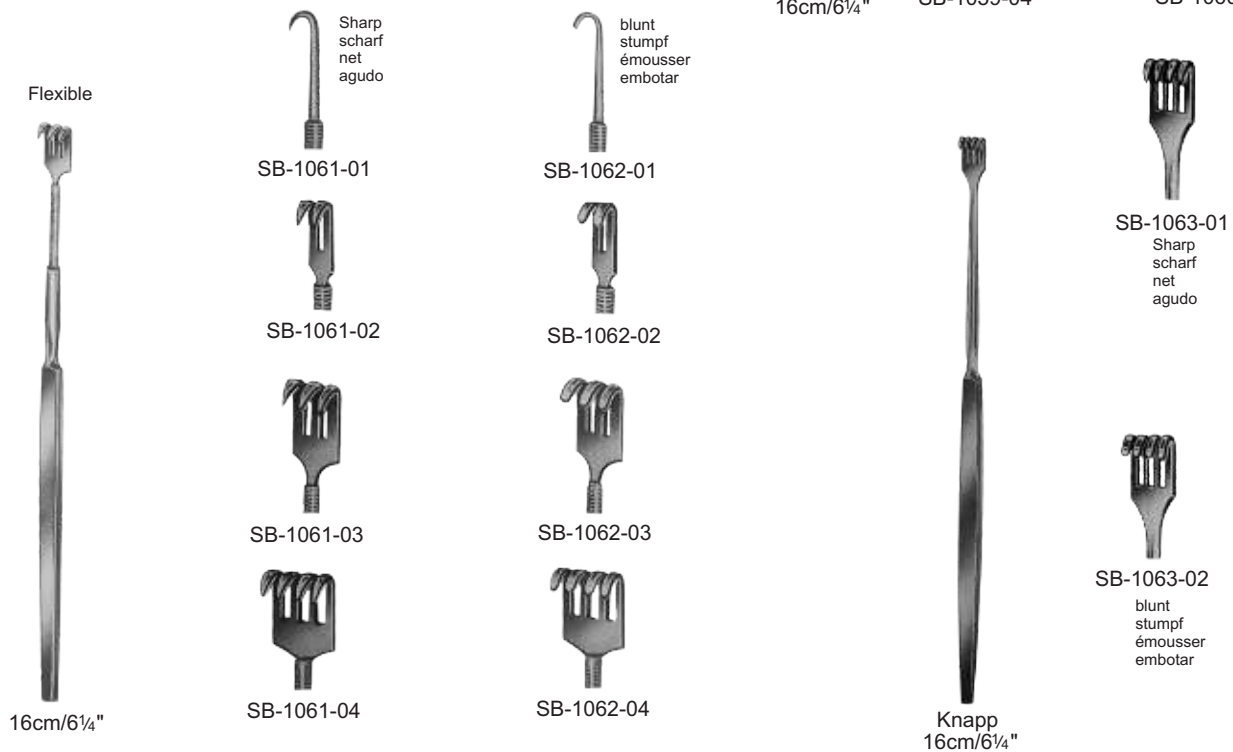
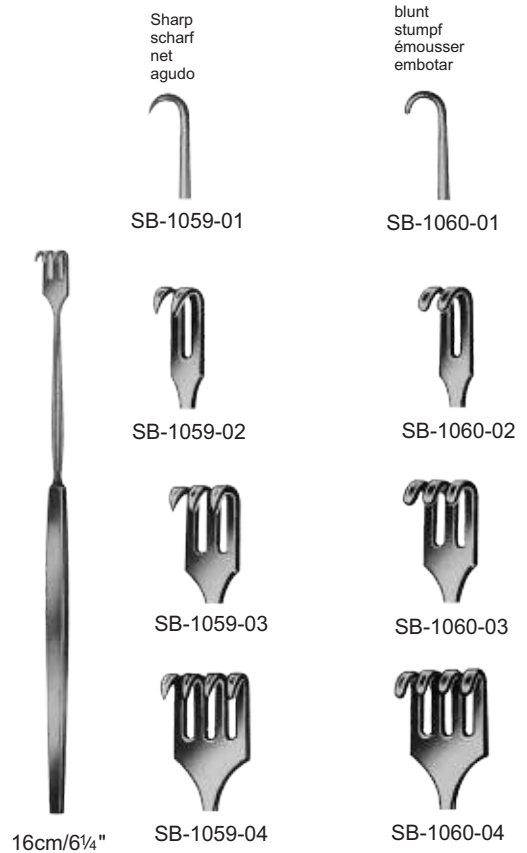

General Instruments

Trachea Retractors
Trachea Retraktoren

Rétracteurs trachée
tráquea Retractores



SB-1064-13
13.5cm/5¼"



Jackson
SB-1065-13
13cm/5"



Bergmann
SB-1066-14
14cm/5½"



Iterson
16cm/6¼"



SB-1067-16



SB-1067-16



Meyerding
18cm/7"



SB-1068-18
18x7 mm



SB-1071-18
16x5 mm



SB-1069-18
7x4 mm



SB-1072-18
10x3 mm



SB-1070-18
7x4 mm



SB-1073-18



Volkman
11.5cm/4½"



Sharp
scharf
net
agudo

SB-1074-02



blunt
stumpf
émousser
embotar

SB-1075-02



SB-1074-03



SB-1075-03



SB-1074-04



SB-1075-04



SB-1074-06



SB-1075-06

General Instruments

Wound and Vein Retractors
Wund-und Vein Retraktoren

Rétracteurs plaies et de la veine
Heridas y Vena Retractores

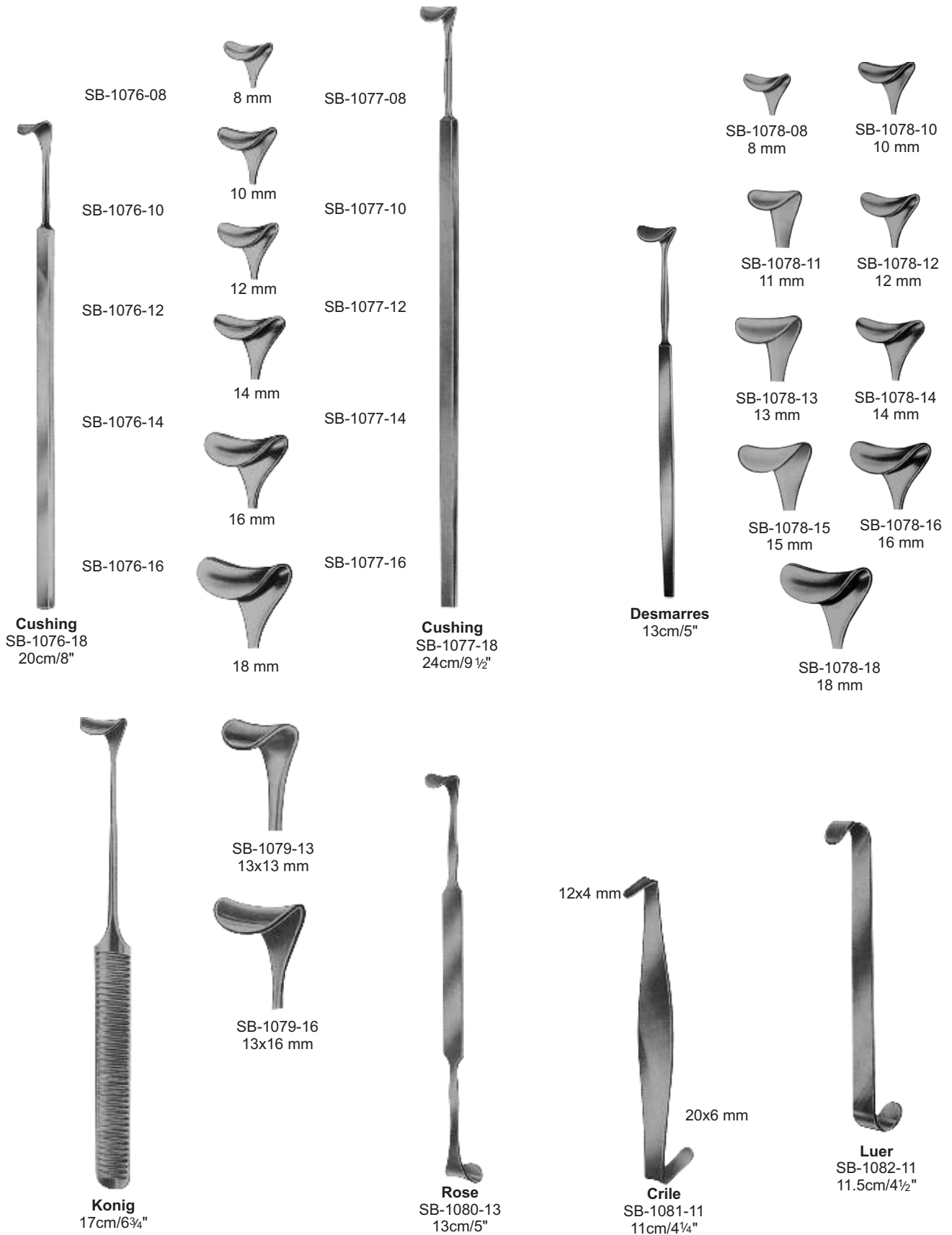

General Instruments

Retractors
Retraktoren

Rétracteurs
Retradores

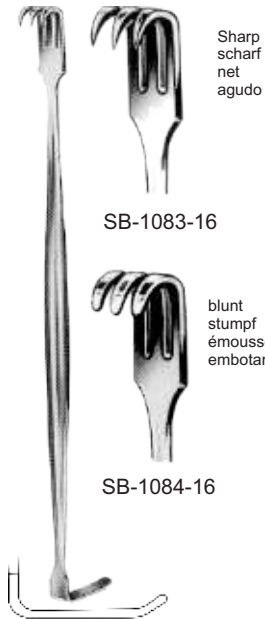

Senn-Miller
16cm/6¼"

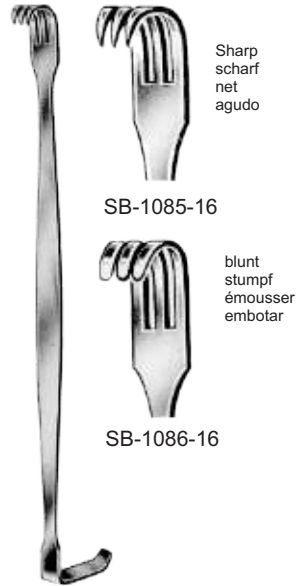

Baby-Senn-Miller
16cm/6¼"



Rangell-Davis
SB-1087-14
14cm/5½"



Senn-Green
15cm/6"

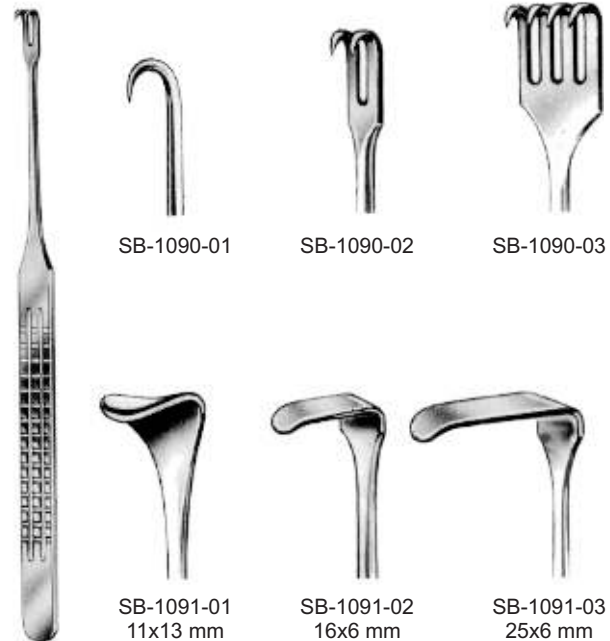

Langenbeck-Green
16cm/6¼"

General Instruments

Retractors and Tendon Sheath Hooks
Reaktoren und Sehnenscheide Haken

Rétracteurs et Crochets gaine du tendon
Los retractoros y ganchos la vaina del tendón

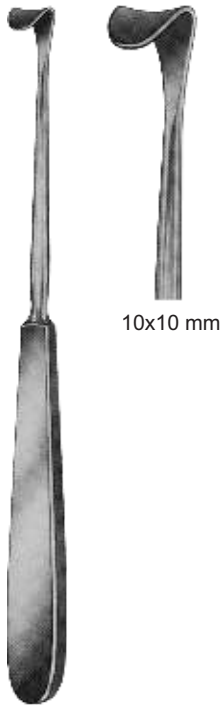

10x10 mm

Cushing-Kocher
SB-1092-18
18cm/7"

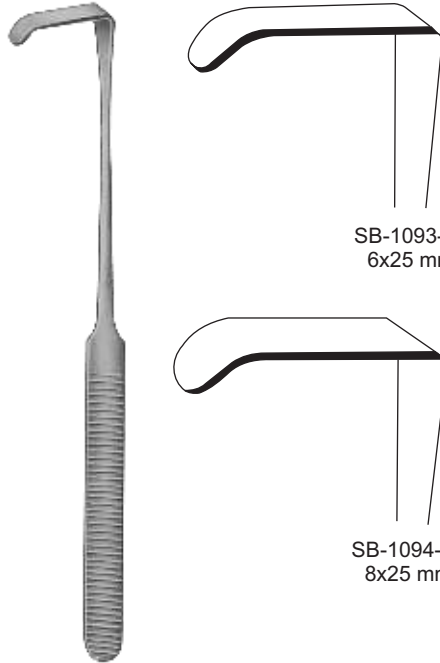

SB-1093-17
6x25 mm

SB-1094-17
8x25 mm

Langenbeck-Green
17cm/6¾"



Tendon Sheath Hook
Sehnenscheide Haken
Crochet gaine du tendon
Hook vaina del tendón



SB-1095-19



SB-1096-19

Strandell-Stille
19cm/7½"

Tendon Sheath Hook
Sehnenscheide Haken
Crochet gaine du tendon
Hook vaina del tendón



Klapp
17.5 cm/7"



SB-1097-01



SB-1097-02



SB-1097-03



Decompression Hook
Decompression Haken
Crochet de décompression
descompresión Hook

Cushing
SB-1098-20
20cm/8"

General Instruments

Retractors
Retraktoren

Rétracteurs
Retradores



Collin-Hartmann

| | |
|-----------|------------|
| Set | SB-1099-00 |
| 14 cm/5½" | SB-1099-01 |
| 16 cm/6" | SB-1099-02 |

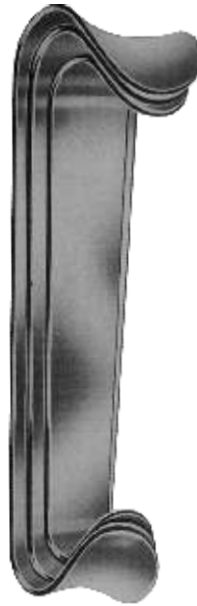

Roux

| | |
|-----------|------------|
| Set | SB-1100-00 |
| 14 cm/5½" | Fig. 1 |
| 15 cm/6" | Fig. 2 |
| 17 cm/6¾" | Fig. 3 |



Baby-Roux
13 cm/5"

SB-1101-13



Mini-Roux
14 cm/5½"

SB-1102-14

37x40 mm



37x31 mm

Goelet
SB-1103-19
19 cm/7½"



**Parker-Langenbeck
(US-Army)**
SB-1104-21
21cm/8¼"

Set
setzen
fixer
establecer



Parker
SB-1105-13
13.5 cm/5¼"

Set
setzen
fixer
establecer



Parker
SB-1106-18
18 cm/7"

Set
setzen
fixer
establecer

General Instruments

Retractors
Reaktoren

Rétracteurs
Retradores

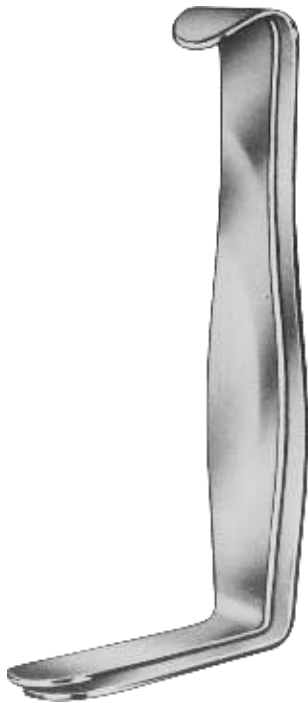

Parker-Mott
SB-1107-16
16 cm/6¼"

Set
setzen
fixer
establecer



Farabeuf
SB-1108-12
12 cm/4 "

Set
setzen
fixer
establecer



Farabeuf
SB-1109-15
15 cm/6"

Set
setzen
fixer
establecer



Farabeuf
SB-1110-01
8x10x100mm
SB-1110-02
7x9x120mm
SB-1110-03
11x14x120mm
SB-1110-04
11x15x150mm
SB-1110-05
21x15x150mm



Collin
SB-1111-16
16.5 cm/6½"

Set
setzen
fixer
establecer



Mayo-Collin
SB-1112-15
15 cm/6"

Set
setzen
fixer
establecer



Mathieu
SB-1113-19
19 cm/7½"

Set
setzen
fixer
establecer

General Instruments

Retractors and Bone Retractors
Retraktoren und Bone Retraktoren

Rétracteurs et écarteurs à os
Separadores y Retractores hueso



Sharp
scharf
net
agudo



blunt
stumpf
émousser
embotar



Sharp
scharf
net
agudo



blunt
stumpf
émousser
embotar



Volkman
SB-1113-22
22 cm/8 3/4"

Volkman
SB-1114-22
22 cm/8 3/4"

SB-1115-23
23 cm/9"

SB-1116-23
23 cm/9"

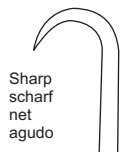

Sharp
scharf
net
agudo

SB-1117-01



SB-1117-02



SB-1117-03



SB-1117-04



SB-1117-06



SB-1117-08

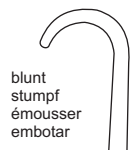

blunt
stumpf
émousser
embotar

SB-1118-01



SB-1118-02



SB-1118-03



SB-1118-04



SB-1118-06



SB-1118-08

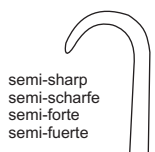

semi-sharp
semi-scharfe
semi-forte
semi-fuerte

SB-1119-01



SB-1119-02



SB-1119-03



SB-1119-04



SB-1119-06



SB-1119-08

Volkman
21,5cm/8 1/2"

General Instruments

Retractors and Bone Retractors
Retraktoren und Bone Retraktoren

Rétracteurs et écarteurs à os
Separadores y Retractores hueso



Volkman
21 cm/8³/₄"

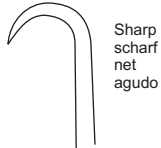

Sharp
scharf
net
agudo

SB-1120-01



SB-1120-02



SB-1120-03



SB-1120-04



SB-1120-06

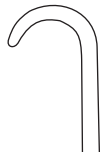

blunt
stumpf
émousser
embotar

SB-1121-01



SB-1121-02



SB-1121-03



SB-1121-04



SB-1121-06

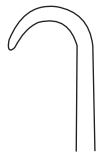

semi-sharp
semi-scharfe
semi-forte
semi-fuerte

SB-1122-01



SB-1122-02



SB-1122-03



SB-1122-04



SB-1122-06

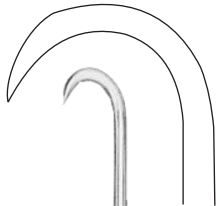

Sharp
scharf
net
agudo

SB-1123-24
24.5 cm/9³/₄"



Sharp
scharf
net
agudo

Kocher
SB-1124-21
21.5 cm/8¹/₂"

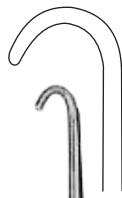

blunt
stumpf
émousser
embotar

Kocher
SB-1125-21
21.5 cm/8¹/₂"

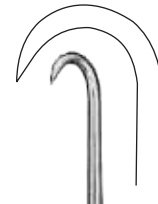

Sharp
scharf
net
agudo

Kocher
SB-1126-21
21.5 cm/8¹/₂"

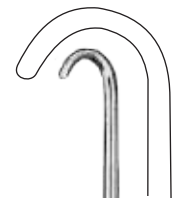

blunt
stumpf
émousser
embotar

Kocher
SB-1127-21
21.5 cm/8¹/₂"

General Instruments

Retractors and Bone Retractors
Retraktoren und Bone Retraktoren

Rétracteurs et écarteurs à os
Separadores y Retractores hueso



Kocher
22 cm/8³/₄"

Sharp
scharf
net
agudo

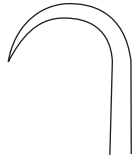

SB-1128-01



SB-1128-02



SB-1128-03



SB-1128-04



SB-1128-06



SB-1128-08

blunt
stumpf
émousser
embotar

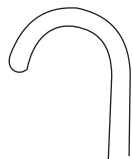

SB-1129-01



SB-1129-02



SB-1129-03



SB-1129-04



SB-1129-06



SB-1129-08

semi-sharp
semi-scharfe
semi-forte
semi-fuerte

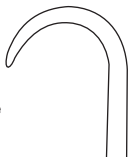

SB-1130-01



SB-1130-02



SB-1130-03



SB-1130-04



SB-1130-06



SB-1130-08

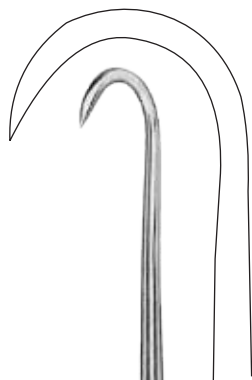

Sharp
scharf
net
agudo

SB-1131-20
20 cm/8"

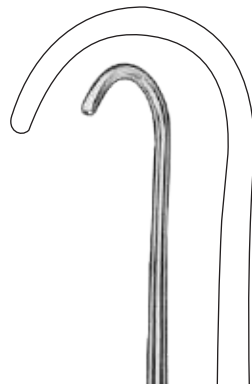

blunt
stumpf
émousser
embotar

SB-1132-20
20 cm/8"

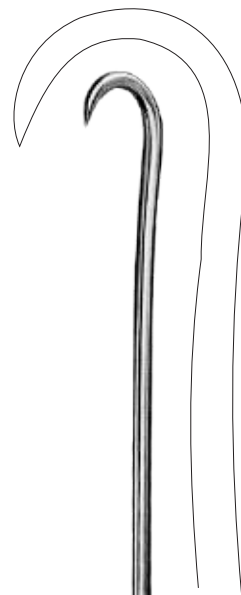

Sharp
scharf
net
agudo

SB-1133-14
14 cm/5¹/₂"

General Instruments

Retractors
Retraktoren

Rétracteurs
Retradores

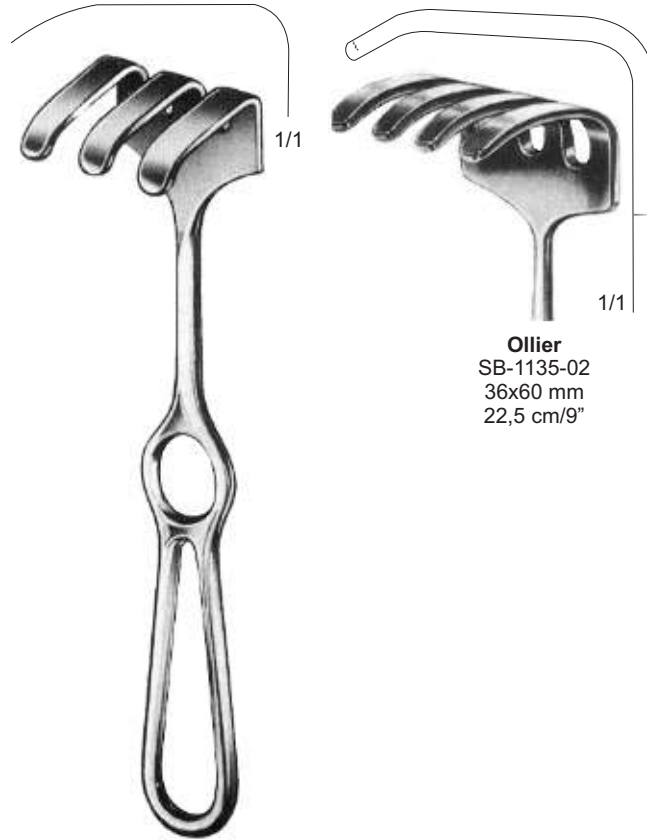

Ollier
SB-1135-02
36x60 mm
22,5 cm/9"

Ollier
SB-1134-01
36x30 mm
22,5 cm/9"



Murphy
19.5 cm/7 3/4"

Sharp
scharf
net
agudo



SB-1136-02



SB-1136-03



SB-1136-04



SB-1136-06

blunt
stumpf
émousser
embotar

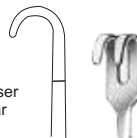

SB-1137-02



SB-1137-03



SB-1137-04



SB-1137-06

General Instruments

Retractors
Retraktoren

Rétracteurs
Retradores



33x20 mm

Wassmund
SB-1138-20
20cm/8"



SB-1139-02
40x50 mm

Israel
25cm/10"



SB-1139-01
40x40 mm



SB-1139-03
50x60 mm



SB-1139-04
70x70 mm



46x55 mm

Koerte
23cm/9"

Vertical Handle
vertikale Griff
poignée verticale
asa vertical
SB-1140-23

General Instruments

Retractors
Retraktoren

Rétracteurs
Retractoros



Koerte-Wagner
SB-1141-28
28cm/11"



Koerte
23.5 cm/9 1/4"

40x30 mm

Vertical Handle
vertikale Griff
poignée verticale
asa vertical



blunt
stumpf
émousser
embotar
SB-1143-23

Sharp
scharf
net
agudo
SB-1142-23



SB-1144-24
24cm/9 1/2"

Vertical Handle
vertikale Griff
poignée verticale
asa vertical

50x25 mm



SB-1145-25
25cm/10"

General Instruments

Retractors
Retraktoren

Rétracteurs
Retradores



Langenbeck

SB-1146-01 22x6mm 21.5cm/8½"
SB-1146-02 44x13mm 21.5cm/8½"
SB-1146-03 64x25mm 21.5cm/8½"



Langenbeck

21cm/8¼"

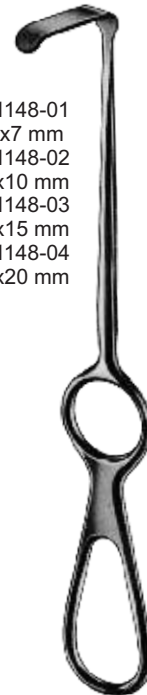

Langenbeck

21cm/8¼"



Lahey

SB-1149-19
28x6 mm



22.5cm

Sauerbruch

SB-1150-01 45x15 mm
SB-1150-02 60x23 mm
SB-1150-03 75x20 mm



Langenbeck

21cm/8¼"

SB-1151-01 30x11 mm SB-1151A-01
SB-1151-02 30x14 mm SB-1151A-02
SB-1151-03 33x14 mm
SB-1151-04 30x16 mm SB-1151A-04
SB-1151-05 40x11 mm SB-1151A-05
SB-1151-06 42x13 mm
SB-1151-07 50x11 mm SB-1151A-07



Langenbeck

22cm/8¾"

General Instruments

Retractors
Retraktoren

Rétracteurs
Retractoros

SB-1152-01 40x10 mm
SB-1152-02 40x15 mm
SB-1152-03 40x20 mm



Kocher
22cm/8¾"

SB-1153-01
19x12 mm
SB-1153-02
21x15 mm



Kocher
19cm/7½"

SB-1154-01 25x06 mm
SB-1154-02 25x08 mm
SB-1154-03 35x08 mm
SB-1154-04 35x11 mm
SB-1154-05 35x15 mm
SB-1154-06 42x11 mm
SB-1154-07 55x11 mm
SB-1154-08 70x14 mm
SB-1154-09 80x12 mm
SB-1154-10 80x16 mm

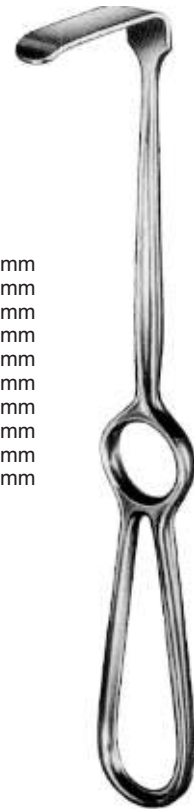

Kocher-Langenbeck
21.5cm/8½"



Czerny
SB-1155-18
18 cm/7"

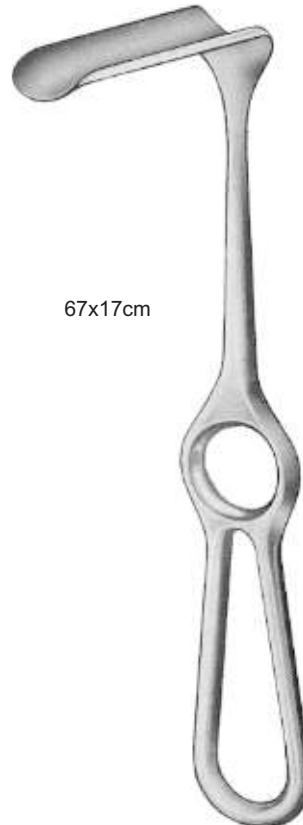

67x17cm

Casper
SB-1156-21
21.5cm/8½"

General Instruments

Retractors
Retraktoren

Rétracteurs
Retradores

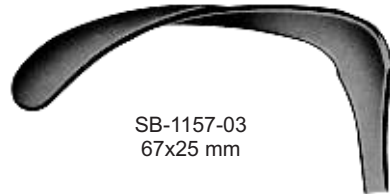

SB-1157-03
67x25 mm



SB-1157-01
22x15 mm

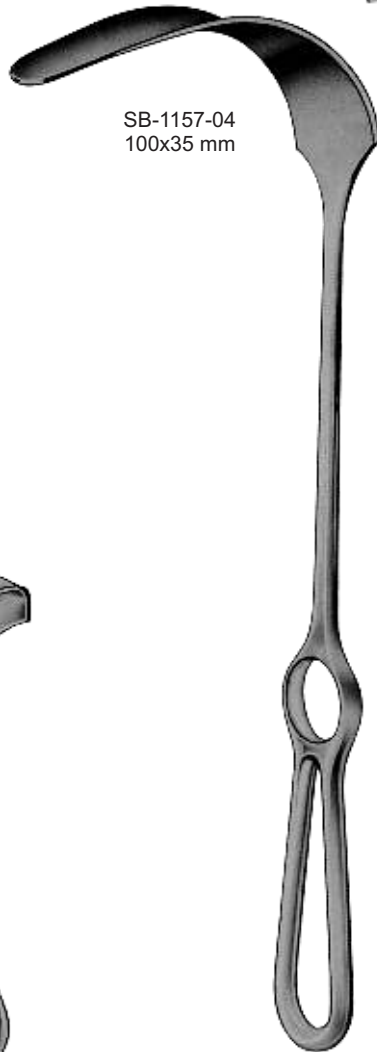

SB-1157-04
100x35 mm

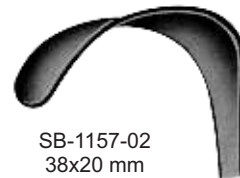

SB-1157-02
38x20 mm



SB-1158-01
40x18 mm
SB-1158-02
60x20 mm
SB-1158-03
60x25 mm
SB-1158-04
75x30 mm
SB-1158-05
75x40 mm

Kocher
23cm/9"

Kocher-Wagner
28cm/11"

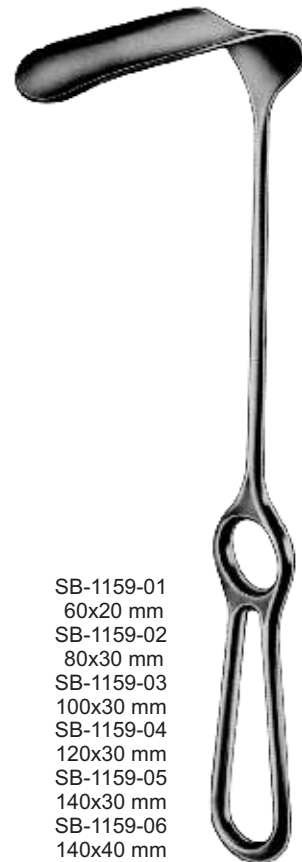

SB-1159-01
60x20 mm
SB-1159-02
80x30 mm
SB-1159-03
100x30 mm
SB-1159-04
120x30 mm
SB-1159-05
140x30 mm
SB-1159-06
140x40 mm

Heosel
25cm/10"

General Instruments

Retractors
Retraktoren

Rétracteurs
Retradores

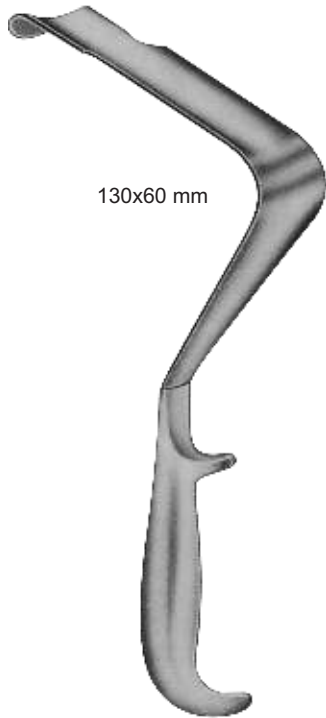

130x60 mm

St. Marks
SB-1161-29
29cm/11½"

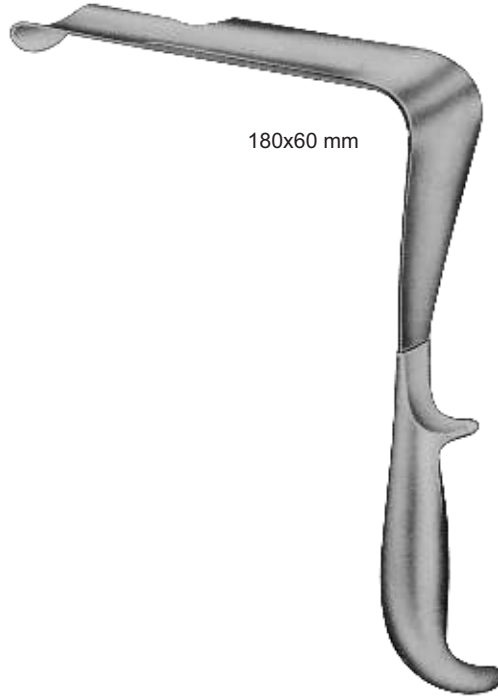

180x60 mm

St. Marks
SB-1162-32
32.5cm/12¾"

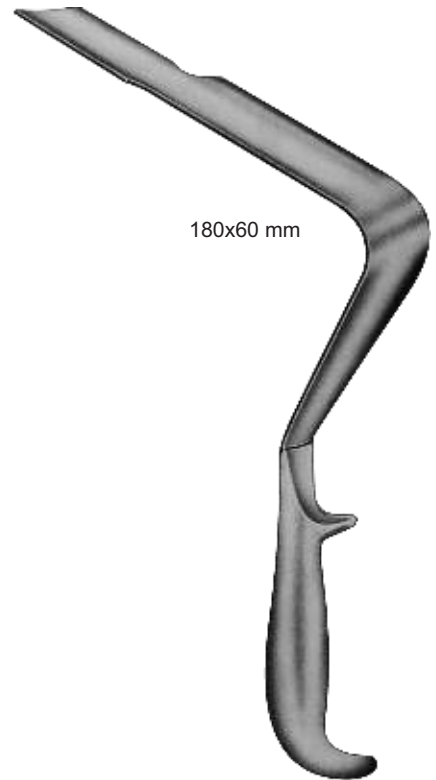

180x60 mm

St. Marks
SB-1163-33
33cm/13"



SB-1164-01
70x40 mm
SB-1164-02
70x50 mm
SB-1164-03
70x65 mm

Morris
21cm/8¼"



SB-1165-01
32x50 mm/38x50mm
SB-1165-02
45x50 mm/50x50mm
SB-1165-03
65x50 mm/38x50mm

Morris
24cm/9½"

General Instruments

Retractors and Meniscus Retractors
Retraktoren und Meniskus Retraktoren

Rétracteurs Rétracteurs et méniscales
Separadores y Retractores de menisco



Meniscus Retractors
Ecarteurs ménisque
Retradores de menisco

38x9 mm

SB-1166-21
21cm/8¼"



40x5 mm

Blunt
SB-1167-18
18cm/7"

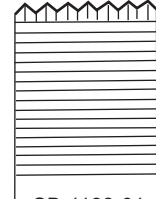

SB-1168-01
15x15 mm

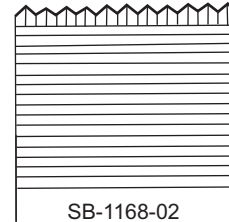

SB-1168-02
15x23 mm

Crawford
19cm/7½"



Green
SB-1169-22
22cm/8½"



Middeldorpf

SB-1170-01



14x17 mm
21.5cm/8½"

SB-1171-01

SB-1170-02



SB-1170-03



26x30 mm
23.5cm/9¼"

SB-1171-02

SB-1171-03



Middeldorpf

General Instruments

Retractors
Retraktoren

Rétracteurs
Retradores

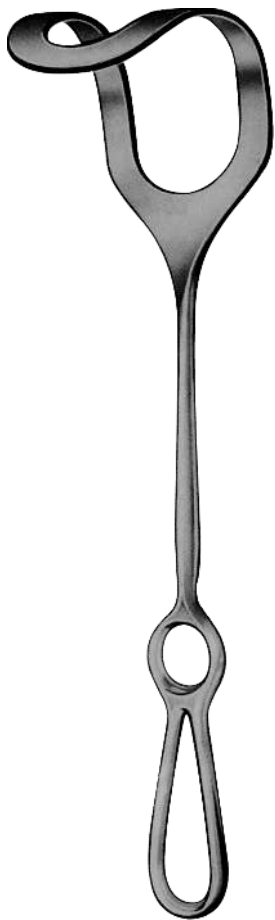

Middeldorpf
25.5cm/10"

SB-1172-01
45x45 mm
SB-1172-02
45x50 mm
SB-1172-03
55x70 mm



Richardson
26cm/10¼"



SB-1173-01
28x20 mm



SB-1173-02
36x28 mm



SB-1173-03
44x38 mm



SB-1173-04
52x22 mm

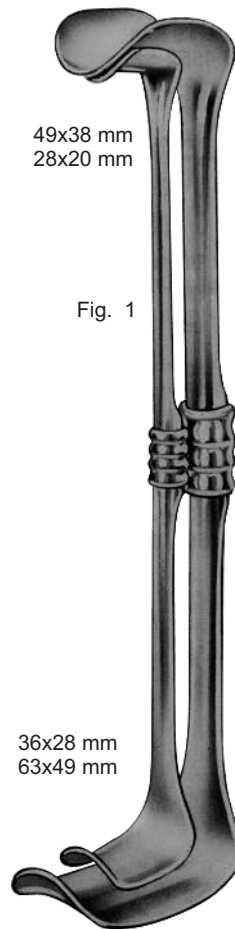

49x38 mm
28x20 mm

Fig. 1

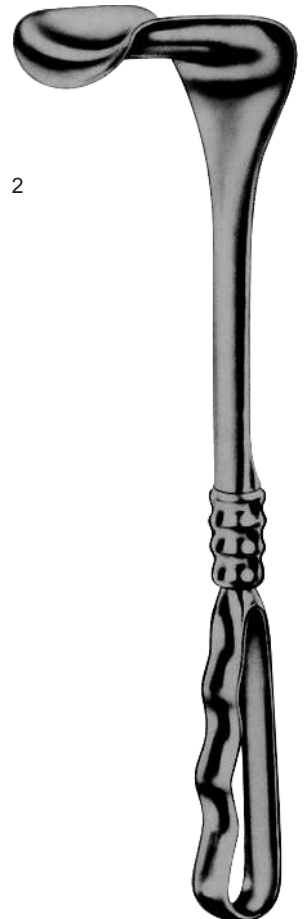

Fig. 2

36x28 mm
63x49 mm

Richardson-Eastman

Set
setzen SB-1174-00
fixer
establecer

Fig. 1
26cm/10¼" SB-1174-01

Fig. 2
28cm/11" SB-1174-02

Kelly
26cm/10¼"

SB-1175-01
40x50 mm
SB-1175-02
50x65 mm
SB-1175-03
65x75 mm
SB-1175-04
75x90 mm

General Instruments

Retractors
Retraktoren

Rétracteurs
Retradores

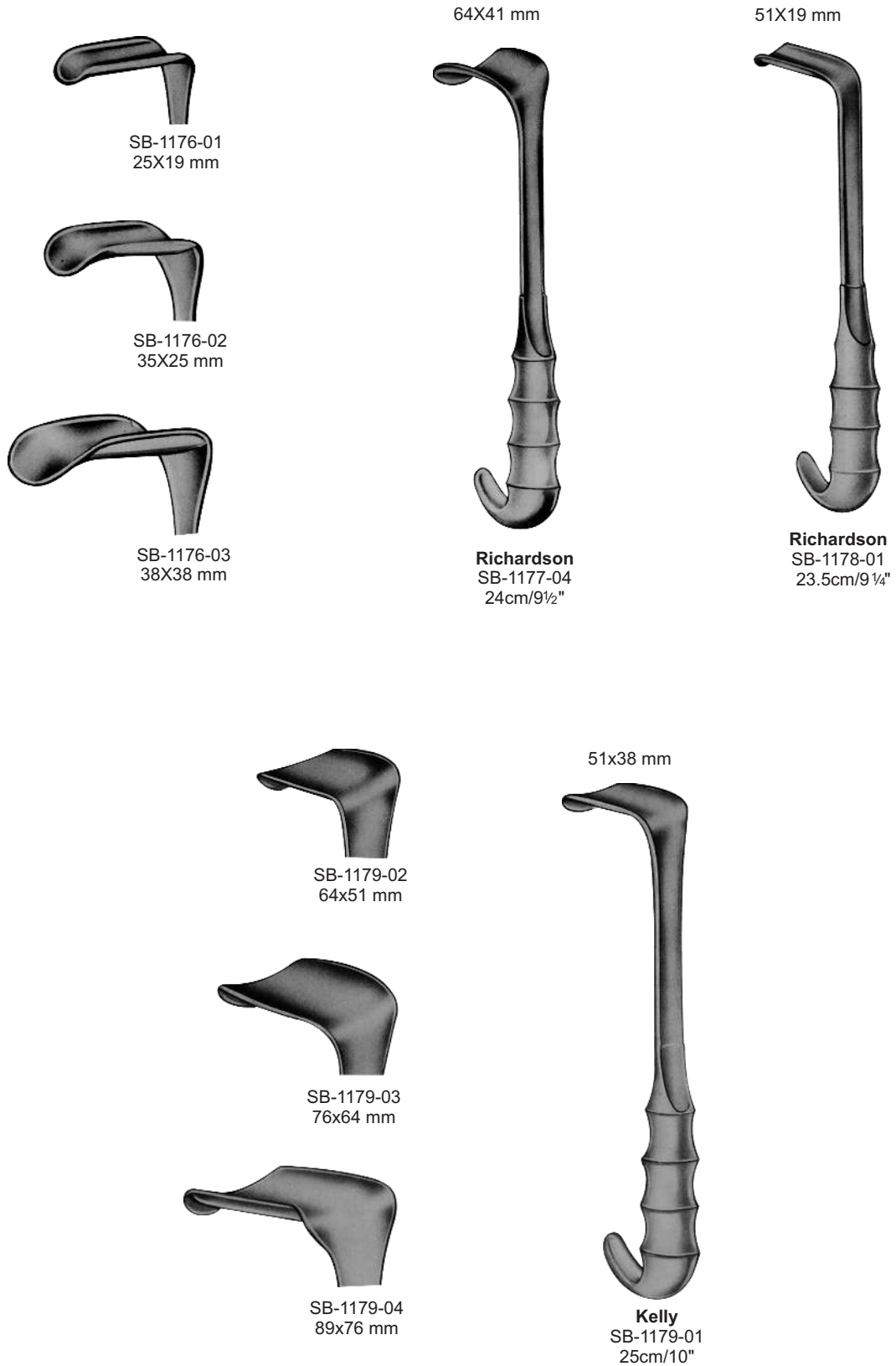

General Instruments

Retractors
Retraktoren

Rétracteurs
Retractors



SB-1180-01
40x40 mm
SB-1180-02
45x40 mm
SB-1180-03
45x50 mm
SB-1180-04
45x60 mm
SB-1180-05
45x75 mm
SB-1180-06
65x85 mm

Fritsch
24cm/9½"



50x85 mm

Doyen
SB-1181-25
25cm/10"

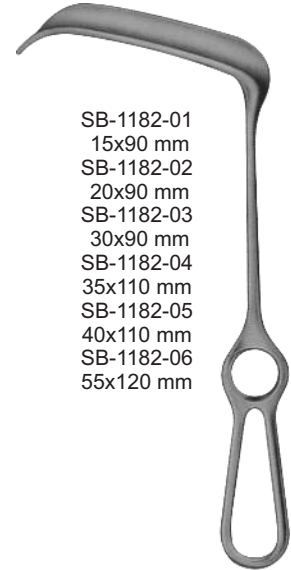

SB-1182-01
15x90 mm
SB-1182-02
20x90 mm
SB-1182-03
30x90 mm
SB-1182-04
35x110 mm
SB-1182-05
40x110 mm
SB-1182-06
55x120 mm

Doyen-Stille
24cm/9½"



70x25 mm

Kocher
SB-1183-22
22.5cm/9"



SB-1184-01
80x45 mm
SB-1184-02
80x55 mm
SB-1184-03
80x65 mm

Kocher
25cm/10"



64x60 mm

Tuffier
SB-1185-23
23cm/9"

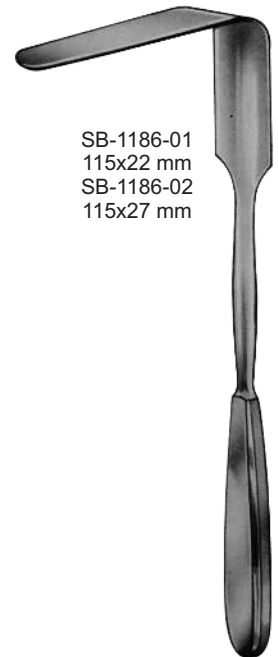

SB-1186-01
115x22 mm
SB-1186-02
115x27 mm

Simon
28cm/11"

General Instruments

Retractors and Liver Retractors
Retraktoren und Leber Retraktoren

Rétracteurs Rétracteurs et du foie
Separadores y Retractores hepáticos



95x20 mm

Tuebingen
SB-1187-28
28cm/11"



105x27 mm

Martin
SB-1188-26
26cm/10¼"

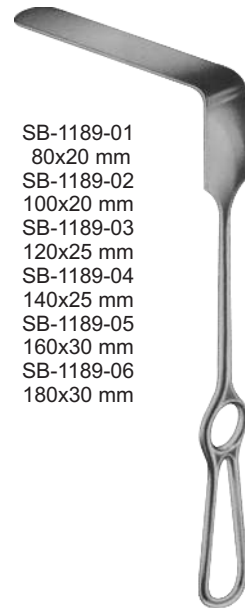

SB-1189-01
80x20 mm
SB-1189-02
100x20 mm
SB-1189-03
120x25 mm
SB-1189-04
140x25 mm
SB-1189-05
160x30 mm
SB-1189-06
180x30 mm

Brunner
25cm/10"



SB-1190-01
80x20 mm
SB-1190-02
100x20 mm
SB-1190-03
120x25 mm
SB-1190-04
140x25 mm
SB-1190-05
160x30 mm
SB-1190-06
180x30 mm

Brunner
25cm/10"



90x50 mm

SB-1191-01
95x35 mm
SB-1191-02
120x50 mm
SB-1191-03
155x50 mm

Mikulicz
26cm/10¼"



90x50 mm

Mikulicz
SB-1192-26
26cm/10¼"

General Instruments

Retractors
Retraktoren

Rétracteurs
Retradores



SB-1193-01
160x38 mm
SB-1193-02
160x57 mm
SB-1193-01
190x38 mm
SB-1193-02
190x57 mm

Kelly
27cm/10½"



Polloson
SB-1194-27
27cm/10½"



Polloson
SB-1195-27
27cm/10½"



SB-1196-03
115x65 mm

SB-1196-02
108x43 mm

SB-1196-01
82x22 mm

Coryllos
23.0cm/9"



SB-1197-25
125x37 mm

Sauerbruch
25cm/10"

General Instruments

Retractors and Lung Spatulas

Retraktoren und Lungenforschung Spatel

Rétracteurs Spatules et du poumon

Los retractoros y espátulas de pulmón

19 mm



Deaver
SB-1198-01
18 cm/7"

22 mm



Deaver
SB-1199-02
21.5 cm/8½"

25 mm

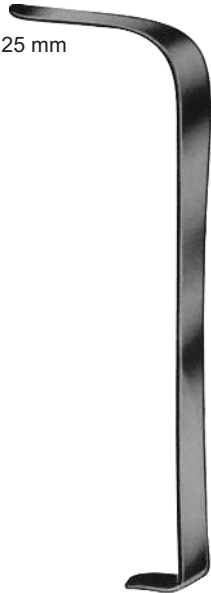

Deaver
SB-1200-03
23 cm/9"

25 mm



Deaver
SB-1201-04 30cm/12"
SB-1201-05 33cm/13"
SB-1201-06 36cm/14"



SB-1202-07
38 mm
SB-1202-08
50 mm
SB-1202-09
75 mm

Deaver
30 cm/12"



Deaver Grip-Handle
SB-1203-01 25 mm
SB-1203-02 38 mm
SB-1203-03 50 mm
SB-1203-04 75 mm
30 cm/12"



Harrington-Baby
SB-1204-01
25 cm/10"
24x70 mm
Harrington
SB-1204-02
SB-1204-03
32 cm/12½"
40x127 mm
62x127 mm
Harrington
SB-1204-04
29.5 cm/11½"
64x175 mm

General Instruments

Retractors
Retraktoren

Rétracteurs
Retradores



Meyerding

SB-1205-01
50x16 mm 20cm/8"
SB-1205-02
75x25 mm 22cm/8¾"
SB-1205-03
90x50 mm 24cm/9½"

Zenker

SB-1206-01 25cm/10" 35x08 mm
SB-1206-02 26cm10¼" 60x12 mm
SB-1206-03 27.5cm/10¾" 75x12 mm



Hibbs
24cm/9½"

SB-1207-00
Set of 2
Fig. 1
SB-1207-01
25x75 mm
Fig. 2
SB-1207-02
25x80 mm

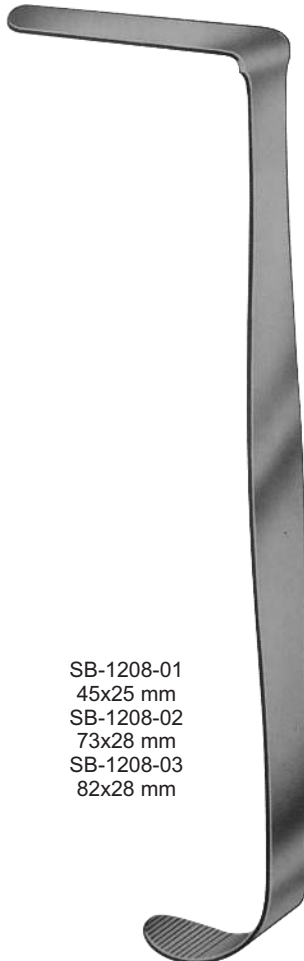

SB-1208-01
45x25 mm
SB-1208-02
73x28 mm
SB-1208-03
82x28 mm

Heaney
27cm/10½"

46 mm



Kuemmel
SB-1209-33
33cm/13"

120x47 mm

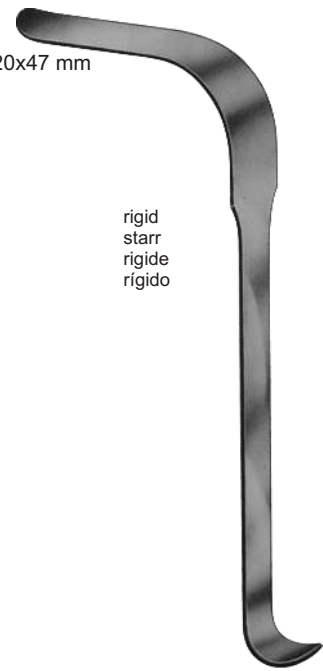

rigid
starr
rigide
rigido

Koerte
SB-1210-28
28cm/11"

General Instruments

Abdominal and Intestinal Spatulas
Bauch-und Darm-Spatel

Spatules abdominale et intestinale
Espátulas abdominales e intestinales



Kader
SB-1211-01 20mm
SB-1211-02 30mm
SB-1211-03 40mm
27cm/10 1/2"



SB-1212-01
25.5cm/10"
45 mm
SB-1212-02
27.5cm/10 3/4"
60 mm

Leriche



Malleable
formbar
malléable
maleable

SB-1213-01 20 mm
SB-1213-02 25 mm
SB-1213-03 30 mm
SB-1213-04 35 mm
SB-1213-05 40 mm
SB-1213-06 45 mm
SB-1213-07 50 mm
SB-1213-08 64 mm
SB-1213-09 76 mm
SB-1213-10 102 mm
33cm/13"

Malleable
formbar
malléable
maleable



Malleable
formbar
malléable
maleable

SB-1215-01
200x6 mm
SB-1215-02
200x8 mm
SB-1215-03
200x10 mm
SB-1215-04
200x12 mm
SB-1215-05
200x17 mm
SB-1215-06
200x20 mm
SB-1215-07
200x25 mm
SB-1215-08
250x25 mm

Tuffier
SB-1214-20
20 cm/8"
17x25 mm



20cm/8"

Malleable
formbar
malléable
maleable

SB-1216-01
280x25/30 mm
SB-1216-02
300x37/45 mm
SB-1216-03
300x40/50 mm



Haberer



Reverdin
SB-1217-28
28 cm/11"

General Instruments

Retractors
Retraktoren

Rétracteurs
Retractors



Davidson
16cm/6¼"

75x50 mm
75x90 mm

SB-1218-01
SB-1218-02



Cooley
SB-1219-01
21.5cm/8½"



Cooley
SB-1220-01
21.5cm/8½"



Cooley
SB-1221-02
23cm/9"



Ross
27cm/10½"

- Fig. 1 SB-1222-01 13x13 mm
- Fig. 2 SB-1222-02 14x12 mm
- Fig. 3 SB-1222-03 18x18 mm
- Fig. 4 SB-1222-04 20x20 mm
- Fig. 5 SB-1222-05 22x18 mm
- Fig. 6 SB-1222-06 26x24 mm

General Instruments

Retractors for Maxillofacial Surgery

Retraktoren für Kiefer-und Gesichtschirurgie

Rétracteurs pour la chirurgie maxillo-faciale

Los retractoros para cirugía maxilofacial

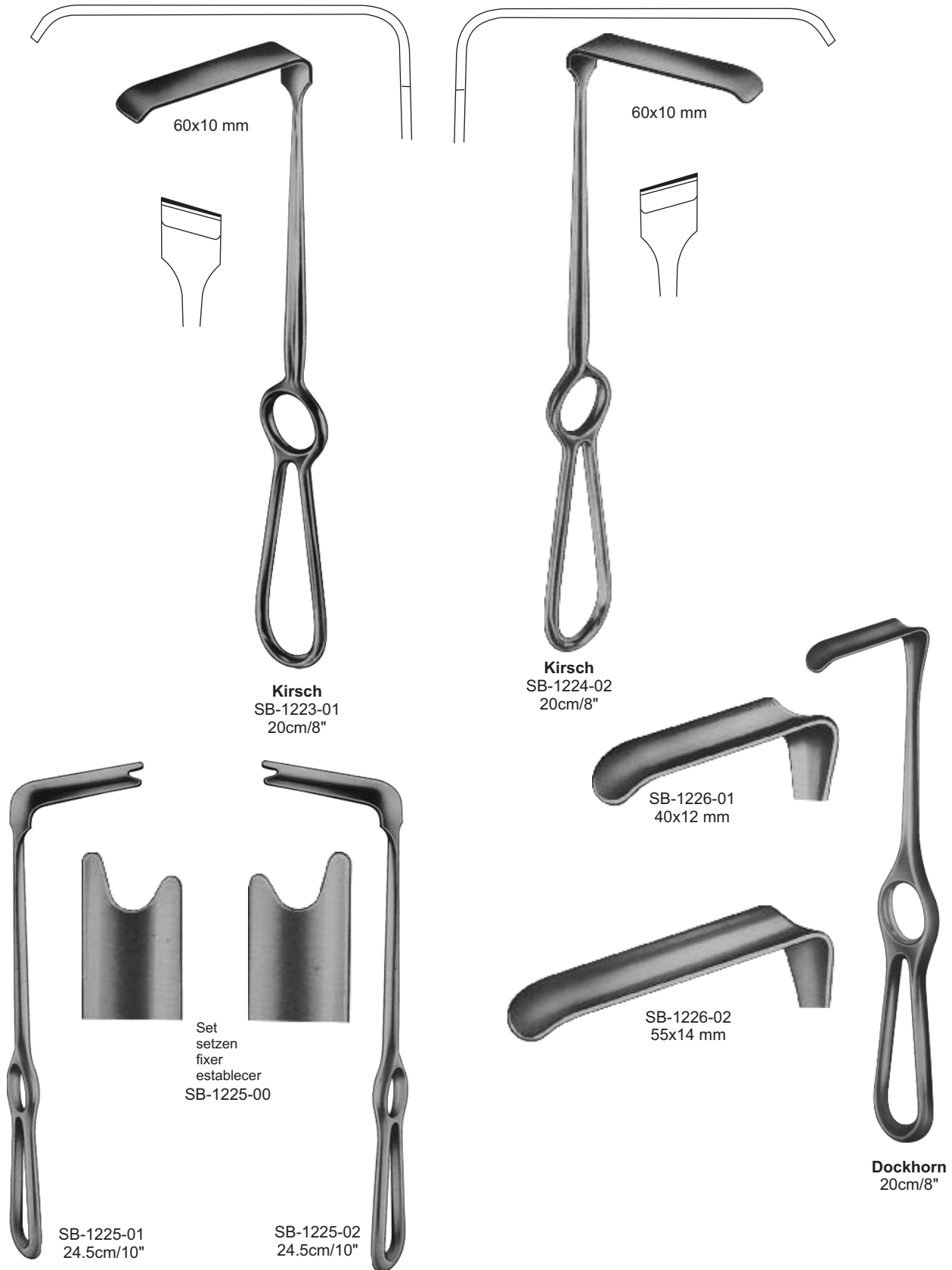

General Instruments

Retractors for Maxillofacial Surgery
Retraktoren für Kiefer-und Gesichtschirurgie

Rétracteurs pour la chirurgie maxillo-faciale
Los retractoros para cirugía maxilofacial

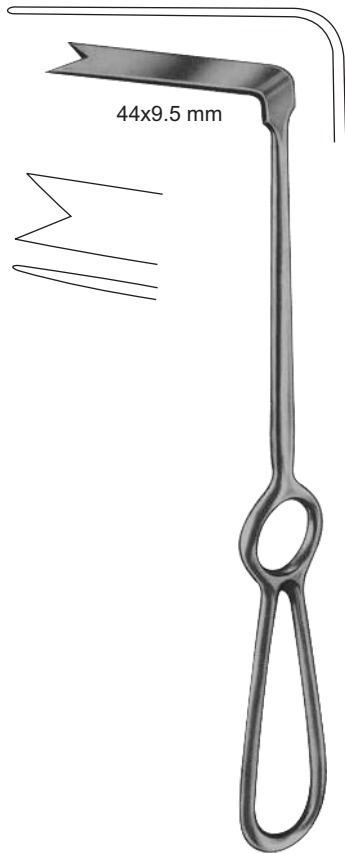

Spina-Nalis
SB-1227-01
22 cm/8¾"

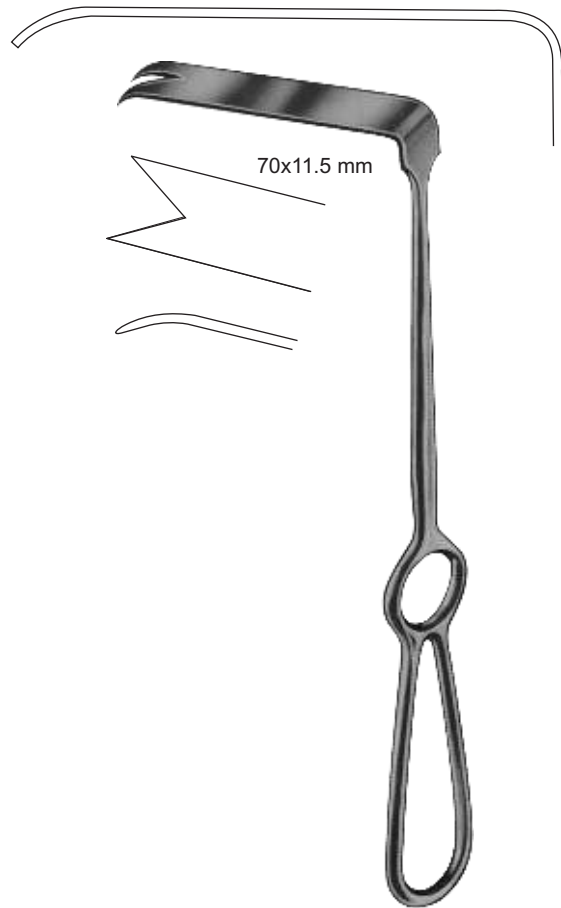

Ramus
SB-1228-02
22 cm/8¾"



Obwegeser
SB-1229-15
15.5 cm/6"



Obwegeser
SB-1230-16
16 cm/6¼"

General Instruments

Retractors for Maxillofacial Surgery
Retraktoren für Kiefer-und Gesichtschirurgie

Rétracteurs pour la chirurgie maxillo-faciale
Los retractores para cirugía maxilofacial

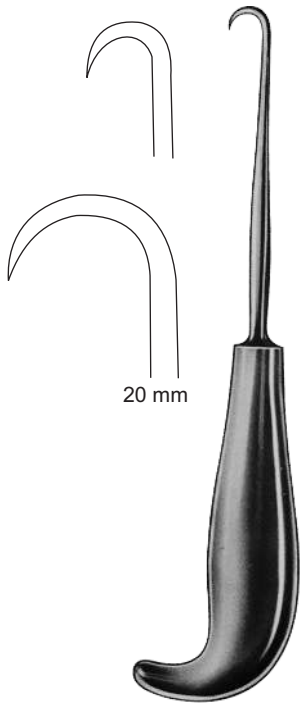

SB-1231-10 10 mm
SB-1231-20 20 mm
19cm/7½"



Dingman
SB-1232-17
17.5cm/7"



Soeresen-Hein
SB-1233-17
17.5cm/7"



Dingman
SB-1234-21
21cm/8¼"



SB-1235-18
18.5cm/7 "

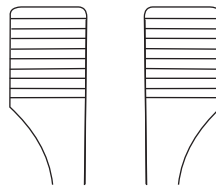

Tessier
SB-1236-01
15cm/6"



Tessier
SB-1236-02
15cm/6"



Dingman
SB-1237-00

General Instruments

Retractors for Maxillofacial Surgery
Retraktoren für Kiefer-und Gesichtschirurgie

Rétracteurs pour la chirurgie maxillo-faciale
Los retractoros para cirugía maxilofacial



Obwegeser-Freer
SB-1238-21
21cm/8 1/4"



Obwegeser-Freer
SB-1239-20
20.5cm/8"

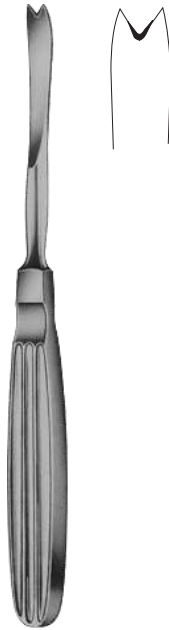

Obwegeser
SB-1240-17
17.5cm/7"



SB-1241-05
5 mm



SB-1241-08
8 mm



SB-1241-09
9 mm

Obwegeser
20cm/8"



Obwegeser
SB-1244-23
23.5cm/9 1/4"
10 mm



Obwegeser
17.5cm/7"



SB-1242-06
6 mm



SB-1242-07
7 mm



SB-1242-11
11 mm



SB-1242-11
11 mm



Dingman
SB-1243-18
18cm/7"

General Instruments

Osteotome for Maxillofacial Surgery
Osteotome für Kiefer-und Gesichtschirurgie

Ostéotome pour Chirurgie Maxillo-Faciale
Osteotomo de Cirugía Maxilofacial



Tessier
20.5cm/8"

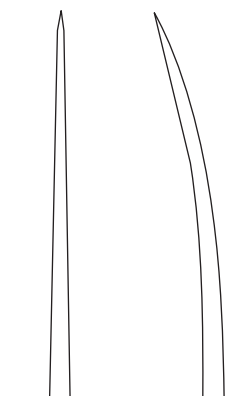

SB-1245-10
10 mm

SB-1246-10
10 mm



Obwegeser
SB-1247-01
18.5cm/7 1/4"



Obwegeser
SB-1248-02
18.5cm/7 1/4"



SB-1249-07
7 mm
21.5cm/8 1/2"



SB-1250-10
10 mm
21.5cm/8 1/2"



SB-1251-02
2.5 mm



15cm/6"



SB-1251-04
4 mm



Bowdler-Henry's
SB-1252-16
16.5cm/6 1/2"



Gillies
SB-1253-21
21cm/8 1/4"



Gillies
SB-1254-21
21cm/8 1/4"

General Instruments

Awls for Maxillofacial Surgery
Ahlen für Kiefer-und Gesichtschirurgie

Alènes pour Chirurgie Maxillo-Faciale
Punzones de Cirugia Oral y Maxilofacial



Sanders-Brown
SB-1255-30
30cm/12"



Sanders-Brown
SB-1256-29
29cm/11½"



Obwegeser
SB-1257-14
14cm/5½"



Obwegeser
SB-1258-23
23cm/9"



Obwegeser
SB-1259-18
18cm/7"



Kelsey-Fry
SB-1260-16
15cm/6"



Kelsey-Fry
SB-1260-18
18cm/7"



Mershon
SB-1261-14
14.5cm/5½"

Band Pusher
Pusher Band

General Instruments

Retractors
Retraktoren

Rétracteurs
Retradores



Bose



Finsen



Finsen

Sharp
scharf
net
agudo

| cm | in | | | | | |
|----|---------------------------------|------------|------------|--|------------|------------------|
| 5 | 2 | | SB-1263-05 | | SB-1264-05 | SB-1265-05 |
| 7 | 2 ³ / ₄ " | SB-1262-07 | SB-1263-07 | | SB-1264-07 | SB-1265-07 Blunt |

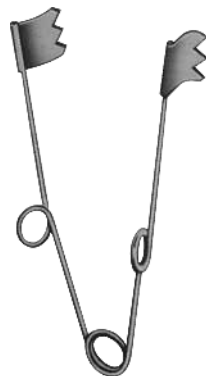

Allport
SB-1267-09
9.5cm/3³/₄"

Sharp
scharf
net
agudo



Alm

blunt
stumpf
émousser
embotar

| cm | in | | cm | in | | |
|------|---------------------------------|------------|----|---------------------------------|------------|------------|
| 8.5 | 3 ¹ / ₂ " | SB-1266-08 | 7 | 2 ³ / ₄ " | SB-1268-07 | SB-1269-07 |
| 11.5 | 4 ¹ / ₂ " | SB-1266-11 | 10 | 4 | SB-1268-10 | SB-1269-10 |

General Instruments

Retractors
Retraktoren

Rétracteurs
Retractoros



Sharp
scharf
net
agudo

Holzheimer

blunt
stumpf
émousser
embotar

SB-1270-10 10 cm/4" SB-1271-10



Sharp
scharf
net
agudo

Jansen

blunt
stumpf
émousser
embotar

SB-1272-10 10.5 cm/4¼" SB-1273-10



Sharp
scharf
net
agudo

Jansen-Deep

blunt
stumpf
émousser
embotar

SB-1274-10 10.5 cm/4¼" SB-1275-10



Belucci

SB-1276-11 11.5cm/4½"
SB-1276-13 13cm/5"



Belucci

SB-1277-11
SB-1277-13



Sharp
scharf
net
agudo

Plester

blunt
stumpf
émousser
embotar

SB-1278-13 13 cm/5" SB-1279-13

General Instruments

Retractors
Retraktoren

Rétracteurs
Retradores



Sharp
scharf
net
agudo

Weitlaner

blunt
stumpf
émousser
embotar

SB-1281-10



Sharp
scharf
net
agudo

Weitlaner

blunt
stumpf
émousser
embotar

SB-1282-13

SB-1282-16

SB-1283-13

SB-1283-16



Weitlaner-Wullstein

Sharp
scharf
net
agudo

blunt
stumpf
émousser
embotar

SB-1284-13

SB-1284-16

SB-1285-13

SB-1285-16

10.5 cm/4¼"

SB-1280-10

13 cm/5"

16.5 cm/6½"



Mollison
SB-1286-15
15 cm/6"

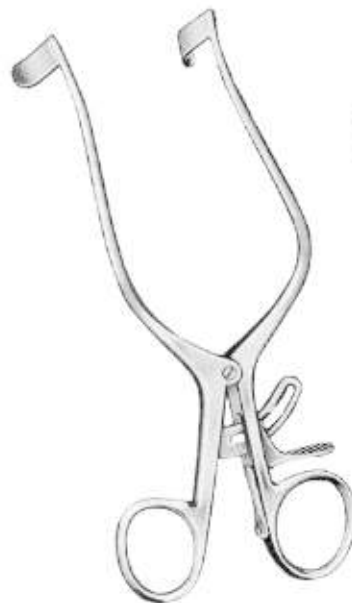

Tuebinger-Modell
SB-1287-16
16 cm/6¼"

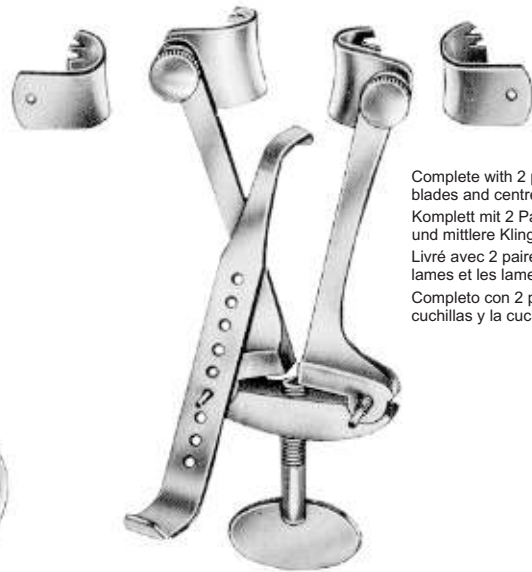

Henner(Lempert)
SB-1288-12
12 cm/4½"

Complete with 2 pairs of blades and centre blade
Komplett mit 2 Paar Klängen und mittlere Klängen
Livré avec 2 paires de les lames et les lames centre
Completo con 2 pares de cuchillas y la cuchilla centro

General Instruments

Retractors
Retraktoren

Rétracteurs
Retractoros

Complete with 3 Central blades
Komplett mit 3 Central Klängen
Livré avec 3 lames centrales
Completo con 3 cuchillas centrales



Sharp
scharf
net
agudo

Henley

blunt
stumpf
émousser
embotar

SB-1289-16 16.5 cm/6½" SB-1290-16

Central blades, only
Zentral Klängen, nur
Lames centrales, ne
Hojas centrales, sólo



SB-1291-19
16x19 mm

SB-1291-25
16x25 mm

SB-1291-32
16x32 mm

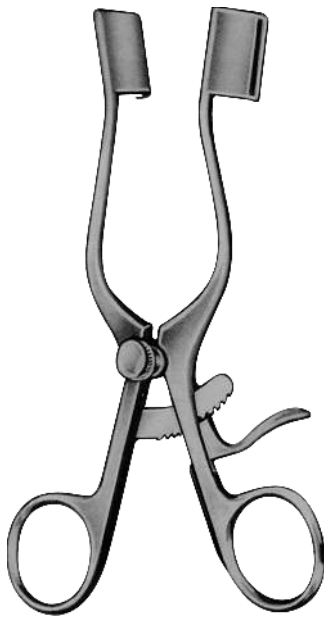

Weitlaner-Baby

13 cm/5"
16 cm/6¼" SB-1292-13



Sharp
scharf
net
agudo

Milligan

blunt
stumpf
émousser
embotar

SB-1293-13 SB-1294-13



Sharp
scharf
net
agudo

Cone (Adson-Baby)

blunt
stumpf
émousser
embotar

SB-1295-13 SB-1296-13
SB-1295-16 SB-1296-16

General Instruments

Retractors
Retraktoren

Rétracteurs
Retradores



Weitlaner

20 cm/8"
25 cm/10"



3x4 Teeth

Sharp
scharf
net
agudo

SB-1297-20
SB-1297-25

blunt
stumpf
émousser
embotar

SB-1298-20
SB-1298-25

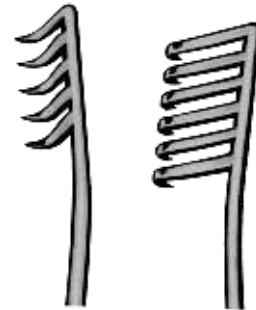

5x6 Teeth

Sharp
scharf
net
agudo

SB-1299-25

blunt
stumpf
émousser
embotar

SB-1300-25



Adson

Sharp
scharf
net
agudo

20 cm/8" SB-1301-20
26 cm/10¼" SB-1301-26

blunt
stumpf
émousser
embotar

SB-1302-20
SB-1302-26



Anderson-Adson

Sharp
scharf
net
agudo

SB-1303-20

blunt
stumpf
émousser
embotar

SB-1304-20



Cone

Sharp
scharf
net
agudo

SB-1305-20
SB-1305-26

blunt
stumpf
émousser
embotar

SB-1306-20
SB-1306-26

General Instruments

Retractors
Retraktoren

Rétracteurs
Retractoros



Travers
06-1307-21
21 cm/8¼"

Jaws Depth

25 mm
44 mm

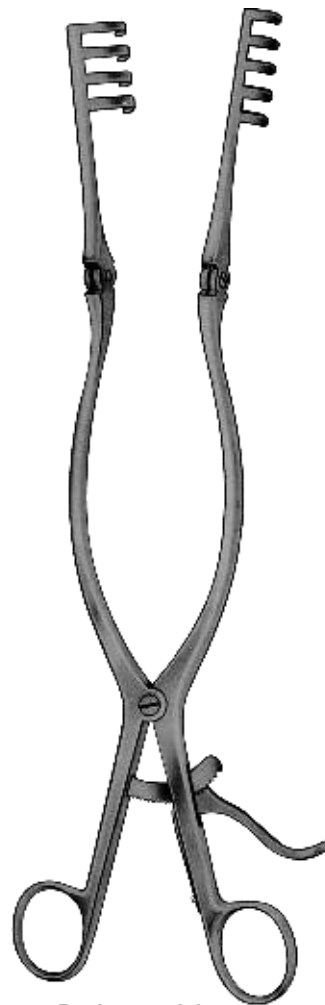

Beckmann-Adson

31 cm/12¼"

Sharp
scharf
net
agudo

blunt
stumpf
émousser
embotar

SB-1308-01
SB-1308-02

SB-1309-01
SB-1309-02



Adson

27 cm/10½"

Sharp
scharf
net
agudo

blunt
stumpf
émousser
embotar

SB-1310-27

SB-1311-27

General Instruments

Retractors
Retraktoren

Rétracteurs
Retradores

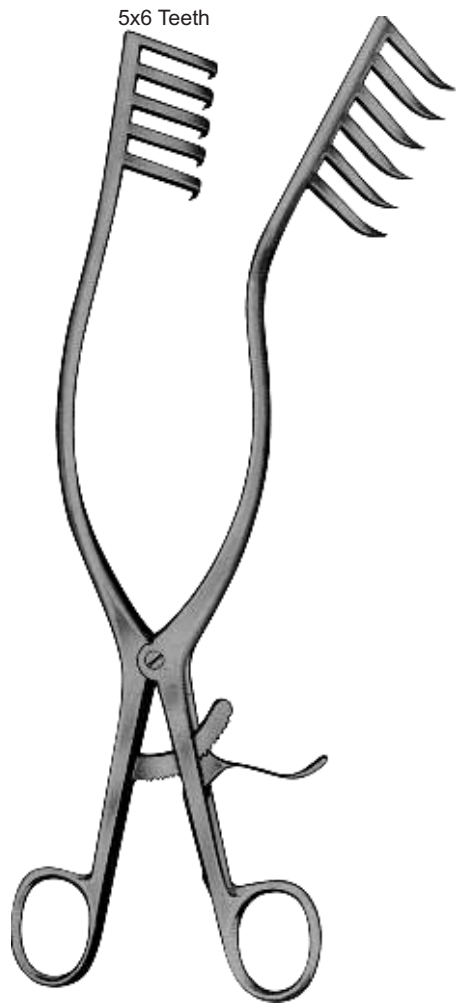

Adson

SB-1312-27 27cm/10½" SB-1313-27



Beckmann

SB-1314-01 10mm 14cm/5½"
SB-1314-02 12mm 17cm/6¾"
SB-1314-03 15mm 21cm/8¼"
SB-1314-04 20mm
SB-1314-05 30 mm
SB-1314-06 50mm
30 cm/12"



Sharp scharf net agudo **BeckMann** blunt stumpf émousser embotar

SB-1315-31 31cm/12¼" SB-1315-31

General Instruments

Abdominal Retractors
Bauchdeckenhalter

Rétracteurs abdominale
Los retractoros abdominales

Hemilaminectomy Retractor
Hemilaminectomie Retraktor
enrouleur hémilaminectomie
hemilaminectomia retractor



SB-1316-27
27cm/10½"



Beckmann-Eaton
SB-1317-33
33 cm/13"

Retractors Only
Wundhaken Nur
Sólo Retractores...
Seulement Rétracteurs

SB-1318-01

Lateral Blades
seitlichen Flügel
lames latérales
cuchillas laterales

SB-1318-02

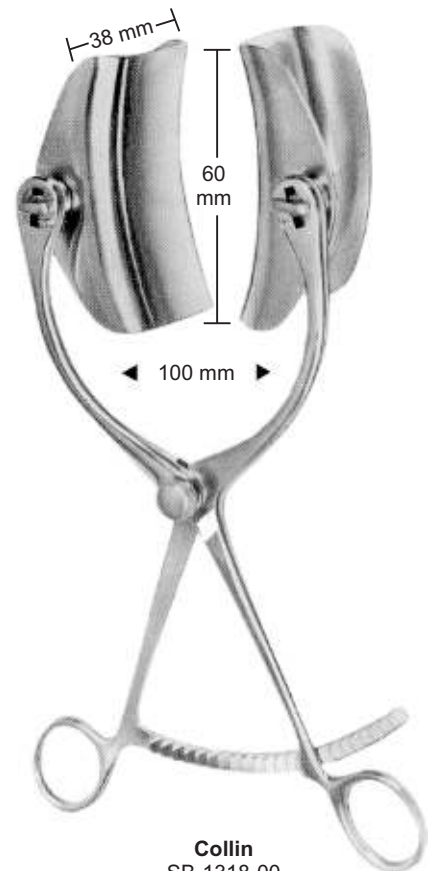

Collin
SB-1318-00
22cm/8¾"

General Instruments

Abdominal Retractors
Bauchdeckenhalter

Rétracteurs abdominale
Los retractoros abdominales



Collin
22 cm/8¾"

Retractors Complete
Wundhaken Vollständige
Ecarteurs complètes
Retractoros completos

Retractors Only
Wundhaken Nur
Sólo Retractoros...
Seulement Rétracteurs

Lateral Blades
seitlichen Flügel
lames latérales
cuchillas laterales

Central Blades
zentralen Klingen
lames centrales
paletas centrales

Fig. 1
SB-1319-00

Fig. 2
SB-1320-00

Fig. 3
SB-1321-00

SB-1319-01

SB-1320-01

SB-1321-01

SB-1319-02
38x60 mm

SB-1320-02
38x80 mm

SB-1321-02
38x100 mm

SB-1319-03
55x55 mm

SB-1321-03
55x75 mm

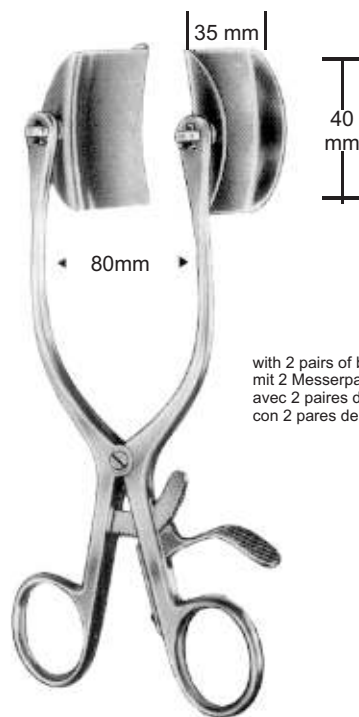

Baby-Collin
SB-1322-00
18 cm/7"

with 2 pairs of blades
mit 2 Messerpaaren
avec 2 paires de lames
con 2 pares de cuchillas



SB-1322-01

General Instruments

Abdominal Retractors
Bauchdeckenhalter

Rétracteurs abdominale
Los retractoros abdominales

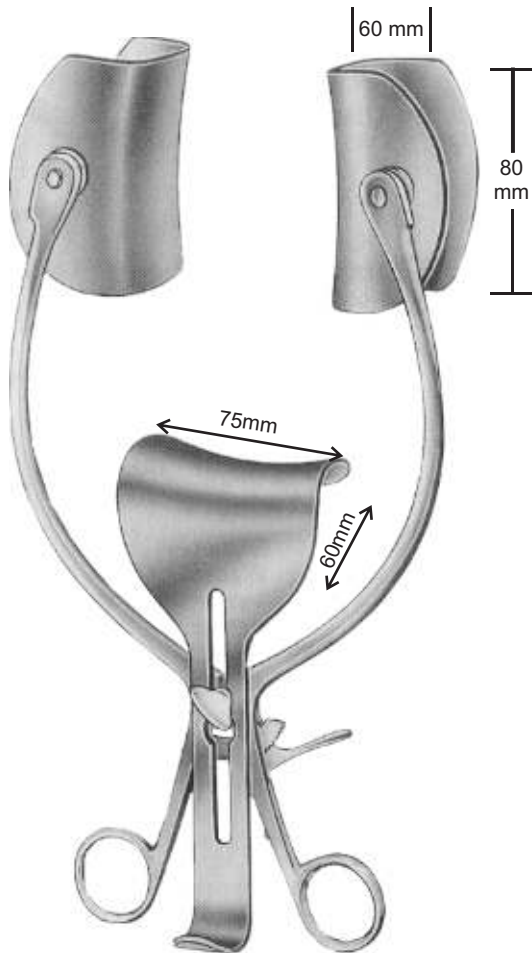

Collin

26 cm/10 1/2"

Retractors Complete
Wundhaken Vollständige
Ecarteurs complètes
Retractoros completos

SB-1323-00
26cm/10 1/2"

Lateral Blades
seitlichen Flügel
lames latérales
cuchillas laterales

SB-1323-01
60X80mm

Central Blades
zentralen Klängen
lames centrales
paletas centrales

SB-1323-02
75X60mm

Retractors Only
Wundhaken Nur
Sólo Retractoros...
Seulement Rétracteurs

SB-1323-03



Mayo-Adams
SB-1324-17
17cm/6 3/4"



Mayo-Adams
SB-1325-17
17cm/6 3/4"

General Instruments

Abdominal and Vulval Retractors
Bauch-und Vulva Retraktoren

Rétracteurs abdominaux et de la vulve
Los retractoros abdominales y la vulva

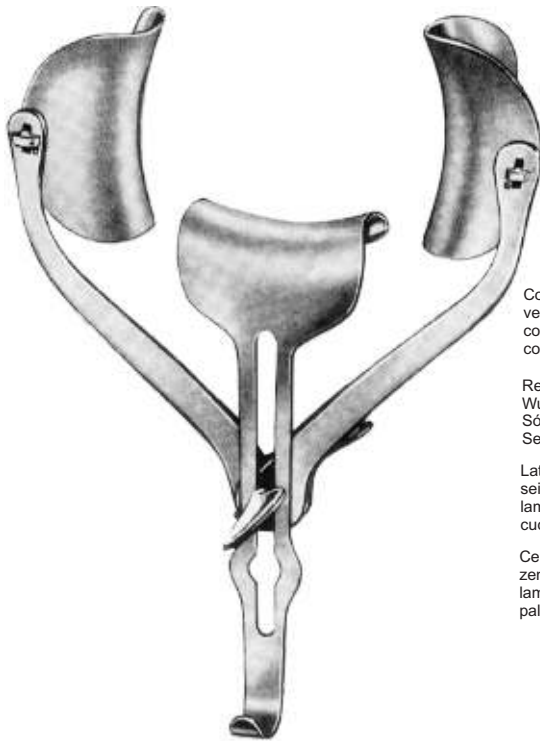

Ricard
SB-1326-28 28cm/11"
SB-1326-30 30cm/12"

Complete
vervollständigen
completér
completar

Fig. 1
SB-1326-00

Fig. 2
SB-1327-00

Retractors Only
Wundhaken Nur
Sólo Retractores...
Seulement Rétracteurs

SB-1326-01

SB-1327-01

Lateral Blades
seitlichen Flügel
lames latérales
cuchillas laterales

SB-1326-02
60x80 mm

SB-1327-02
75x85 mm

Central Blades
zentralen Klingen
lames centrales
paletas centrales

SB-1326-03
55x70 mm

SB-1327-03
80x90 mm



Vulval Retractor
Vulva Retractor
Écarteur vulvaire
Retractor vulvar

Richter
SB-1328-16
16.5 cm/6 1/2"



Gelpi
SB-1330-09 9 cm/3 1/2"
SB-1330-11 11 cm/4 1/2"
SB-1330-13 13 cm/5"
SB-1330-18 18 cm/7"



Gelpi
SB-1331-18
18 cm/7"

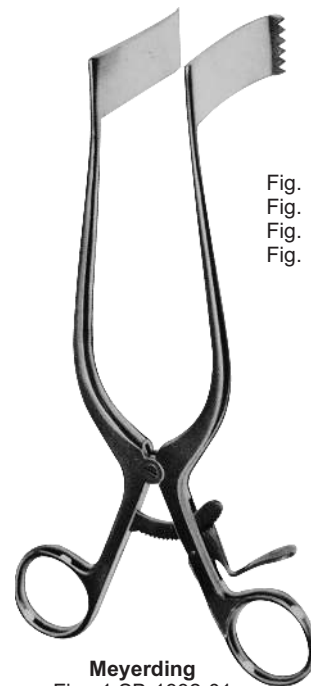

Meyerding
Fig. 1 SB-1332-01
Fig. 2 SB-1332-02
Fig. 3 SB-1332-03
Fig. 4 SB-1332-04
18 cm/7"

blades
Klingen
Lames
Hojas

Fig. 1 1 3/4"x1"
Fig. 2 2 1/8"x1"
Fig. 3 2 3/8"x1 3/4"
Fig. 4 2 3/8"x1"

General Instruments

Abdominal Retractors
Bauchdeckenhalter

Rétracteurs abdominale
Los retractoros abdominales



Markham-Meyering

SB-1333-18 18cm/7" SB-1334-18

Rigby

SB-1335-19
19cm/7½"

De Bakey

SB-1336-12 12cm/4¾"
SB-1336-17 17cm/6¾"

10cm/4"

40x30mm

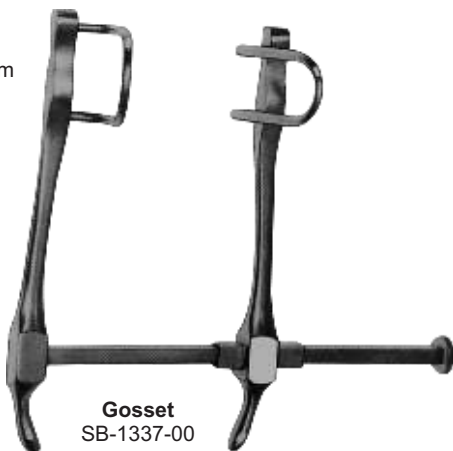

Gosset
SB-1337-00

140mm

63x35mm



Gosset
SB-1338-00

General Instruments

Abdominal Retractors
Bauchdeckenhalter

Rétracteurs abdominale
Los retractoros abdominales

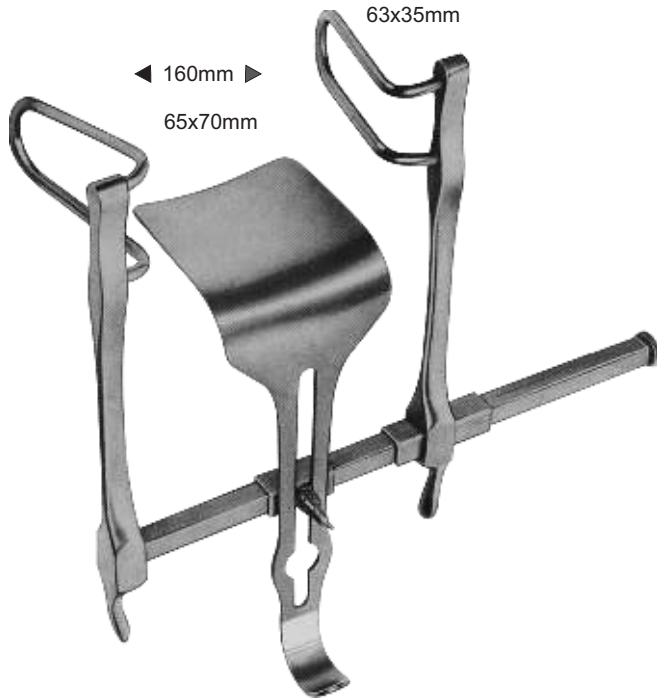

Gosset
SB-1339-16

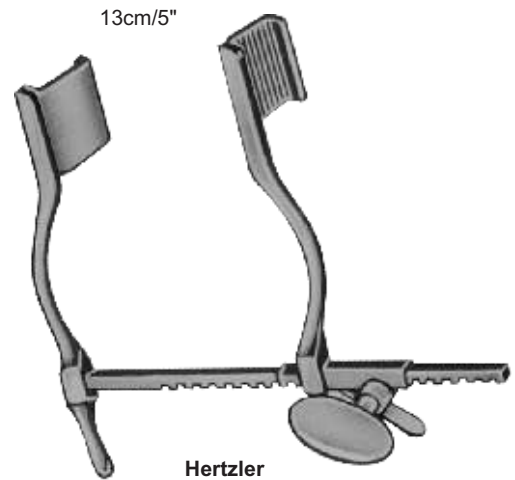

Hertzler
SB-1340-00

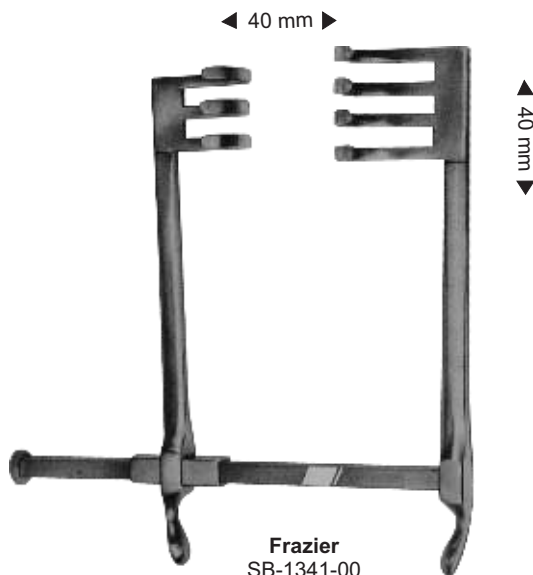

Frazier
SB-1341-00

General Instruments

Retractors
Retraktoren

Rétracteurs
Retradores

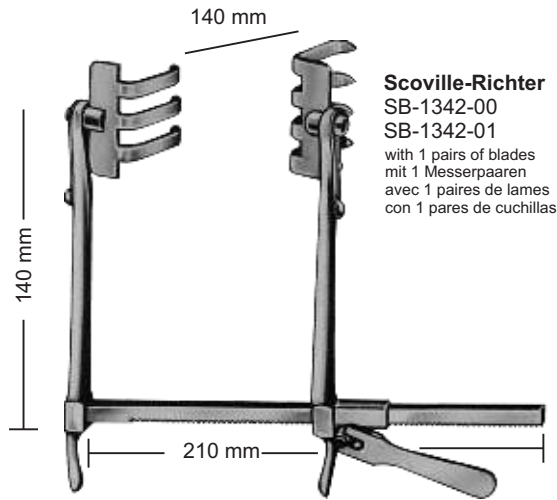

Scoville-Richter
SB-1342-00
SB-1342-01
with 1 pairs of blades
mit 1 Messerpaaren
avec 1 paires de lames
con 1 pares de cuchillas

the blades are available by pairs
die Schaufeln sind durch Paare
les lames sont disponibles par paires
Las cuchillas están disponibles por pares



SB-1343-01
60x50 mm

SB-1343-02
48x50 mm



SB-1343-03
28x40 mm



SB-1343-04
38x62 mm

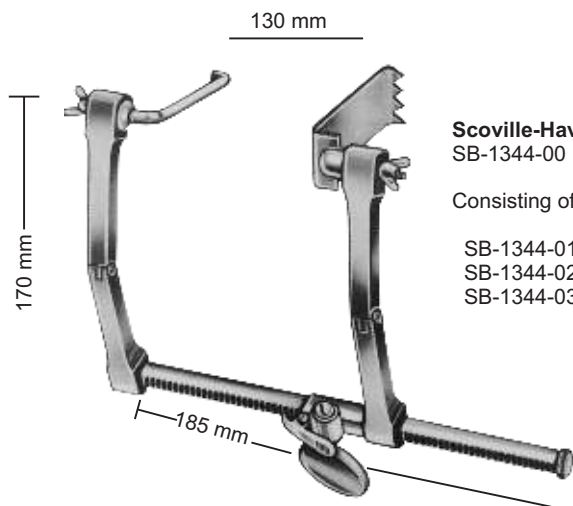

Scoville-Haverfield
SB-1344-00

Consisting of:

- SB-1344-01
- SB-1344-02
- SB-1344-03



Scoville
SB-1345-02
51 mm



Scoville
SB-1345-03 63x25 mm
SB-1345-04 63x51 mm
SB-1345-05 67x32 mm
SB-1345-06 89x25 mm



Taylor
SB-1345-07
48x38 mm



Taylor
SB-1345-08 63x51 mm
SB-1345-09 79x57 mm

General Instruments

Abdominal Retractors Rétracteurs abdominale
Bauchdeckenhalter Los retractoros abdominales

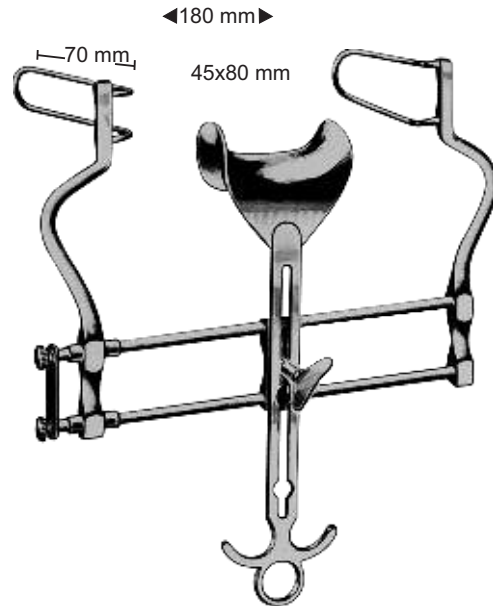
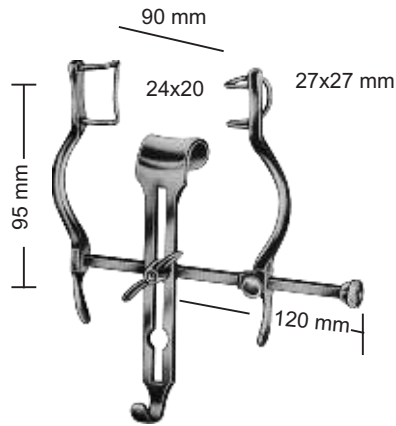

Retractors Complete
Wundhaken Vollständige
Ecarteurs complètes
Retradores completos

Baby-Balfour
SB-1346-00

Balfour
SB-1347-18

Retractors Only
Wundhaken Nur
Sólo Retradores...
Seulement Rétracteurs

SB-1346-01

SB-1347-01

Central Blades
zentralen Klängen
lames centrales
paletas centrales

SB-1346-02
24x20mm

SB-1347-02
45x80mm

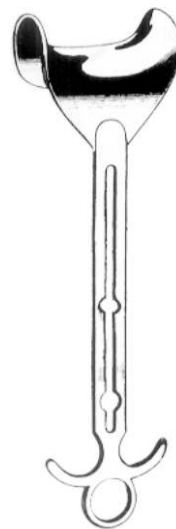

Balfour
SB-1348-01 80x90mm

General Instruments

Abdominal Retractors
Bauchdeckenhalter

Rétracteurs abdominale
Los retractoros abdominales

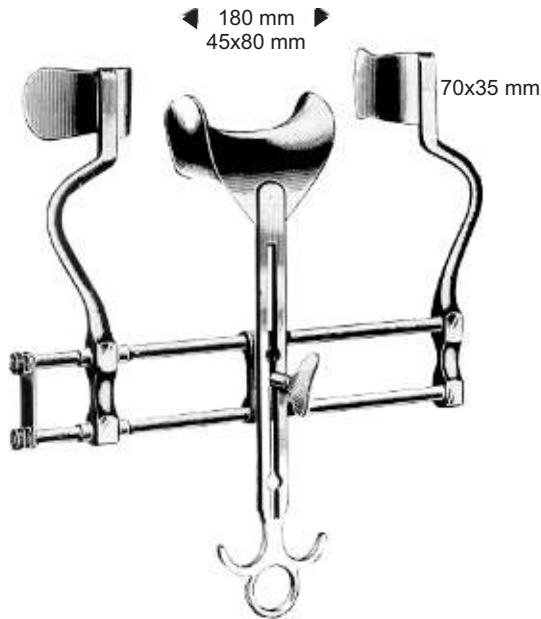

Balfour

Retractors Complete
Wundhaken Vollständige
Ecarteurs complètes
Retractoros completos
SB-1349-18

Retractors Only
Wundhaken Nur
Sólo Retractoros...
Seulement Rétracteurs
SB-1349-01

Central Blades
zentralen Klängen
lames centrales
paletas centrales
SB-1349-02
45x80mm

Solid blade

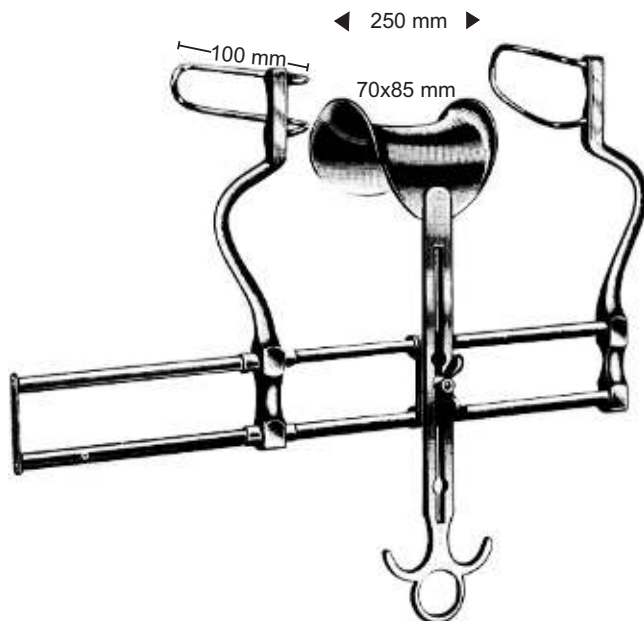

Balfour
SB-1350-25

Retractors Complete
Wundhaken Vollständige
Ecarteurs complètes
Retractoros completos
SB-1350-25

Retractors Only
Wundhaken Nur
Sólo Retractoros...
Seulement Rétracteurs
SB-1350-01

Central Blades
zentralen Klängen
lames centrales
paletas centrales
SB-1350-02
70x85mm

General Instruments

Abdominal Retractors
Bauchdeckenhalter

Rétracteurs abdominale
Los retractoros abdominales

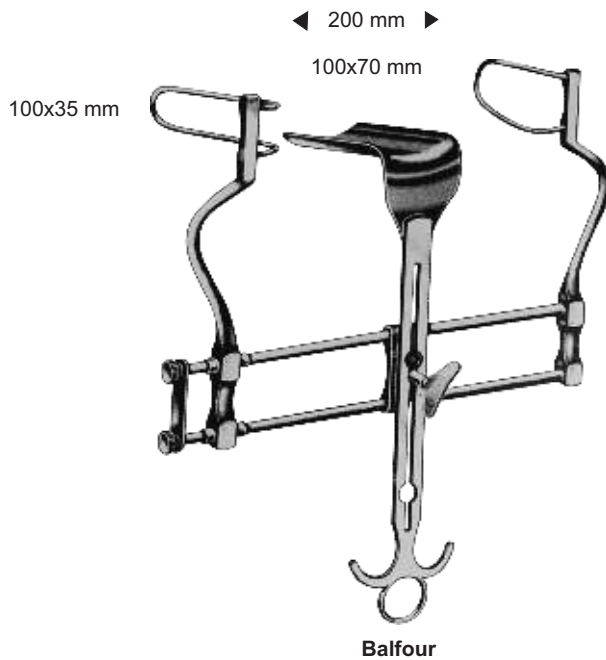

Retractors Complete
Wundhaken Vollständige
Ecarteurs complètes
Retractoros completos

SB-1351-20

Retractors Only
Wundhaken Nur
Sólo Retractoros...
Seulement Rétracteurs

SB-1351-01

Central Blades
zentralen Klingen
lames centrales
paletas centrales

SB-1351-02
100x70mm

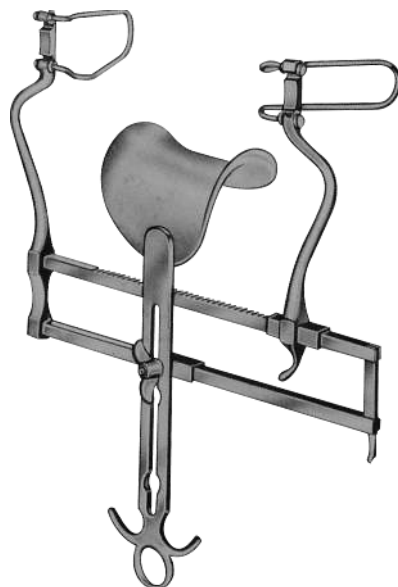

SB-1352-00
Complete



SB-1353-01

Lateral blades, 6cm deep, per pair
seitliche Flügel, 6cm tief, pro Paar
lames latérales, 6cm de profondeur, par paire
cuchillas laterales, 6cm par profunda, por

SB-1353-02

Lateral blades, 8cm deep, per pair
seitliche Flügel, 8cm tief, pro Paar
lames latérales, 8cm de profondeur, par paire
cuchillas laterales, 8cm par profunda, por

Central Blades only
zentralen Klingen Nur
lames centrales Sólo
Seulement paletas centrales

SB-1353-03

40x68mm

SB-1353-04

68x85mm

General Instruments

Abdominal Retractors
Bauchdeckenhalter

Rétracteurs abdominale
Los retractoros abdominales

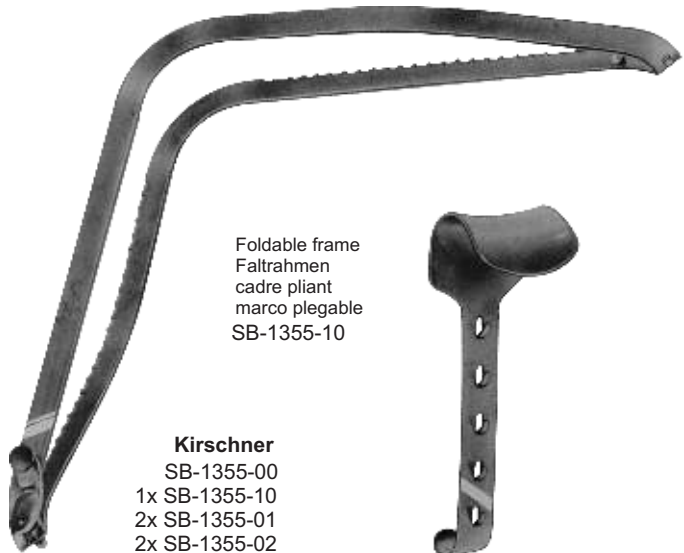
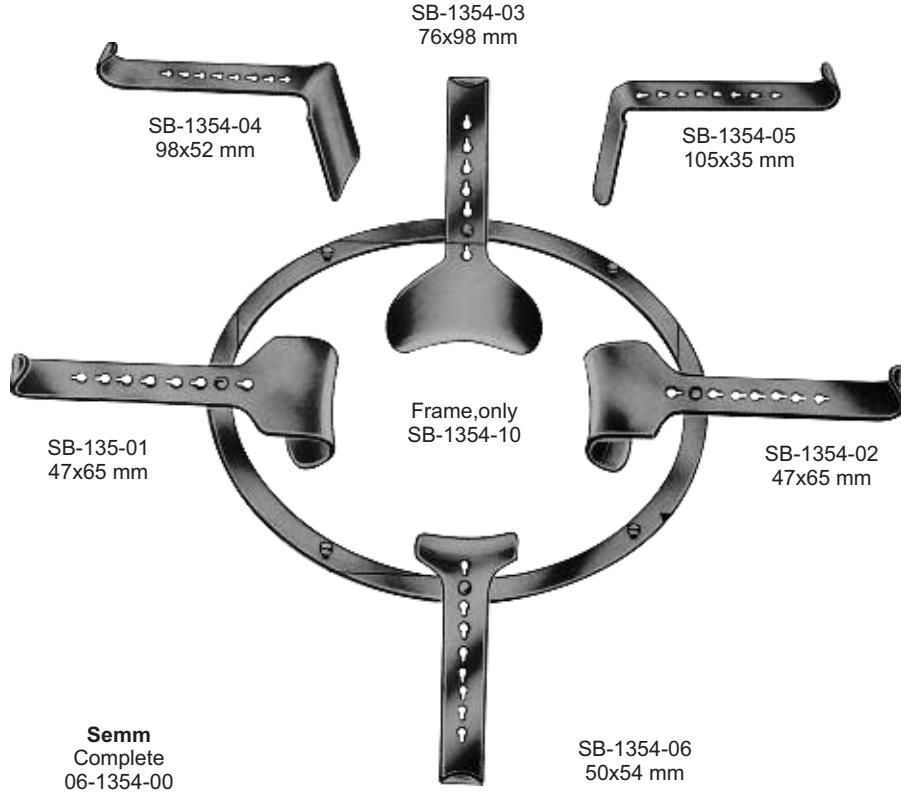

Complete
vervollständigen
compléter
completar

40x55 mm SB-1355-01
50x65 mm SB-1355-02
65x80 mm SB-1355-03
80x80 mm SB-1355-04
90x65 mm SB-1355-05
90x90 mm SB-1355-06



Complete
SB-1356-00
1x SB-1356-10
2x SB-1356-01
2x SB-1356-02

General Instruments

Abdominal Retractors Rétracteurs abdominale
Bauchdeckenhalter Los retractoros abdominales

Frame SB-1357-10 178x140 mm
 SB-1358-20 255x178 mm



Complete
vervollständigen
compléter
completar
SB-1357-00
SB-1358-00

Denis-Brown
Consisting of
bestehend aus
composée d'
Compuesto por

Fig.1 SB-1359-01 38x38 mm
Fig.2 SB-1360-02 38x25 mm



1x SB-1359-10
1x SB-1360-20

2x SB-1359-01
2x SB-1360-01

2x SB-1359-02
2x SB-1360-02

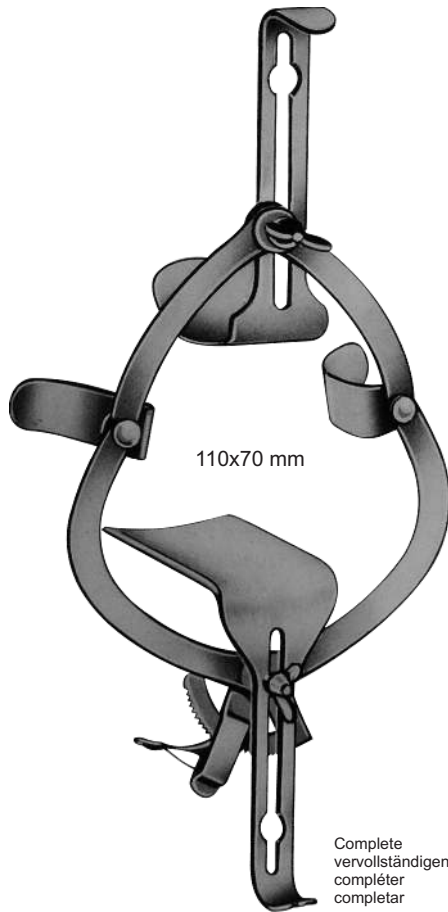

110x70 mm

Complete
vervollständigen
compléter
completar

O'Sullivan-O'Connor
SB-1361-00

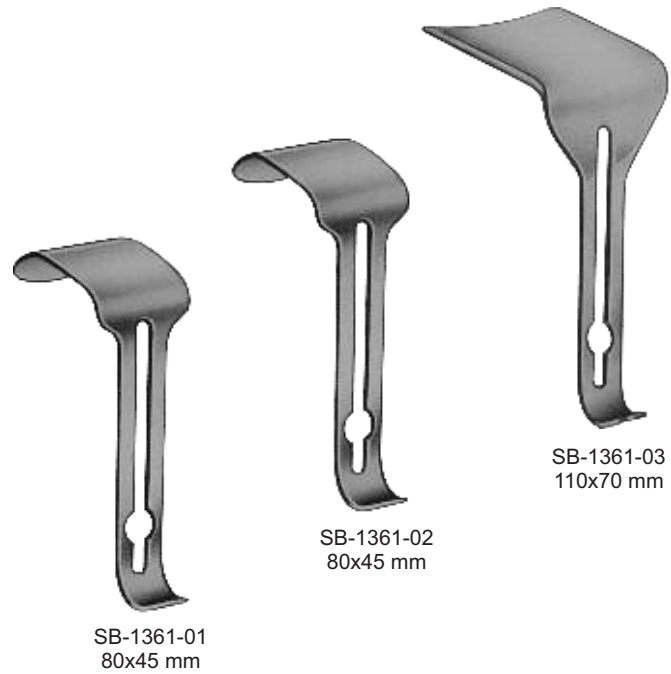

SB-1361-01
80x45 mm

SB-1361-02
80x45 mm

SB-1361-03
110x70 mm

General Instruments

Abdominal Retractors
Bauchdeckenhalter

Rétracteurs abdominale
Los retractoros abdominales



Doyen
SB-1362-01 48x90mm
SB-1362-02 48x105mm
SB-1362-03 48x120mm
SB-1362-04 48x135 mm



Rochard
SB-1363-01 40x80mm
SB-1363-02 50x100mm
SB-1363-03 55x120mm



Doyen-Rochard
SB-1364-01 45x80mm
SB-1364-02 50x100mm
SB-1364-03 65x120mm

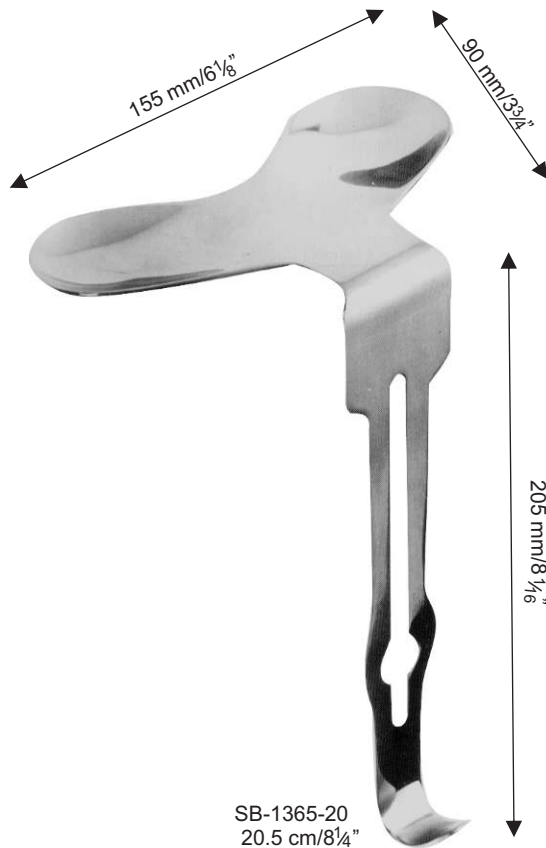

General Instruments

Abdominal Retractors
Bauchdeckenhalter

Rétracteurs abdominale
Los retractoros abdominales



SB-1366-19
19 cm/7½"

SB-1367-10
Foldable frame
Faltrahmen
cadre pliant
marco plegable

SB-1367-01 38x60 mm
SB-1367-02 45x80 mm



Franz

Complete with 4 valves
Komplett mit 4 Ventilen
Fourni avec 4 soupapes
Completa con 4 válvulas
SB-1367-40

Complete with 8 valves
Komplett mit 8 Ventilen
Fourni avec 8 soupapes
Completa con 8 válvulas
SB-1367-80

With
con SB-1367-10 1x
SB-1367-01 2x
SB-1367-03 2x

With
con SB-1367-10 1x
SB-1367-01 2x
SB-1367-02 2x
SB-1367-03 2x
SB-1367-04 2x

06-1367-03 50x65 mm
06-1367-04 60x85 mm

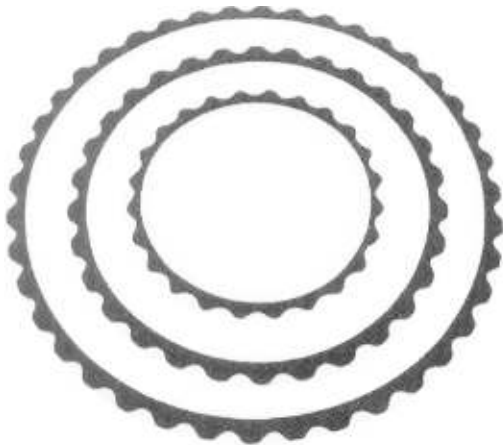

SB-1368-00 Complete Set

Turner Warwick
1x SB-1368-18 18cm/7" Round
1x SB-1368-23 23cm/9" Round
1x SB-1368-30 30cm/12" Round
1x SB-1368-45 45cm/18" Oval
33cm/13"

Copper Blade



2x SB-1368-01
19 x 76 mm

2x SB-1368-02
57 x 89 mm

2x 06-1368-03
38 x 102 mm

2x SB-1368-04
57 x 114 mm



2x SB-1368-05
76 x 60 mm

2x SB-1368-06
51 x 38 mm



2x SB-1368-07
89 x 60 mm

2x SB-1368-08
114 x 60 mm



Serving Health Care

SPEED BIRD

ENTERPRISES



**161/C, SMALL INDUSTRIAL ESTATE
SIALKOT-51310, (PAKISTAN)**



: +92-304 0549944



: +92-52-3555584



: speed@birddent.com



: www.birddent.com