



Serving Health Care

SPEED BIRD
ENTERPRISES

www.birddent.com

GENERAL INSTRUMENTS

SECTION

04

General Instruments

Bulldog Hemostatic Forceps
Bulldog Hämostatische Forceps

Bulldog Forceps hémostatique
Bulldog hemostático Forceps



Dieffenbach
SB-730-03
3.5cm/1½"
SB-730-05
5cm/2"



Dieffenbach
SB-731-03
3.5cm/1½"
SB-731-05
5cm/2"

Straight
gerade
droit
recto

- SB-732-01 38mm/1½"
- SB-732-02 51mm/2"
- SB-732-03 57mm/2¼"
- SB-732-04 63mm/2½"
- SB-732-05 70mm/2¾"
- SB-732-06 75mm/3"
- SB-732-07 90mm/3½"



Curved
Gebogene
courbé
Curvo

- SB-735-01 38mm/1½"
- SB-735-02 51mm/2"
- SB-735-03 57mm/2¼"
- SB-735-04 63mm/2½"
- SB-735-05 70mm/2¾"
- SB-735-06 75mm/3"
- SB-735-07 90mm/3½"



Dieffenbach
SB-733-06
6cm/2½"



Dieffenbach
SB-734-06
6cm/2½"

Johns-Hopkins



SB-736-10
24.5 cm 9 3/4"



Carrel
SB-737-10
10cm/4"

Haemorrhoidal Clamps
Hämorrhoiden Clamps
Pinces hémorroïdaires
Abrazaderas hemorroidales

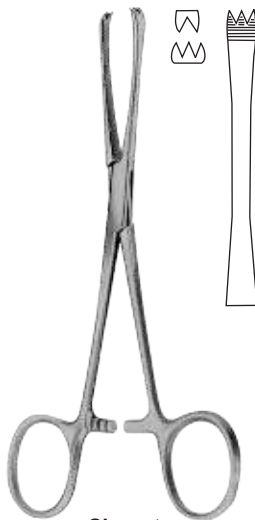

Chaput
SB-738-13
13cm/5"

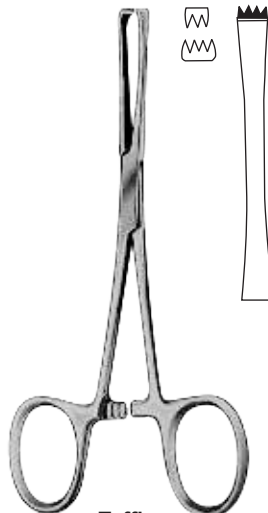

Tuffier
SB-739-13
13cm/5"



Pratt
SB-740-15
15cm/6"

General Instruments

Hemostatic Forceps
Arterienklemmen

pincas h emostatiques
pinzas hemost aticas



Pennington
SB-741-15 15 cm/6"
SB-741-20 20cm/8"



SB-742-00
12.5 cm/5"

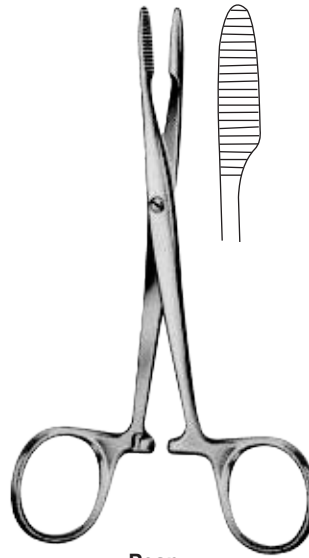

Pean
SB-743-00
16.5cm/6 3/4"

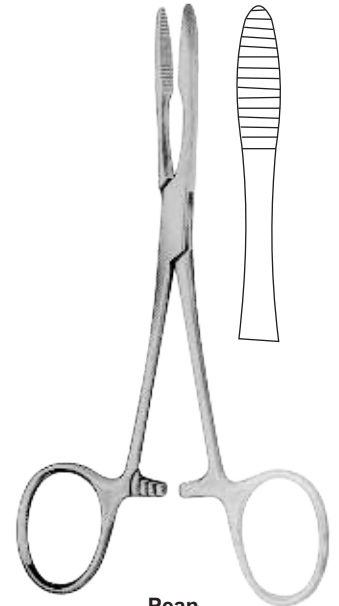

Pean
SB-744-14 14cm/5 1/2"
SB-745-16 16cm/6 1/2"

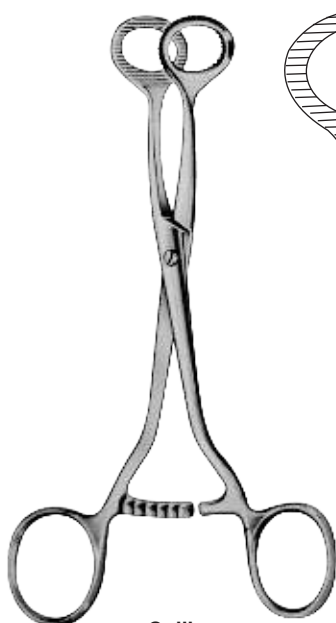

Collin
SB-746-15
15,5 cm/6"

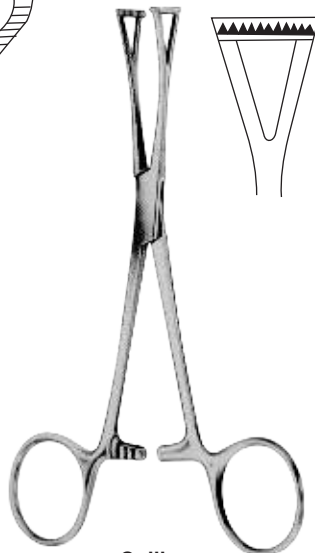

Collin
SB-747-14
14 cm/5 1/2"

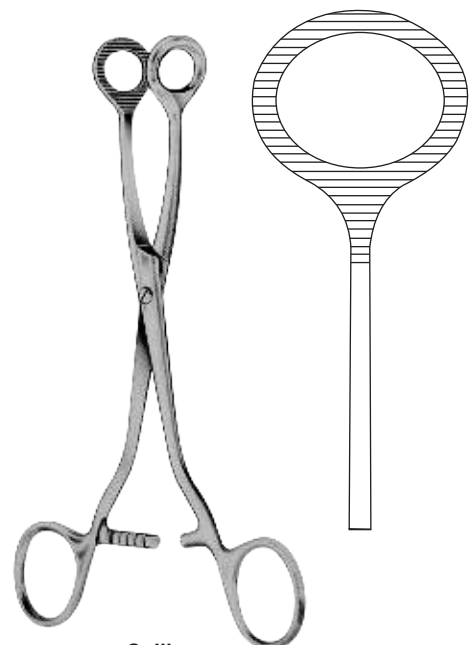

Collin
SB-748-16
16,5 cm/6 1/2"

General Instruments

Hemostatic Forceps
Arterienklemmen

pinces hémostatiques
pinzas hemostáticas



Micro-Mosquito
10 cm/4"
12.5 cm/5 "

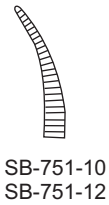
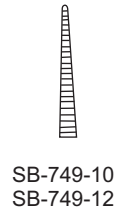

Very fine
sehr feine
très bien
Muy bien

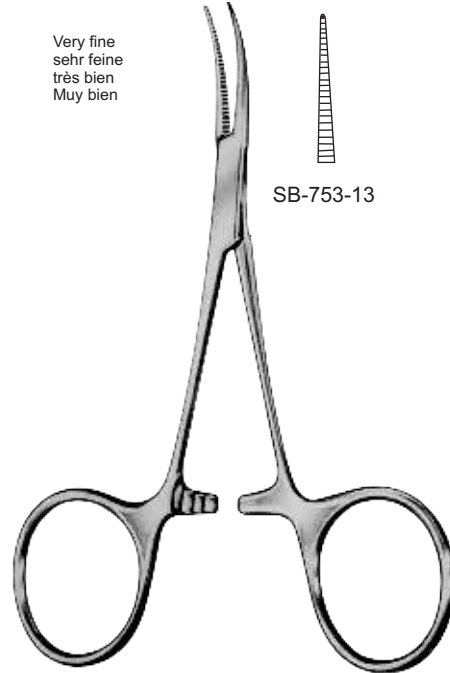
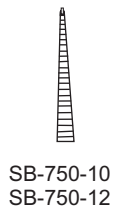
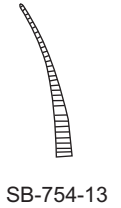
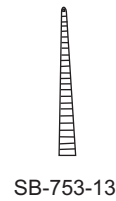

Jacobson-Halstead
12.5 cm/5"



Hartmann
10 cm/4"

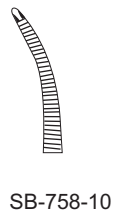
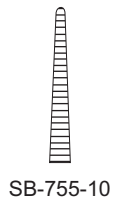

Halstead-Mosquito
12.5 cm/5"
14 cm/5 1/2"

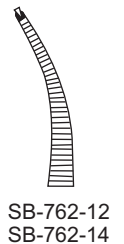
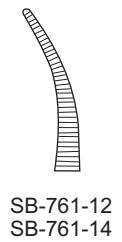
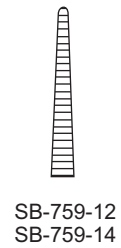

General Instruments

Hemostatic Forceps
Arterienklemmen

pincas hémostatiques
pinzas hemostáticas



Halstead-Mosquito
18 cm/7"
21 cm/8 1/4"



SB-763-18
SB-763-21

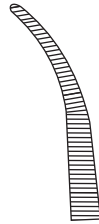

SB-765-18
SB-765-21



SB-764-18
SB-764-21



SB-766-18
SB-766-21

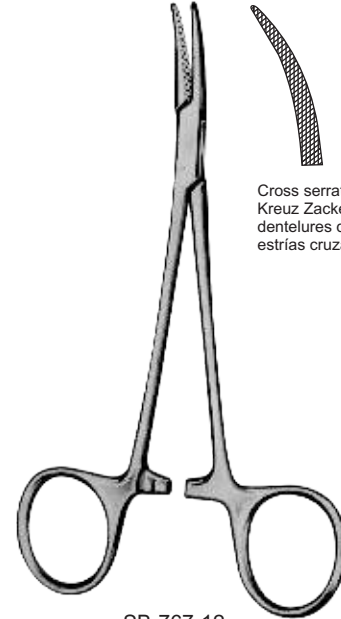

SB-767-12
12 cm / 4 3/4"



Cross serrations
Kreuz Zacken
dentelures de la Croix-
estrias cruzadas



Kally
14 cm/5 1/2"
Kally-Rankin
16 cm/6 1/4"



SB-768-14



14 cm/5 1/2" SB-769-14



SB-768-16



16 cm/6 1/4" SB-769-16

General Instruments

Hemostatic Forceps
Arterienklemmen

pincès hémostatiques
pinzas hemostáticas



Crile
14 cm/5½"

Crile-Rankin
16 cm/6¼"



SB-770-14 14 cm/5½"



SB-772-14



SB-771-16 16 cm/6¼"



SB-773-16

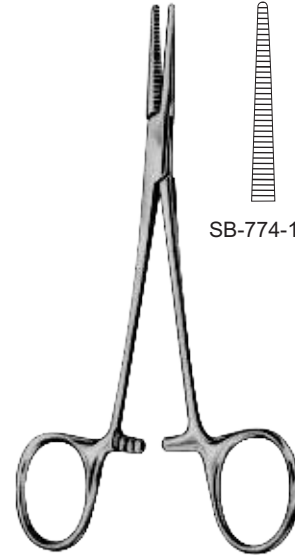

Baby-Crile
14 cm/5½"



SB-774-14



SB-775-14



Crile
14 cm/5½"

Crile-Rankin
16 cm/6¼"



SB-776-14 14 cm/5½"

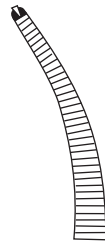

SB-777-14



SB-778-16 16 cm/6¼"

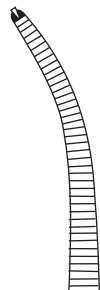

SB-779-16



Baby-Crile
14 cm/5½"



SB-780-14



SB-781-14

General Instruments

Hemostatic Forceps
Arterienklemmen

pinces hémostatiques
pinzas hemostáticas



Collier-Crile

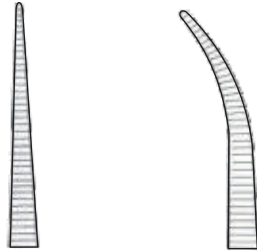

SB-782-14 14 cm/5½" SB-783-14

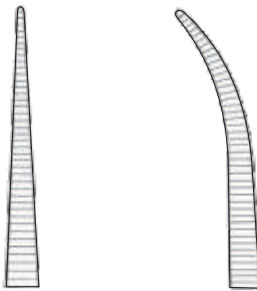

SB-784-16 16 cm/6¼" SB-785-16



Collier-Crile
SB-786-16
16 cm/6¼"



Leriche
15 cm/6"



SB-787-15



SB-788-15



SB-789-15

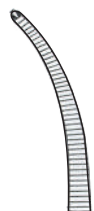

SB-790-15



Providence
14 cm/5½"



SB-791-14



SB-792-14

General Instruments

Hemostatic Forceps
Arterienklemmen

pincès hémostatiques
pinzas hemostáticas

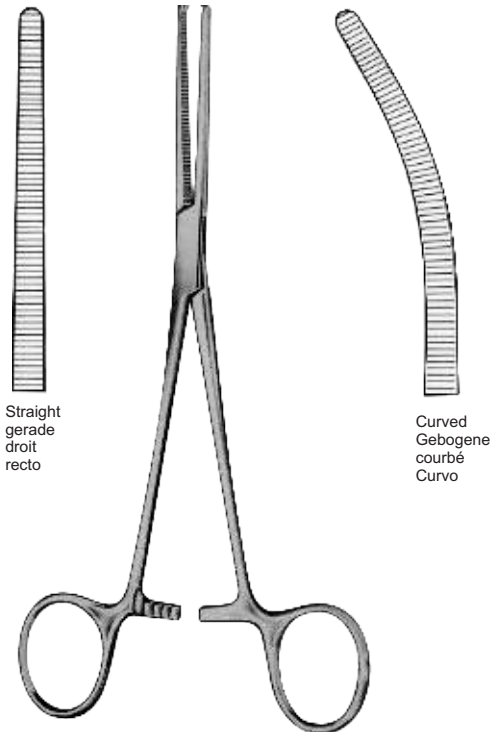

Straight
gerade
droit
recto

Curved
Gebogene
courbé
Curvo

Rochester-Pean

STR	WD	cm	in
SB-793-13	SB-794-13	13.0	5"
SB-793-14	SB-794-14	14.0	5 1/2"
SB-793-16	SB-794-16	16.0	6 1/4"
SB-793-18	SB-794-18	18.0	7"
SB-793-20	SB-794-20	20.0	8"
SB-793-22	SB-794-22	22.0	8 3/4"
SB-793-24	SB-794-24	24.0	9 1/2"
SB-793-26	SB-794-26	26.0	10 1/4"
SB-793-30	SB-794-30	30.0	12"

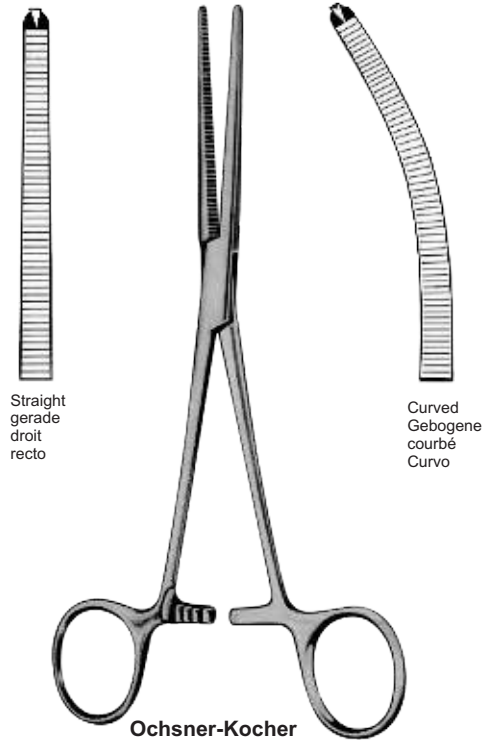

Straight
gerade
droit
recto

Curved
Gebogene
courbé
Curvo

Ochsner-Kocher

STR	WD
SB-795-13	SB-796-13
SB-795-14	SB-796-14
SB-795-16	SB-796-16
SB-795-18	SB-796-18
SB-795-20	SB-796-20
SB-795-22	SB-796-22
SB-795-24	SB-796-24
SB-795-26	SB-796-26
SB-795-30	SB-796-30

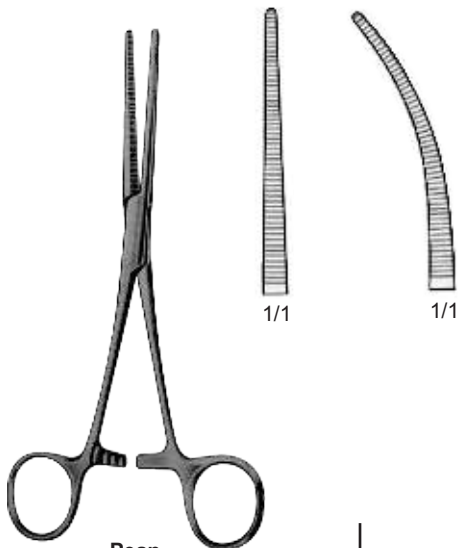

1/1

1/1

Fine
feine
fin
multa

Pean

cm	in
13.0	5"
14.0	5 1/2"
16.0	6 1/4"

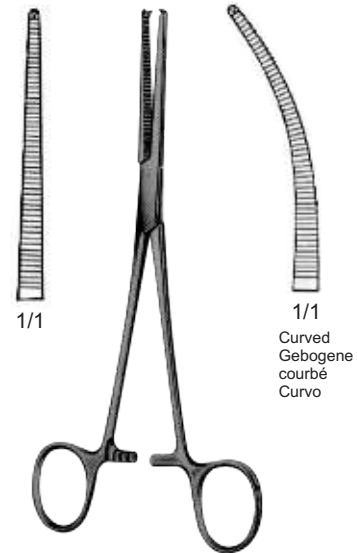

1/1

1/1
Curved
Gebogene
courbé
Curvo

Kocher

SB-799-13	SB-800-13
SB-799-14	SB-800-14
SB-799-16	SB-800-16

General Instruments

Hemostatic Forceps
Arterienklemmen

pincas h emostatiques
pinzas hemost aticas

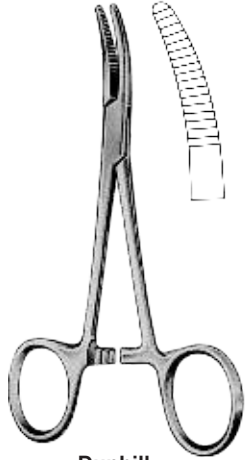

Dunhill
SB-801-13
13cm/5"

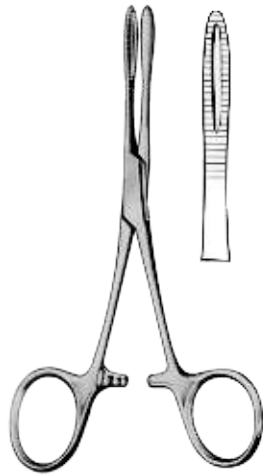

Kronlein
SB-802-13
13cm/5"

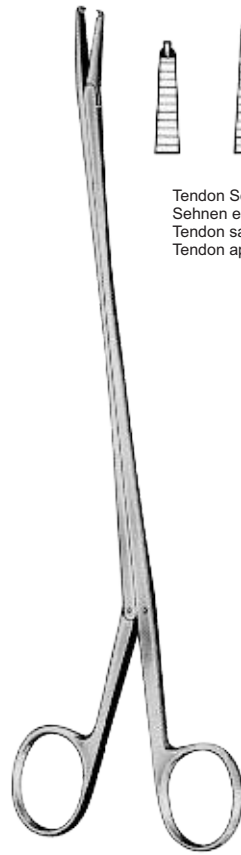

Tendon Seizing Forcep
Sehnen ergriff forcep
Tendon saisir pince
Tendon apoderarse f orceps

Brand
SB-803-15 15cm/6"
SB-803-19 19cm/7 1/2"
SB-803-24 24cm/9 1/2"

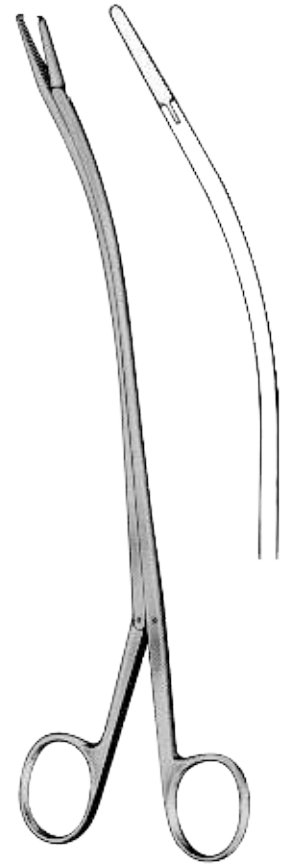

Brand
SB-804-15 15cm/6"
SB-804-19 19cm/7 1/2"
SB-804-24 24cm/9 "

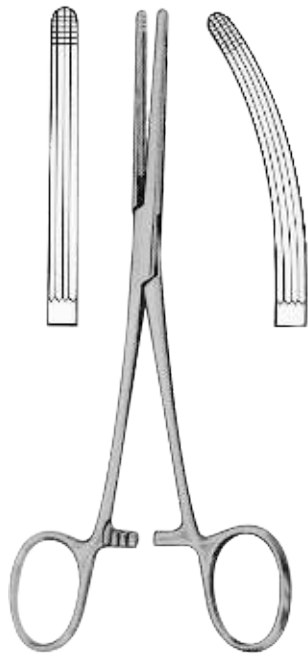

Rochester-Carmalt
SB-805-16
16cm/6 1/4"
20cm/8"

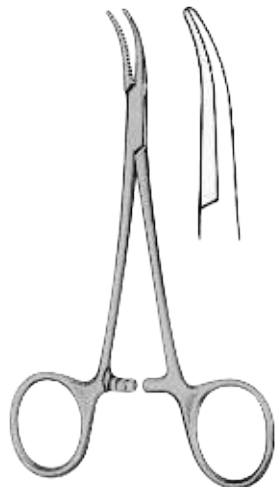

Mosquito-Dandy
SB-806-12
12cm/4 3/4"

Lateral Curved
Gekr ummte seitlichen
lat erale incurv ee
lateral curvo

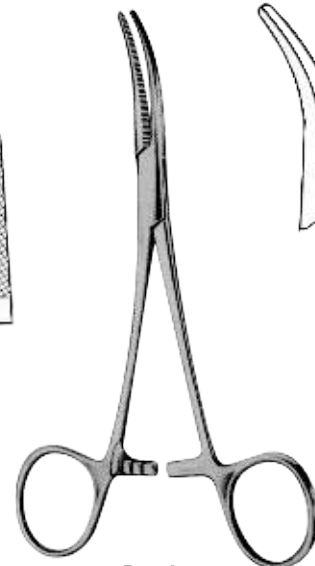

Dandy
14cm/5 1/2"

SB-807-14

SB-808-14

General Instruments

Hemostatic Dissecting and Ligature Forceps
Hämostatische Dissecting und Ligaturklemmen

Dissection Pince hémostatique et ligatures
La disección y pinzas hemostáticas ligaduras



Adson
18.5cm/7¼"

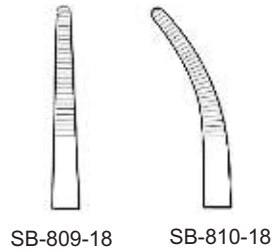

SB-809-18

SB-810-18

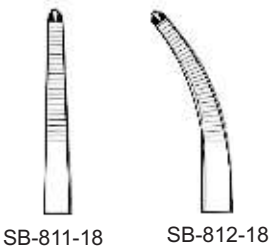

SB-811-18

SB-812-18

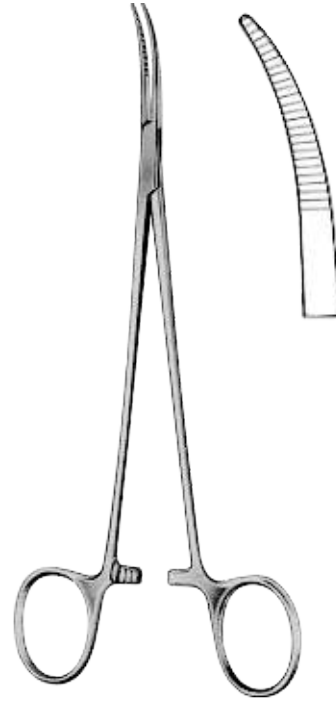

Nissen
SB-813-18 18.5cm/7 ¼"
SB-814-22 22.0cm/8 ¾"

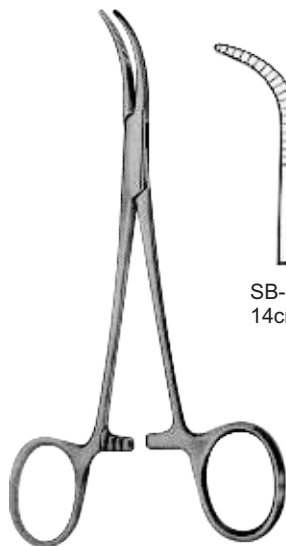

Baby-Adson



SB-815-14
14cm/5½"

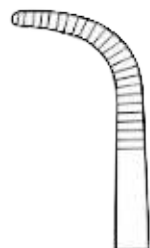

SB-816-18
18cm/7"

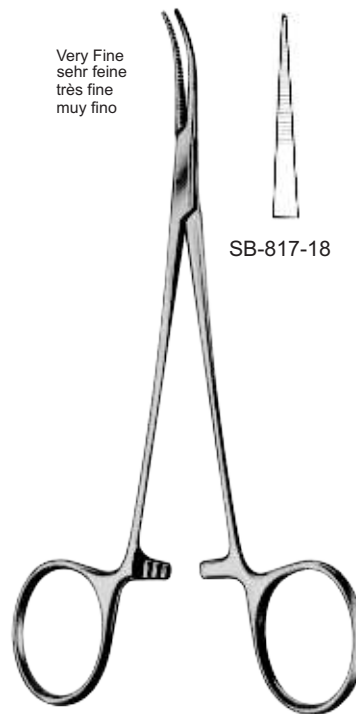

Jacobson-Adson
18cm/7"

Very Fine
sehr feine
très fine
muy fino

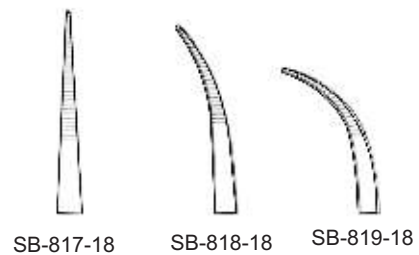

SB-817-18

SB-818-18

SB-819-18

General Instruments

Hemostatic Forceps
Arterienklemmen

pincas hémostatiques
pinzas hemostáticas



Lovelace
SB-820-15
15.5cm/6"

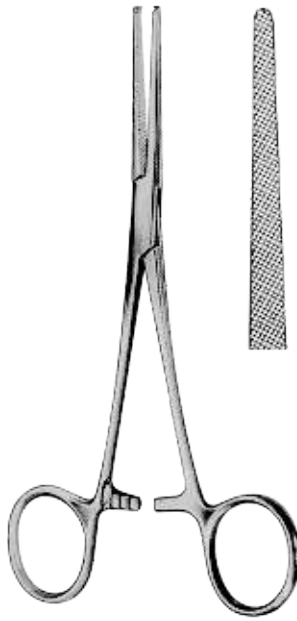

Dixon-Lovelace
SB-821-16
16cm/6¼"

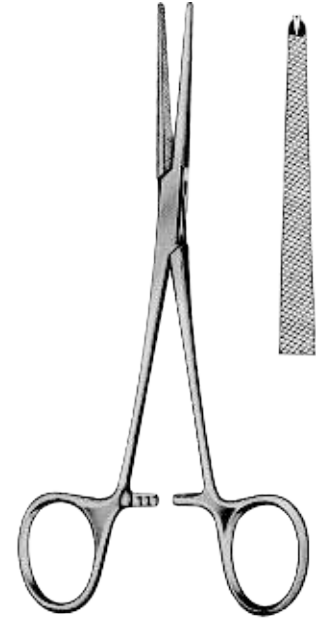

Dixon-Lovelace
SB-822-16
16cm/6¼"



Bainbridge
15cm/6"
18cm/7"



SB-823-15
SB-823-18



SB-824-15
SB-824-18

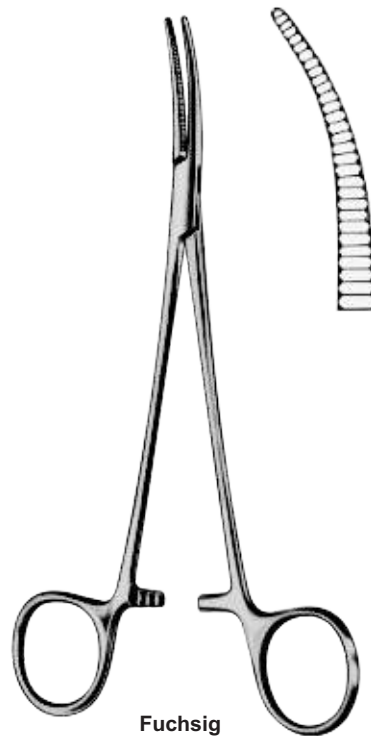

Fuchsig
SB-825-19
19cm/7½"

General Instruments

Hemostatic Forceps
Arterienklemmen

pincas hémostatiques
pinzas hemostáticas



Schnidt
19cm/7½"



SB-826-19

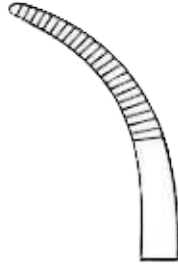

SB-827-19

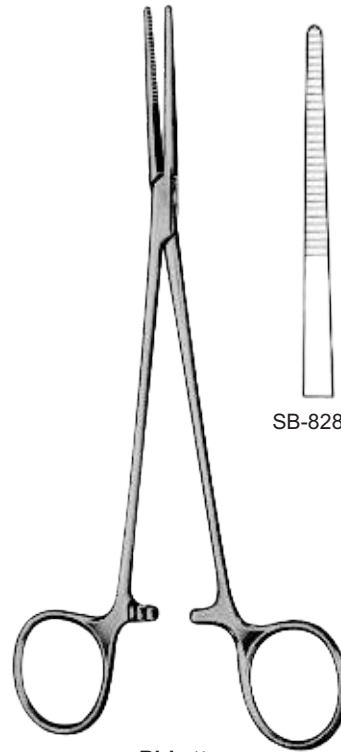

Birkett
19cm/7½"



SB-828-19



SB-829-19



Bengolea



20cm/8"

SB-830-20



22cm/8¾"

SB-830-22

SB-831-20

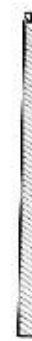

24cm/9½"

SB-830-24

SB-831-24

SB-832-20



26cm/10¼"

SB-830-26

SB-831-26

SB-832-24

SB-833-20

SB-832-22

SB-832-26

SB-833-22

SB-833-24

SB-833-26

General Instruments

Hemostatic Forceps
Arterienklemmen

pincas hémostatiques
pinzas hemostáticas



Bridge
27cm/10½"

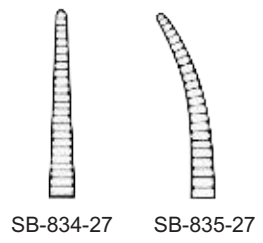

SB-834-27 SB-835-27



Roberts
22cm/8¾"

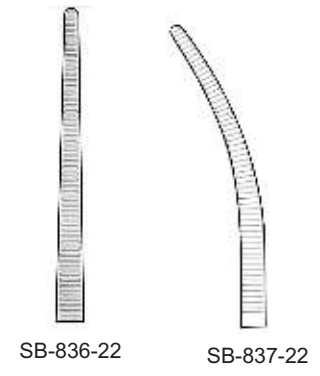

SB-836-22 SB-837-22



Kelly

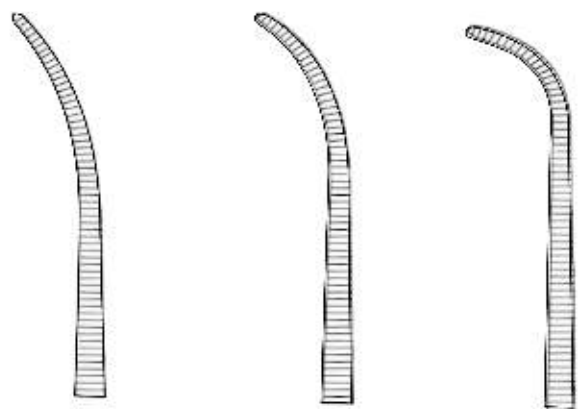

19cm/7½"	SB-838-19	SB-839-19	SB-840-19
22cm/8¾"	SB-838-22	SB-839-22	SB-840-22
24cm/9½"	SB-838-24	SB-839-24	SB-840-24

General Instruments

Bronchus and Hemostatic Forceps
Bronchien und Arterienklemmen

Pince hémostatique des bronches et
Pinzas de bronquios y hemostático



SB-841-24



SB-842-24

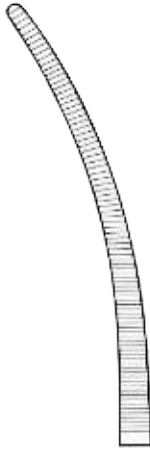

Sarot
24cm/9½"

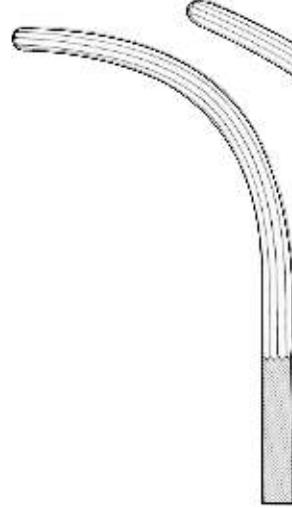

SB-843-22
22cm/8¾"



SB-844-23
23cm/9"



SB-845-24
24cm/9½"

Crafoord-Sellers



Crafoord
SB-846-18 18cm/7"
SB-846-24 24cm/9½"

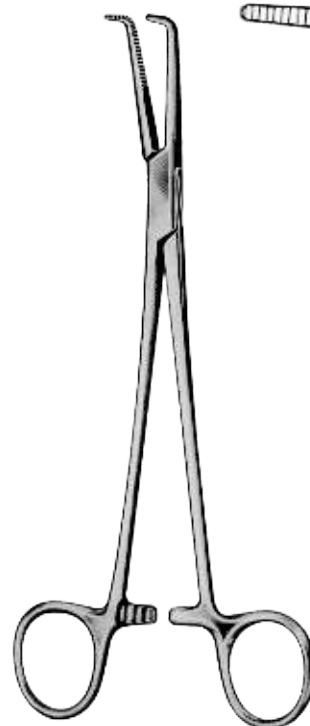
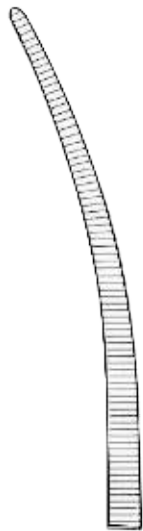

Kantrowitz
SB-847-19 19cm/7½"
SB-847-24 24cm/9½"
SB-847-26 26.5cm/10½"

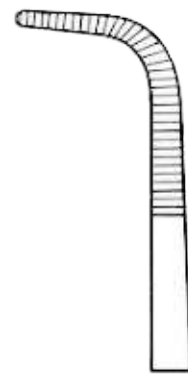

General Instruments

Dissecting and Ligature Forceps
Anatomische und Ligaturklemmen

Dissection et Pince Ligatures
Pinzas de disección y ligadura

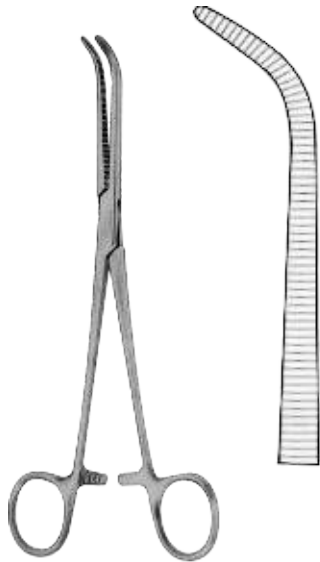

Johns Hopkins
SB-848-20
20cm/8"

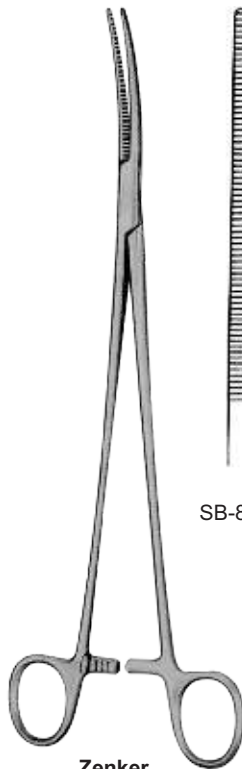

Zenker
29.5cm/11½"

SB-849-29



SB-850-29

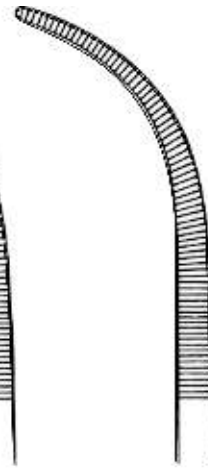

SB-851-29

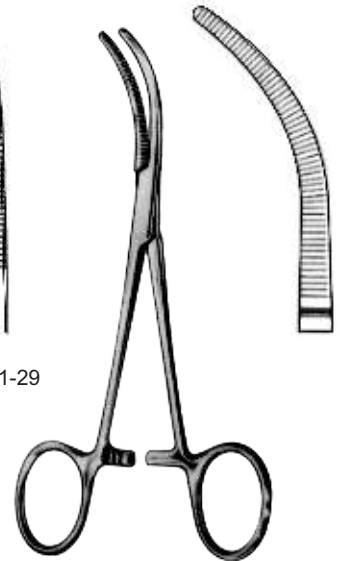

Baby-Overholt
SB-852-13
13.5cm/5¼"



Rumel
23cm/9"



SB-853-23



SB-854-23



SB-855-23

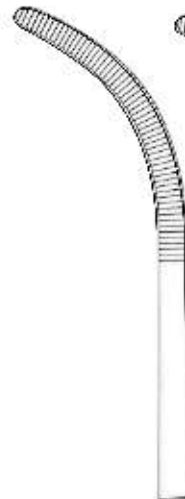

SB-856-23

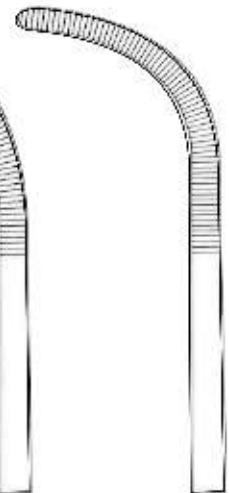

SB-857-23

General Instruments

Dissecting and Ligature Forceps
Anatomische und Ligaturklemmen

Dissection et Pince Ligatures
Pinzas de disección y ligadura

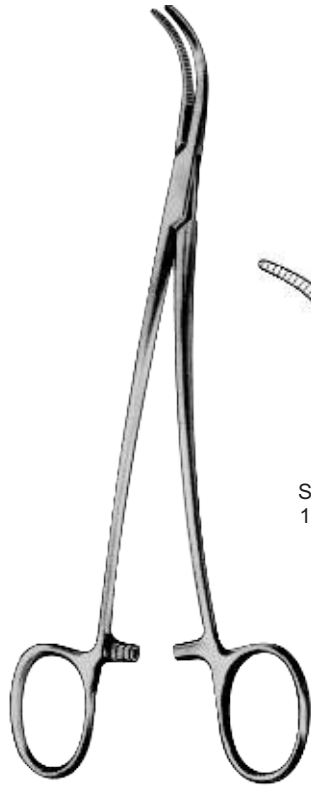

Overholt-Slim



SB-858-18
18.5cm/7 1/4"

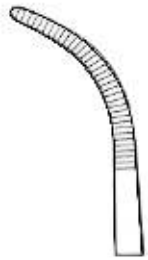

SB-859-20
20.5cm/8"

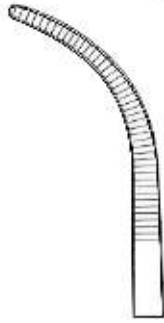

SB-860-21
21cm/8 1/4"

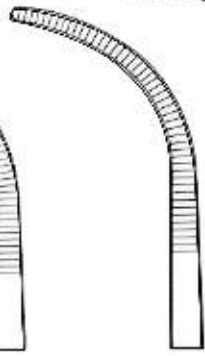

SB-861-21
21.5cm/8 1/2"



SB-862-24
24cm/9 1/2"



Overholt-Slim



SB-863-18
18.5cm/7 1/4"



SB-864-20
20.5cm/8"



SB-865-21
21cm/8 1/4"

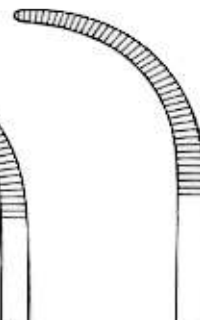

SB-866-21
21.5cm/8 1/4"



General Instruments

Dissecting and Ligature Forceps
Anatomische und Ligaturklemmen

Dissection et Pince Ligatures
Pinzas de disección y ligadura



Overholt-Geissendorfer
21cm/8¼"
27cm/10½"

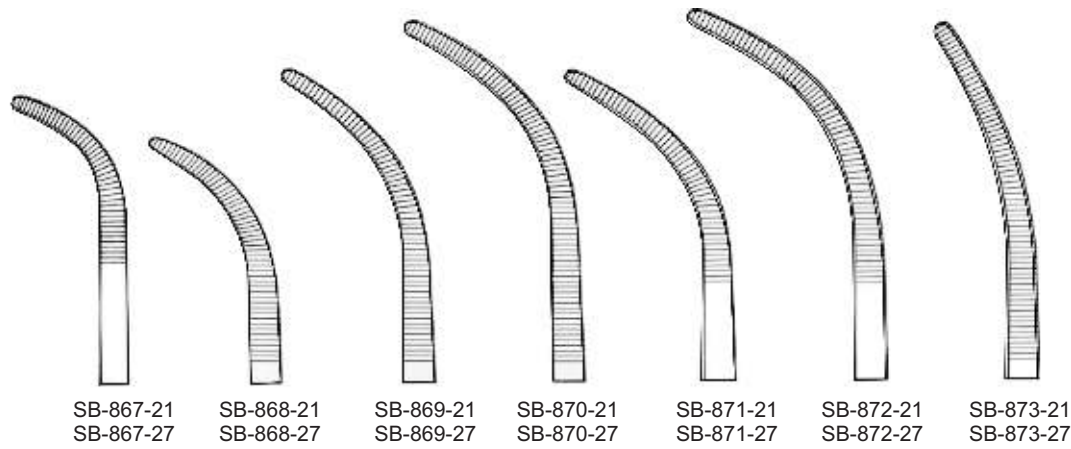

SB-867-21
SB-867-27

SB-868-21
SB-868-27

SB-869-21
SB-869-27

SB-870-21
SB-870-27

SB-871-21
SB-871-27

SB-872-21
SB-872-27

SB-873-21
SB-873-27



Overholt-Mixter
SB-874-21
21cm/8¼"

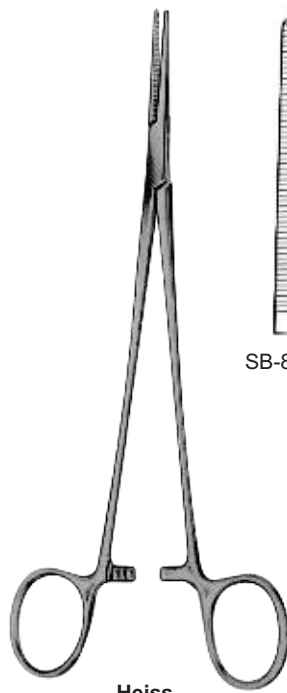
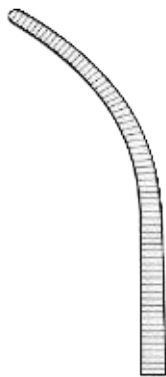

Heiss
20cm/8"

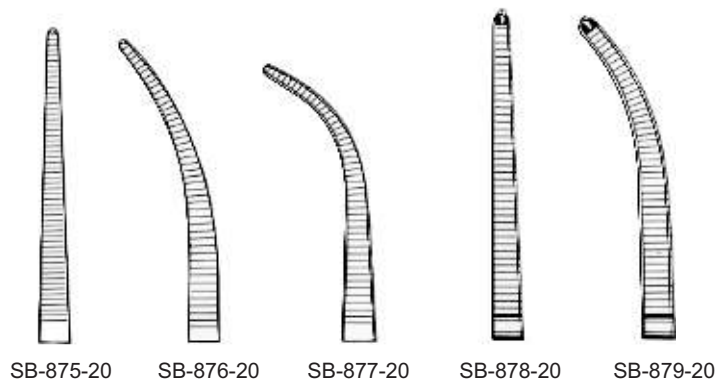

SB-875-20

SB-876-20

SB-877-20

SB-878-20

SB-879-20

General Instruments

Dissecting and Ligature Forceps
Anatomische und Ligaturklemmen

Dissection et Pince Ligatures
Pinzas de disección y ligadura



Meeker
SB-880-27
27 cm/10"

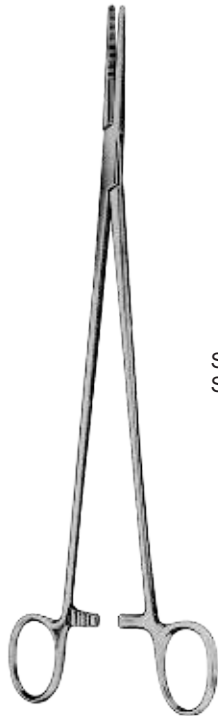

Toennis
21 cm/8¼"
26 cm/10¼"

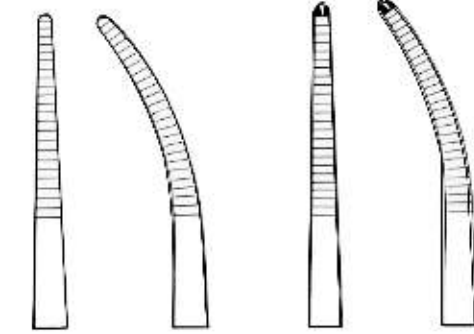

SB-881-21 SB-882-21 SB-883-21 SB-884-21
SB-881-26 SB-882-26 SB-883-26 SB-884-26



Lower
SB-885-18
18 cm/7"



Gemini

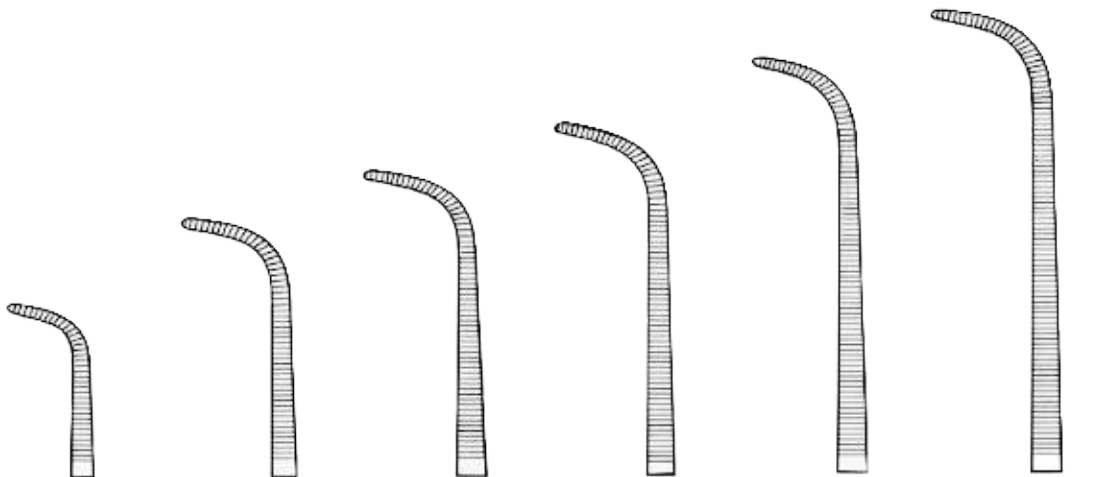

SB-886-13 SB-887-18 SB-888-20 SB-889-23 SB-890-25 SB-891-28
13 cm/5" 18 cm/7" 20 cm/8" 23 cm/9" 25 cm/10" 28 cm/11½"

General Instruments

Dissecting and Ligature Forceps
Anatomische und Ligaturklemmen

Dissection et Pince Ligatures
Pinzas de disección y ligadura



Mini-Gemini

SB-892-18
18 cm/7"

SB-893-22
22 cm/8¾"

SB-894-25
25 cm/10"

SB-895-28
28 cm/11"

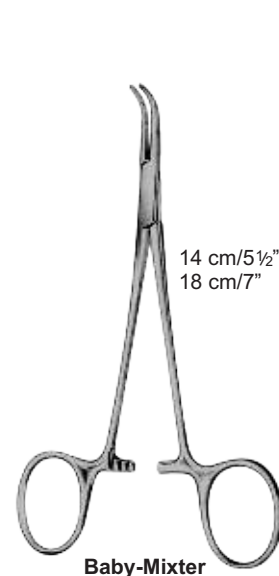

Baby-Mixer

14 cm/5½"
18 cm/7"

SB-896-14
SB-896-18

SB-897-14
SB-897-18



Mixer

SB-898-15 15 cm/6"
SB-898-19 19 cm/7½"

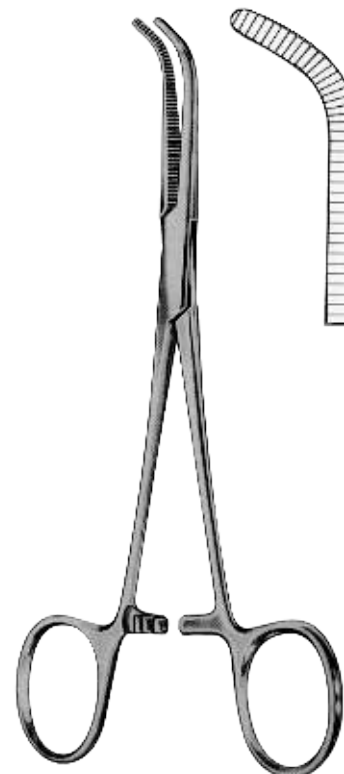

Mixer-O'Shaughnessy

SB-899-15 15.5 cm/6"
SB-899-19 19.0 cm/7½"

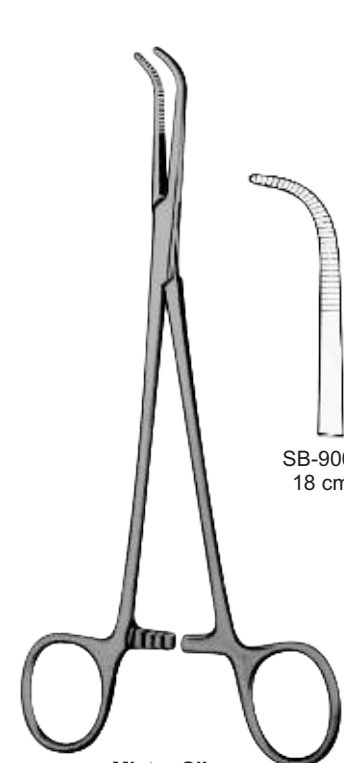

Mixer-Slim

SB-900-18
18 cm/7"

SB-901-23
23 cm/9"

General Instruments

Dissecting, Ligature Forceps and Gall Stone Clamps

Anatomische, Faden-Pinzetten und Klemmen Gallenstein

Pinces à disséquer ligature et colliers en pierre Gall

Pinzas de disección, ligadura y abrazaderas de cálculos biliares



Mixer

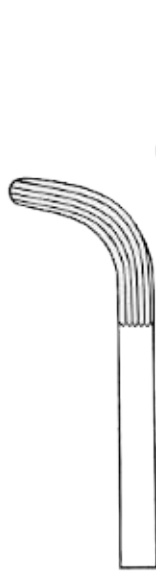

SB-902-22
22 cm/8¾"

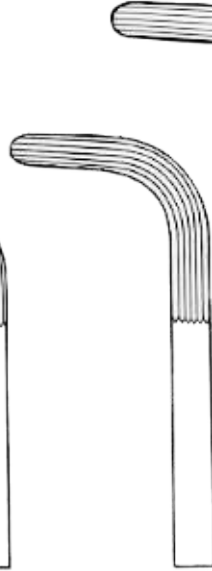

SB-903-25
25 cm/10"

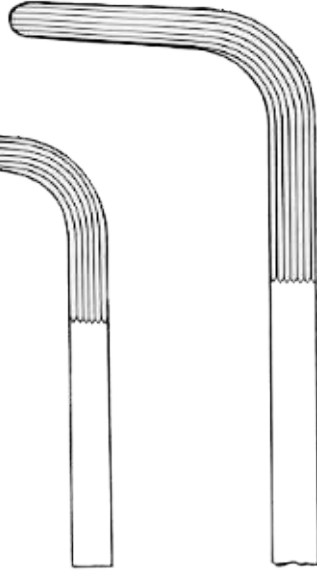

SB-904-28
28 cm/11"



Mixer

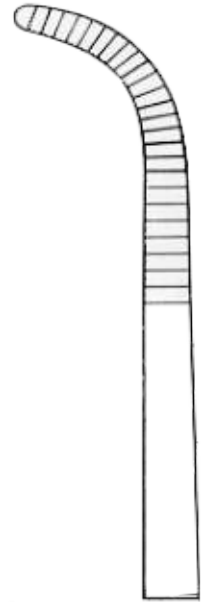

SB-905-22
22 cm/8¾"



Wickstroem
SB-906-20
20 cm/8"

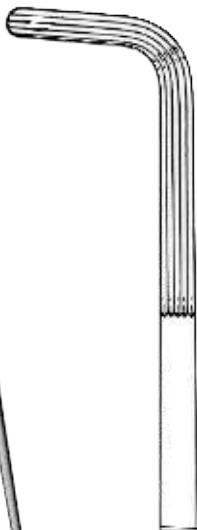

Finocchio
SB-907-24
24 cm/9½"

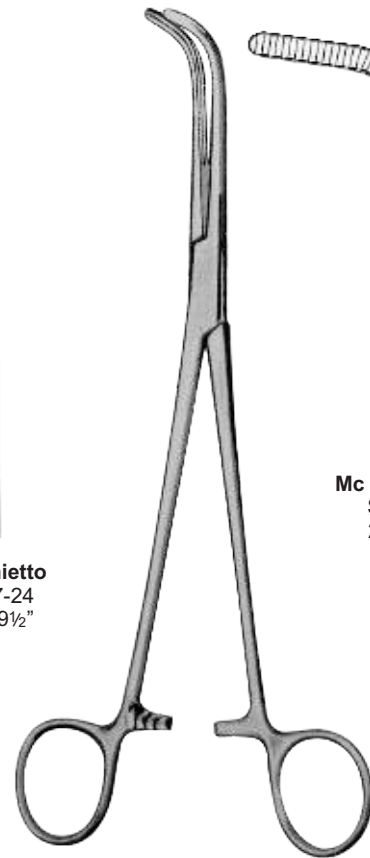

Mc Quigg-Mixer
SB-908-22
22 cm/8¾"

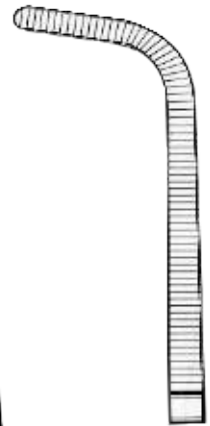

General Instruments

Dissecting, Gall Duct Clamps and Hemostatic Forceps
Zergliedern, Gallenwegefunktionsstörungen Klemmen und Arterienklemmen

Pinces à dissection Gall, de conduits et des pinces hémostatiques
Diseción, Gall conducto abrazaderas y pinzas hemostáticas



Lawrence
SB-909-27
27.5 cm/10¾"



Lahey (Sweet)

SB-910-19
19 cm/7½"



SB-911-23
23 cm/9"



Spencer-Wells

SB-912-13 13 cm/5"
SB-912-14 14 cm/5½"
SB-912-15 15 cm/6"
SB-912-18 18 cm/7"
SB-912-20 20 cm/8"
SB-912-23 23 cm/9"

SB-913-13
SB-913-14
SB-913-15
SB-913-18
SB-913-20
SB-913-23

General Instruments

Parametrium and Hysterectomy Forceps
Parametrium und Hysterektomie Zange

Pince paramètre et hystérectomie
Parametrio y Histerectomía Pinzas

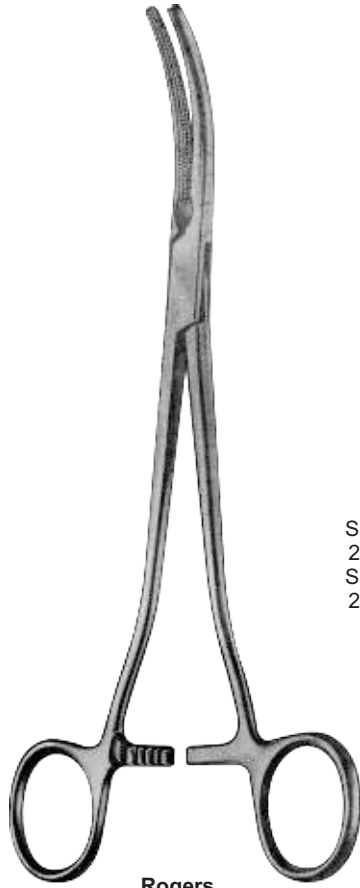

Rogers

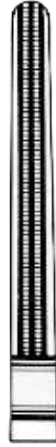

SB-914-22
22.5 cm/9"
SB-914-25
25.0 cm/10"

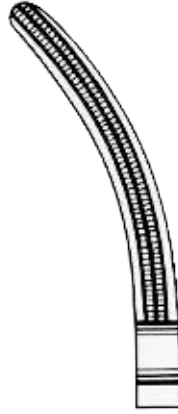

SB-915-22
22.0 cm/8¾"
SB-915-24
24.5 cm/9¾"

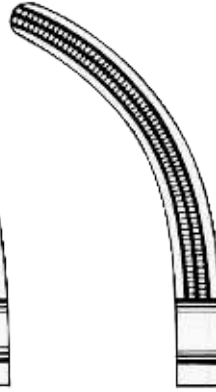

SB-916-21
21.5 cm/8½"
SB-916-24
24.0 cm/9½"

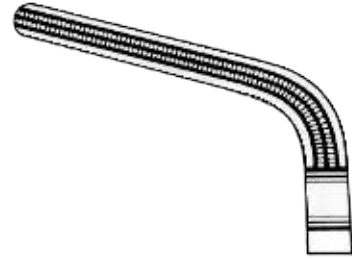

SB-917-20
20.5 cm/8"
SB-917-23
23.5 cm/9"



Heaney



19.5 cm/7½" SB-918-19
21.5 cm/8¼" SB-918-21
23.5 cm/9" SB-918-23



SB-919-19
SB-919-21
SB-919-23

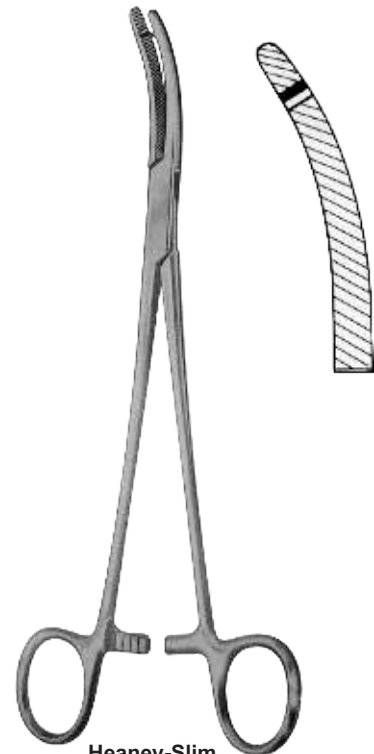

Heaney-Slim
SB-920-21
21 cm/8¼"

General Instruments

Hysterectomy Forceps
Hysterectomy Zange

Zange Hysterectomy
Hysterectomy Zange



Ballentine
SB-921-21
21cm/8¼"



Heaney-Ballentine
SB-922-21
21cm/8¼"



Tonsil Forceps
Pince amygdales
Pinzas de amígdalas

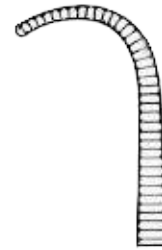
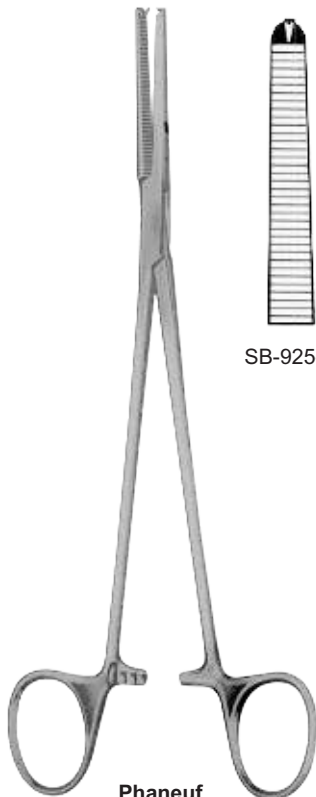

Fig. 1



Fig. 2

Negus
SB-923-19 19cm/7½" SB-924-19



Phaneuf
21.5cm/8½"



SB-925-21

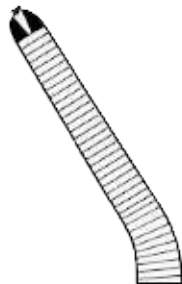

SB-926-21

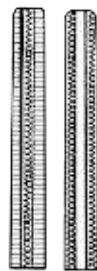

16cm/6¼" SB-927-16
20cm/8" SB-927-20

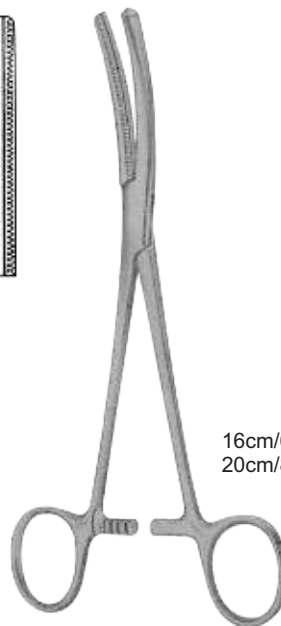

Fergusson

Haemorrhoidal Clamps
Hämorrhoiden Clamps
Pincés hémorroïdales
Abrazaderas hemorroidales

Straight
gerade
droit
recto

Curved
Gebogene
courbé
Curvo

SB-928-16
SB-928-20

General Instruments

Clamp and Artery Forceps
Clamp und Arterienklemmen

Pince de serrage et de l'artère
Abrazadera y de la arteria Pinzas

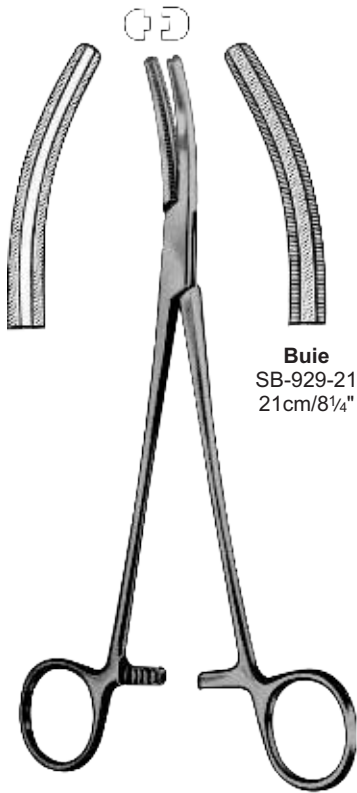

Buie
SB-929-21
21cm/8¼"

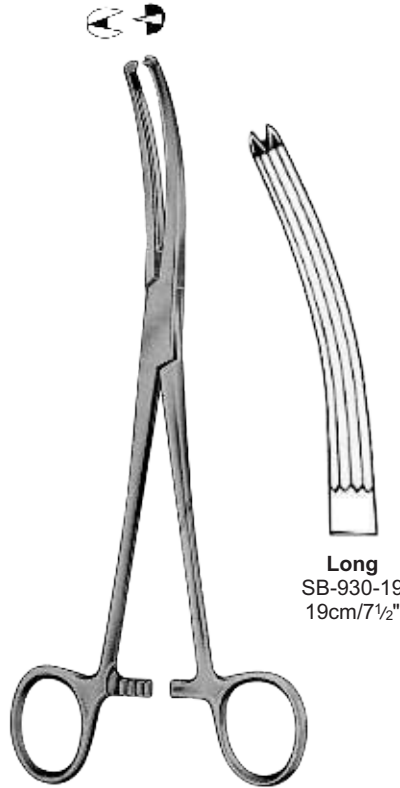

Long
SB-930-19
19cm/7½"

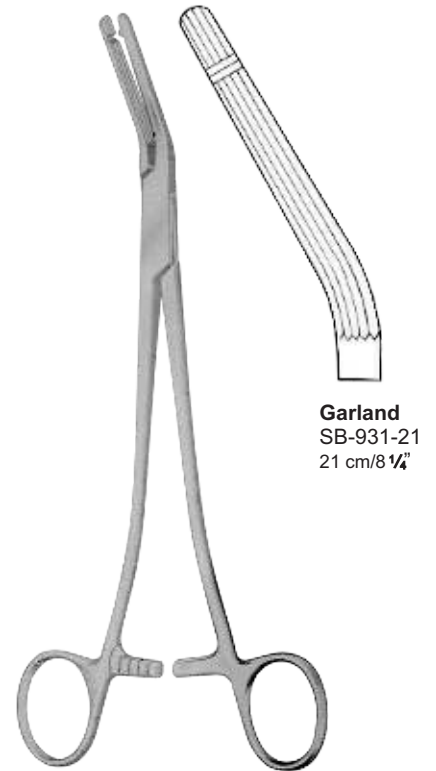

Garland
SB-931-21
21 cm/8 ¼"

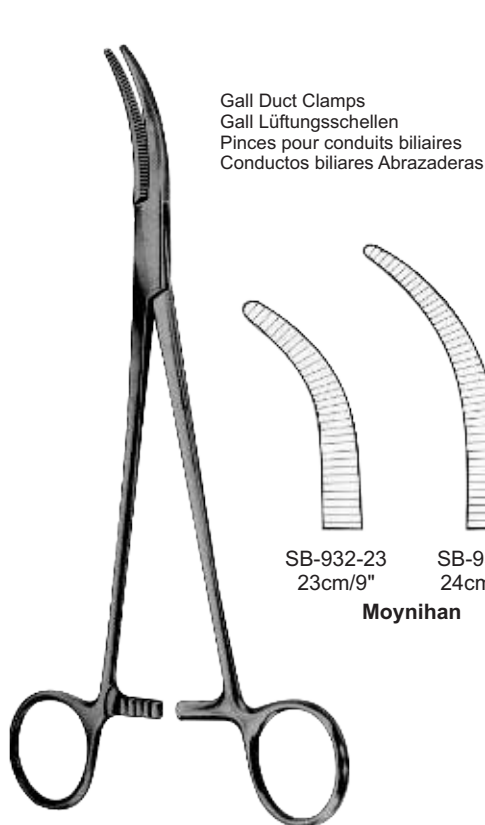

Gall Duct Clamps
Gall Lüftungsschellen
Pincas pour conduits biliaires
Conduitos biliares Abrazaderas

SB-932-23
23cm/9"

SB-933-24
24cm/9½"

Moynihan

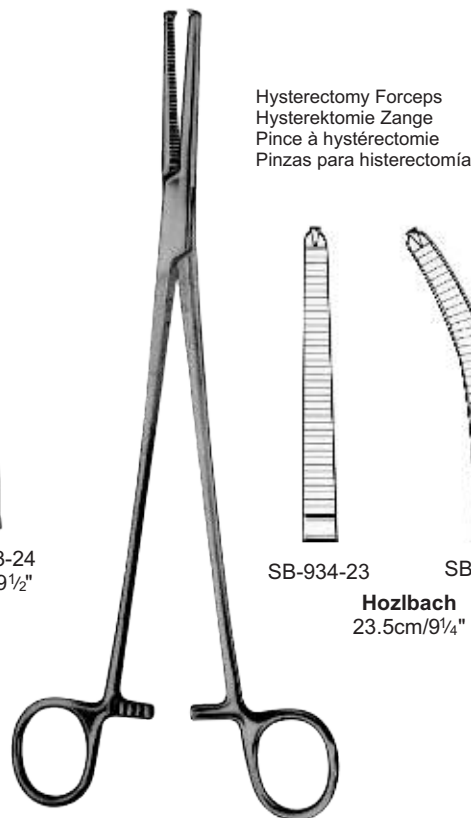

Hysterectomy Forceps
Hysterektomie Zange
Pince à hystérectomie
Pinzas para histerectomía

SB-934-23

SB-935-23

Hozlbach
23.5cm/9¼"



Pressure Clamps
Druckklemmen
Pincas de pression
Mordazas

Zweifel
SB-936-17
17.5cm/7"

General Instruments

Hysterectomy Clamp and Vaginal Forceps
Hysterektomie Clamp und Vaginal Forceps

Clamp hystérectomie et Vaginal Forceps
La histerectomía y la abrazadera Vaginal Forceps

Scalp Flap Forceps
Pinces à rabat cuir chevelu
Pinzas del cuero cabelludo Flap

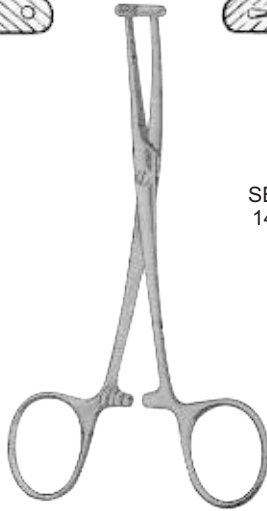

Martel
SB-938-14
14cm/5½"

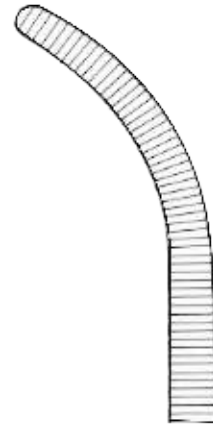

Werheim
SB-939-25
25cm/10"

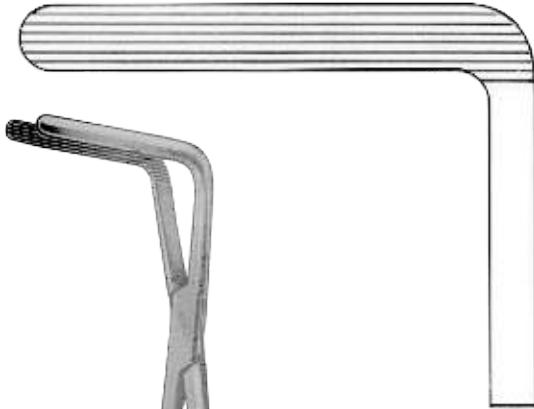

Werheim-Cullen
SB-940-21
21.5cm/8½"

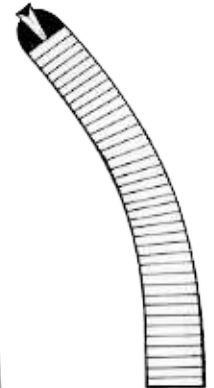

Extra Strong
extra Strong
extra Fuerte

Werheim
SB-941-24
24cm/9½"

General Instruments

Hysterectomy Clamp and Vaginal Forceps
Hysterektomie Clamp und Vaginal Forceps

Clamp hystérectomie et Vaginal Forceps
La histerectomía y la abrazadera Vaginal Forceps

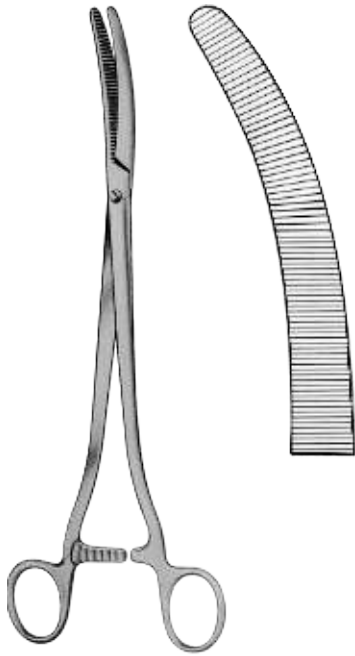

Faure
SB-942-25
25cm/10"



23cm/9"

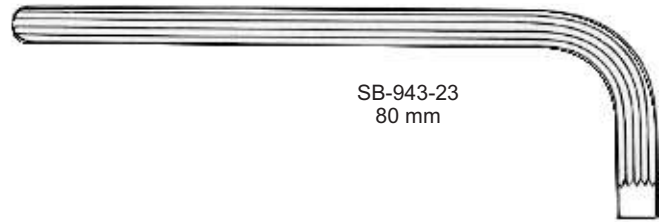

SB-943-23
80 mm

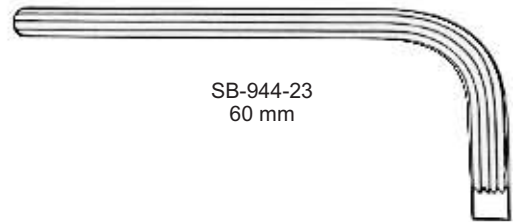

SB-944-23
60 mm



Wertheim
22cm/8¾"



SB-945-22
Slightly Curved
leicht gebogen
légèrement incurvé
Ligeramente curvada



SB-946-22
More Curved
mehr Curved
plus courbé
más curvo

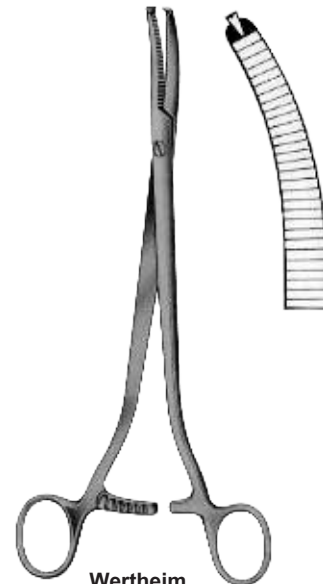

Wertheim
SB-947-22
22cm/8¾"

General Instruments

Peritoneal Clamp and Hysterectomy Forceps
Peritoneal Clamp und Hysterektomie Zange

Pince Forceps péritonéale et hystérectomie
Abrazadera peritoneal y pinzas histerectomía



Mikulicz
SB-948-18
18 cm/7"



Mikulicz
SB-949-20 20 cm/8" SB-950-20

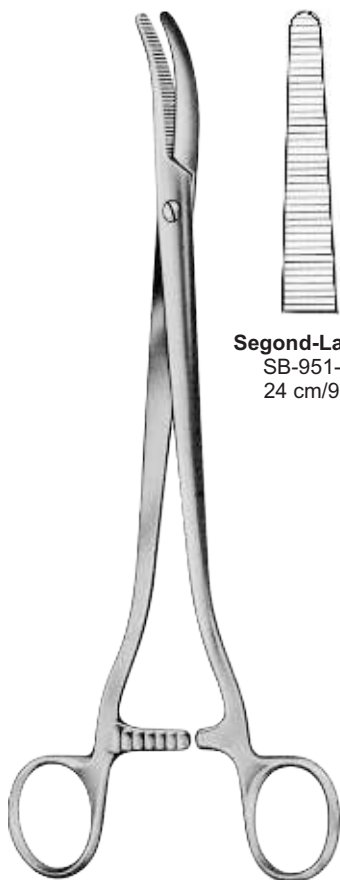

Segond-Landau
SB-951-24
24 cm/9½"



Segond
SB-952-24
24 cm/9½"



Faure
SB-953-20 20 cm/8" SB-954-20

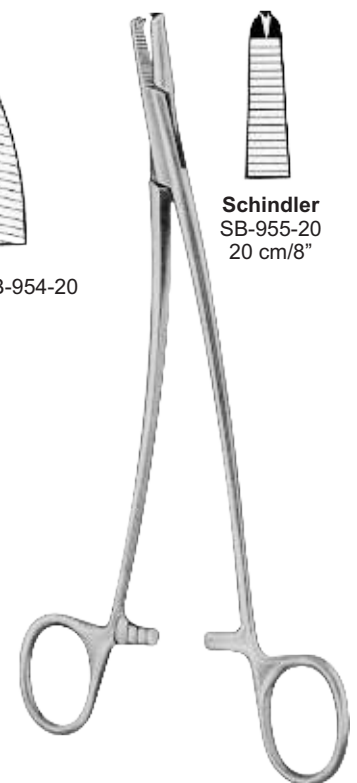

Schindler
SB-955-20
20 cm/8"

General Instruments

Peritoneal Clamp Forceps
Peritoneal Klammerzange

Pince de serrage péritonéale
Pinzas peritoneal Clamp

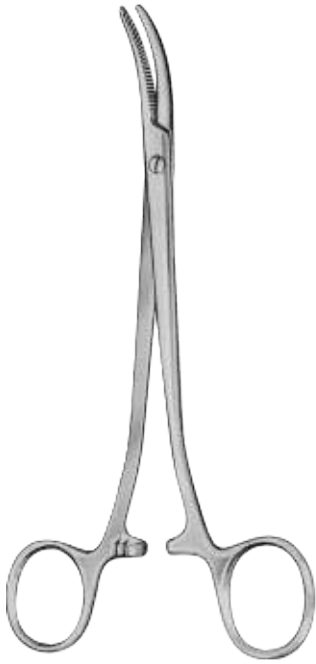

Werheim
SB-956-18
18 cm/7"

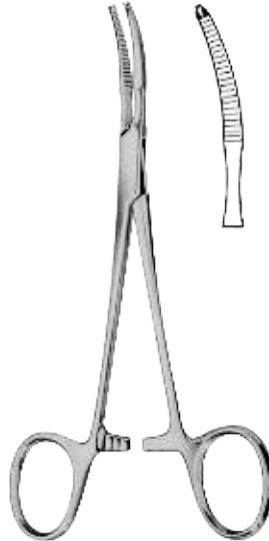

Baby-Mikulicz
SB-957-14
14 cm/5½"

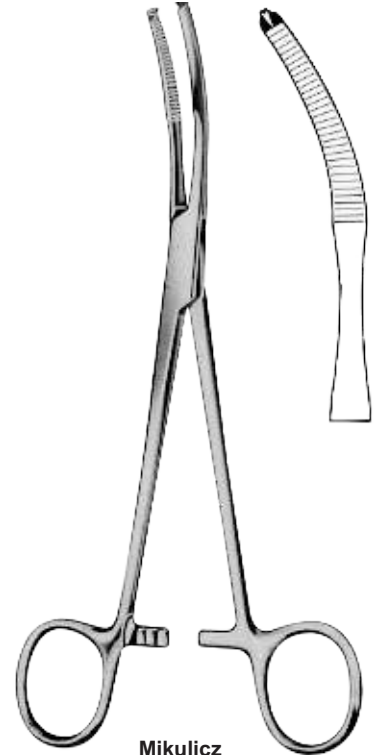

Mikulicz
SB-958-18 18cm/7"
SB-958-20 20cm/8"

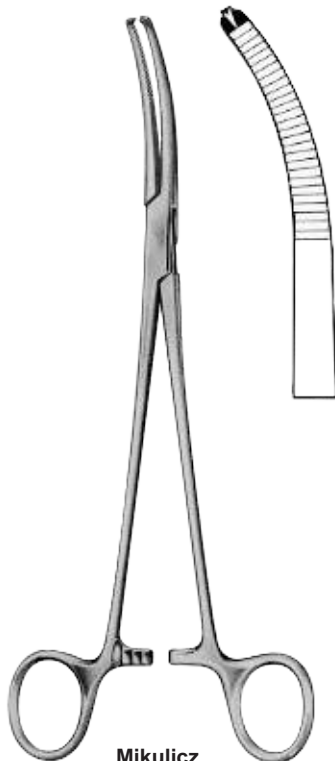

Mikulicz
SB-959-20
20 cm/8"

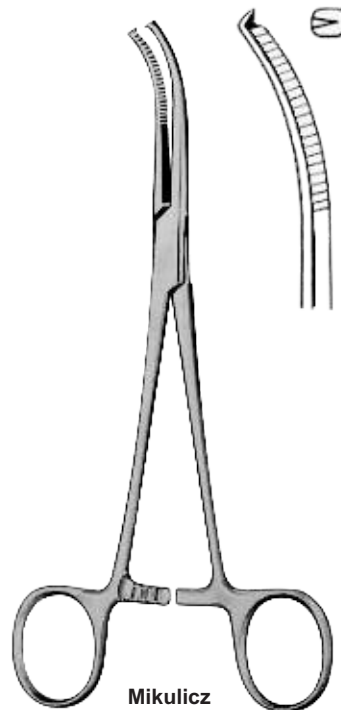

Mikulicz
SB-960-18
18.5 cm/7¼"

General Instruments

Towel Forceps
Tuchklemmen

Pince porte-serviettes
Pinzas de toallas



Schadel
SB-961-09
9 cm/3½"



Jones
SB-962-05 5 cm/2"
SB-962-09 9 cm/3½"



Engl-Modell
SB-963-09
9 cm/3½"



Backhaus
SB-964-09 9 cm/3½"
SB-964-11 11 cm/4 ½"
SB-964-13 13 cm/5"
SB-964-15 15 cm/6"

With clip for Tubing or Cable
Mit Clip für Schläuche oder Kabel
Avec clip pour tube ou câble
Con clip para tubos o cables



SB-965-11 11 cm/4 ½"
SB-965-13 13 cm/5"



Peers-Bertram
SB-966-14
14 cm/5 ½"

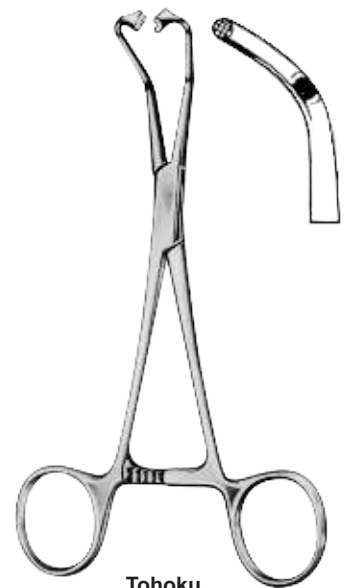

Tohoku
SB-967-10 10 cm/4"
SB-968-13 13 cm/5"

General Instruments

Towel Forceps
Tuchklemmen

Pince porte-serviettes
Pinzas de toallas

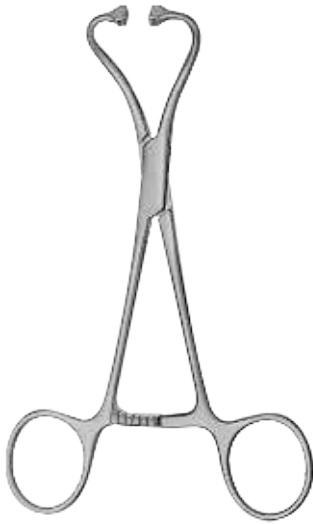

Ball and socket
SB-969-10 10 cm/4"
SB-969-13 13 cm/5¼"

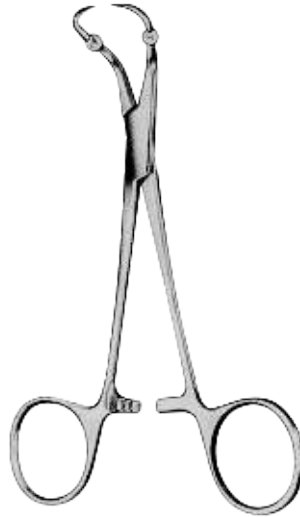

Roeder
SB-970-13 13 cm/5"
SB-970-15 15 cm/6"

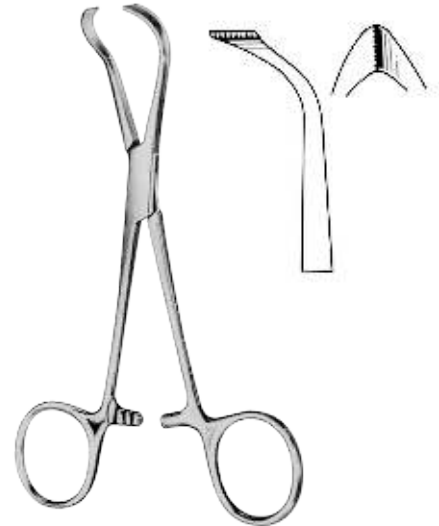

Lorna
SB-971-10 10 cm/4"
SB-971-13 13 cm/5"

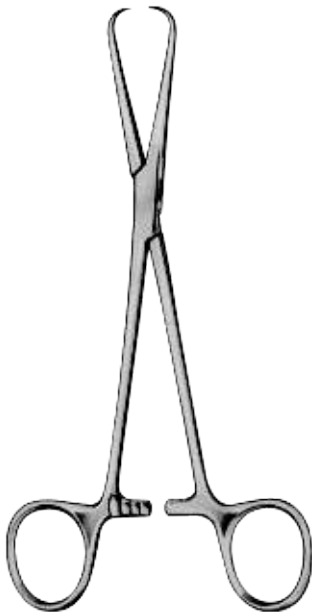

Bernhard
SB-972-16 16.5 cm/6½"



Lane
SB-973-13 13cm/5"
SB-973-15 15cm/6"
SB-973-18 18cm/7"
SB-973-20 20cm/8"
20 cm/8"



Doyen
SB-974-18
18 cm/7"

General Instruments

Tubing Forceps
Schläuche Pinzetten

Pince tubes
Pinzas de tubo

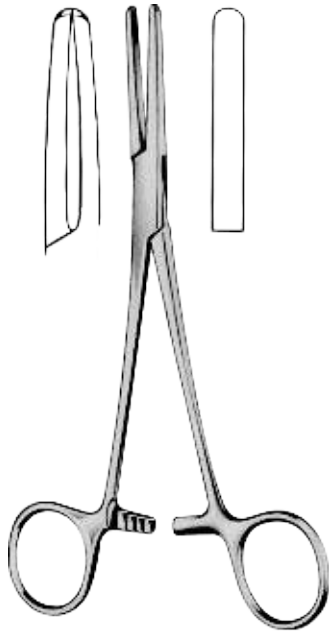

SB-975-14 14 cm/5 1/2"
SB-975-15 15 cm/6"
SB-975-18 18 cm/7"
SB-975-20 20 cm/8"

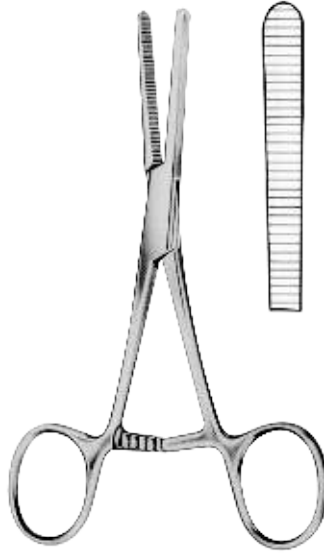

SB-976-14
14 cm/5 1/2"



SB-977-16 16.5 cm/6 1/2"
SB-977-18 18.0 cm/7"

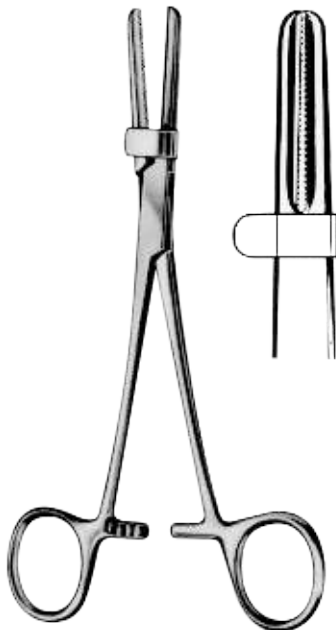

SB-978-15 15 cm/6"
SB-978-18 18 cm/7"
SB-978-20 20 cm/8"

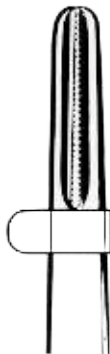

Mohr
SB-979-50 50 mm
SB-979-60 60 mm
SB-979-70 70 mm
SB-979-80 80 mm

Sizes
mm
13
17
20
25
30

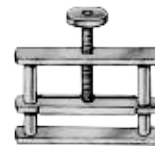

Hoffmann
SB-980-13
SB-980-17
SB-980-20
SB-980-25
SB-980-30



Hoffmann
SB-981-13
SB-981-17
SB-981-20
SB-981-25
SB-981-30



Serving Health Care

SPEED BIRD

ENTERPRISES



**161/C, SMALL INDUSTRIAL ESTATE
SIALKOT-51310, (PAKISTAN)**



: +92-304 0549944



: +92-52-3555584



: speed@birddent.com



: www.birddent.com