

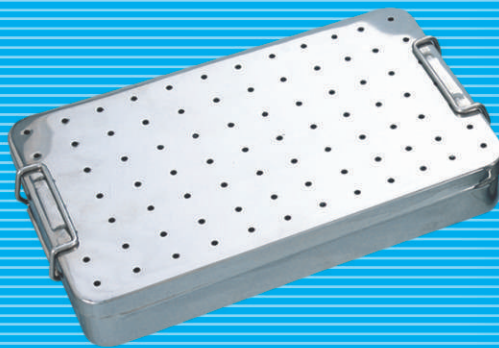

SPEED BIRD ENTERPRISES

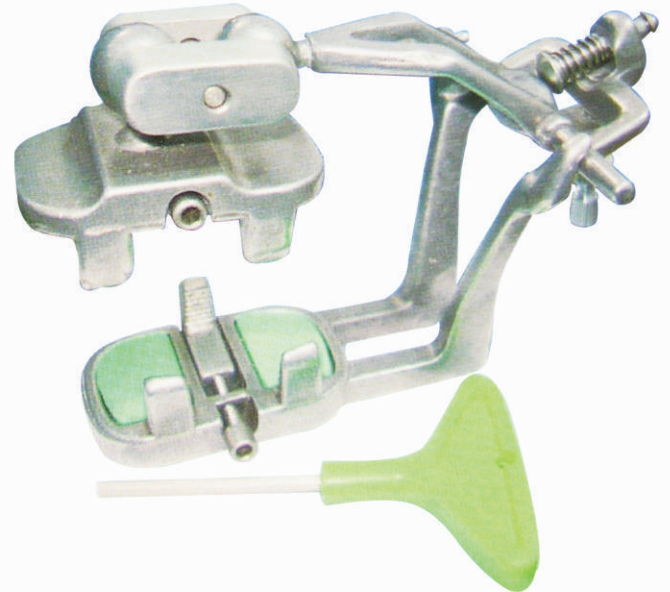

Articulators Plaster Less





SB-1168-04
 Articulator with a Ball Slot Type Path
 on The Maxillary Frame



SB-1168-05
 Anatomical Articulator ASA with
 Bearing Rod & Incisive Pin - Consructed
 of Metal Alloy Casting Available in
 Assorted Colors



SB-1168-06
 Articulator with Lateral Movement
 Made of Aluminum Die Casting with
 2 Mounting Plates also Available in
 Vibratory Polished Process & Assorted Colors

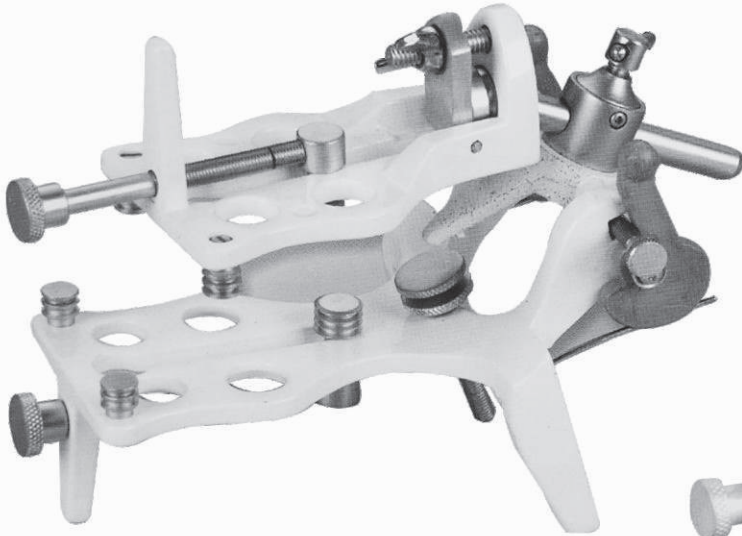

SB-1168-07
High Tech Plasterless Articulator
with Adjustable screws at Rears &
Front All anatomical Movement Possible

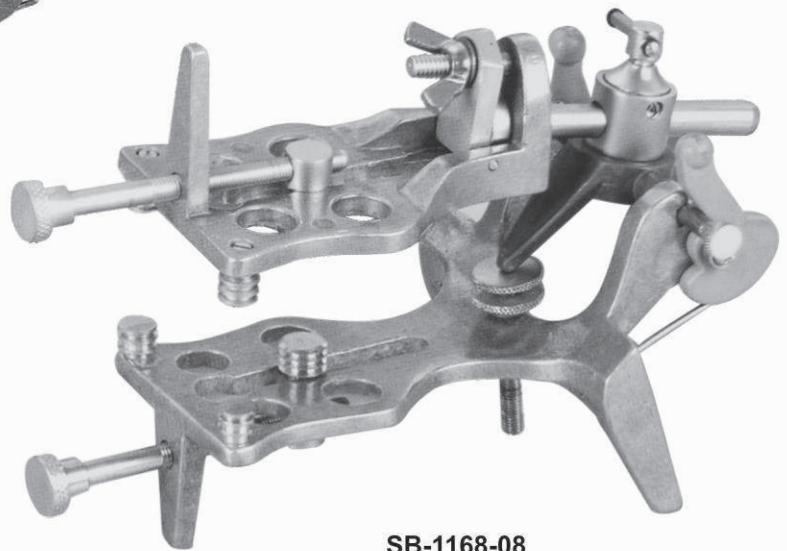

SB-1168-08
High Tech Plasterless Articulator
with Adjustable screws at Rears &
Front All anatomical Movement Possible
Also Available in Vibratory polished.



SB-1168-09



SB-1168-10

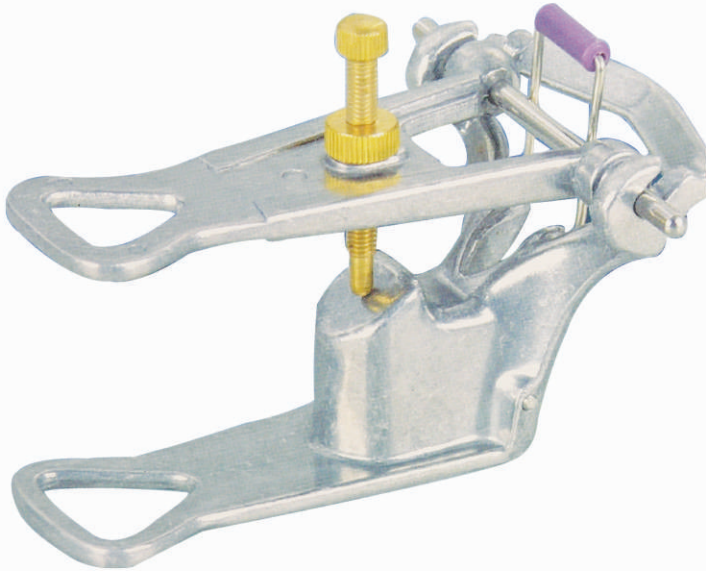

SB-1168-11
Professional Occlusor, Vibratory
Polished Articulator



SB-1168-12
Professional Occlusor, Vibratory
Polished Articulator



SB-1168-13



SB-1168-14
Crown & Bridge Articulator

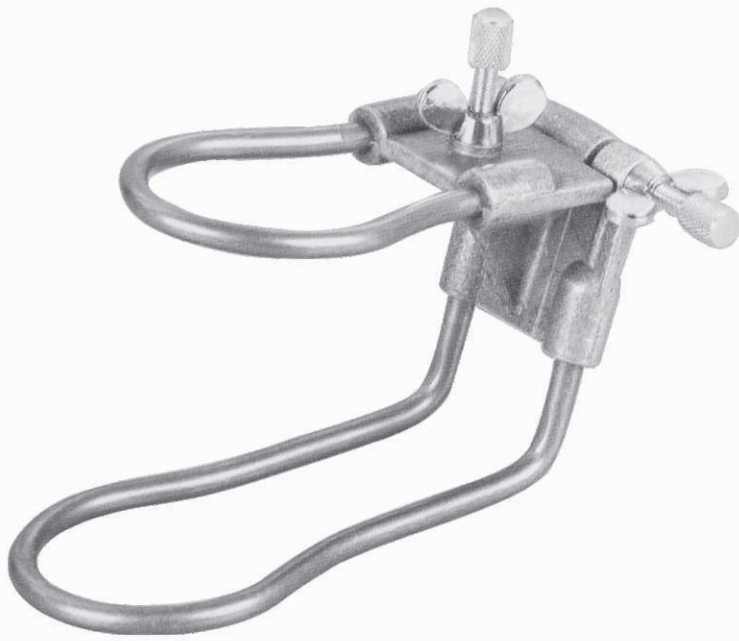

SB-1168-15
Vibratory Polished wire Articulator
Made of Stainless Steel & Die Cast Aluminum



SB-1168-16
Articulator
Chromium Plated



SB-1168-17
Articulator
Chromium Plated



SB-1168-18
Articulator 3-Slot
Chromium Plated

**SB-1168-19**

Mortimer-II Oculader Articulator
 Plainline Ball Bearing Mortimer-I Oculader
 Articulator Serri adjustable Articulator Allows
 The Establishment of more Accurate or
 Customised Lateral & Pretrusive As Well as
 Centric Occlusion. Also Available in Gold Plated

**SB-1168-20**

Mortimer-II Oculader Articulator
 Plainline Ball Bearing Mortimer-I Oculader
 Articulator All Filled with High Carbon Steel
 Balls for smooth setting & Articulation of
 Denture. Also Available in Gold Plated.

**SB-1168-21**

Mortimer-II Oculader Articulator
 Plainline Ball Bearing Mortimer-I Oculader
 Articulator All Filled with High Carbon Steel
 Balls for smooth setting & Articulation of
 Denture. Also Available in Gold Plated.

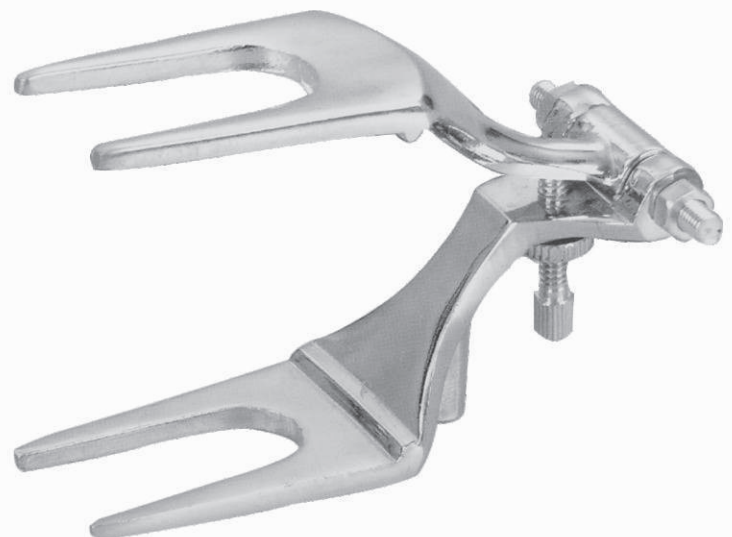
**SB-1168-22**

For Chromium Plated
 Crown & Bridge Articulator



SB-1169-01



SB-1169-02



SB-1169-03



SB-1169-04



SB-1169-05



SB-1169-06



SB-1169-07



SB-1169-08



SB-1170-01
Bracket Height Gauge
018



SB-1170-02
Bracket Height Gauge
022



SB-1170-03
Swivel Head
Bracket Height Gauge



SB-1170-04
Bracket Height Gauge



SB-1171-01
Iwanson Caliper
for Wax



SB-1171-02
Iwanson Caliper
for Metal



SB-1171-03
Iwanson Caliper
for Wax



SB-1171-04
Degree Gauge for Jewelry



SB-1171-05
Wide Jaw Lens Gauge Measures
up to 25mm Thick Lenses in
1/5mm Graduation 7 1/2" Long



SB-1172-01
Decimal Caliper
Measuring Range
0-100 mm



SB-1172-02
Decimal Caliper
Measuring Range
0-100 mm



SB-1172-03
Decimal Caliper
Measuring Range
0-100 mm



SB-1172-04
Decimal Caliper
Measuring Range
0-100 mm



SB-1172-05
Decimal Caliper
Measuring Range
0-100 mm



SB-1172-06
Decimal Caliper
Measuring Range
0-100 mm



SB-1173-12
Beerendonk, Sliding calipers
12.5cm



SB-1174-00
Beerendonk, Sliding calipers

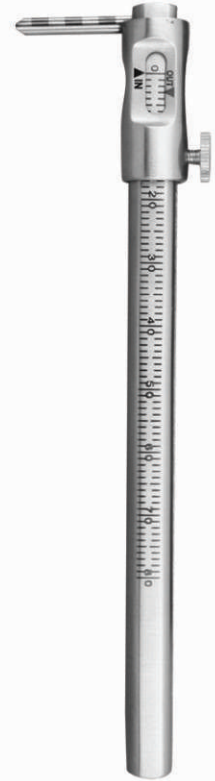

SB-1175-00
Sliding calipers
distance 1.5mm



SB-1176-00
Gauge
for measuring
distance 0.90 mm



SB-1177-00



SB-1178-00



SB-1178-00

Castroviejo Caliper



SB-1179-20
Castroviejo
20mm



SB-1180-00
Castroviejo
Measuring Loop
measuring range
0.40 mm



SB-1181-00
Castroviejo
Measuring divider
straight 15 mm



SB-1182-00
Castroviejo
Measuring divider
angled 20 mm



SB-1183-00
Clamp Osteometer
Length about 155mm
ridge width measurement
two sided scale measuring
range 0.25mm



SB-1184-01
Ermert
13 cm



SB-1184-02
Ermert
13 cm



SB-1185-01
Fig.1
Lessmann
13 cm



SB-1185-02
Fig.2
Lessmann
17 cm



SB-1186-01
Fig.1
Fahnenstock
13 cm



SB-1186-02
Fig.2
Fahnenstock
17 cm



SB-1187-01
Fig.1
with small spoon
12.5 cm



SB-1188-01
Fig.1
with small spoon
17 cm



SB-1189-01
Original Buffalo
No. 6



SB-1189-02
Original Buffalo
No. 7



SB-1190-01



SB-1191-01



SB-1192-01
Gritman



SB-1193-01



SB-1193-02



SB-1194-01



SB-1195-01

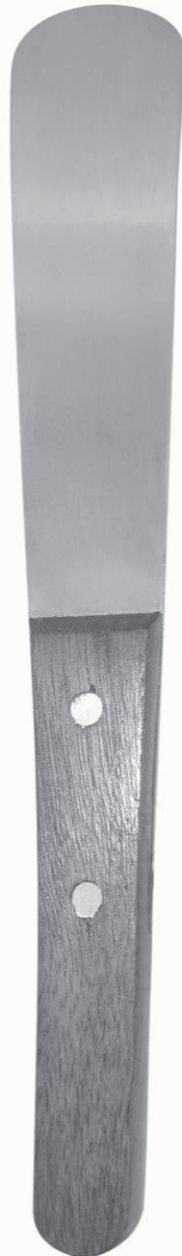

SB-1196-01



SB-1197-01
Lichtenstein



SB-1198-01



SB-1199-20
Instruments Cassette
Removable cover, Twist lock system
20 Instruments



SB-1200-10
Instruments Cassette
Removable cover, Twist lock system
10 Instruments

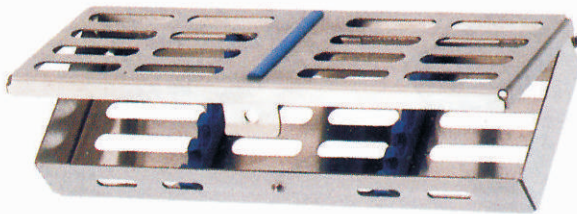

SB-1201-05
Instruments Cassette
5 Instruments

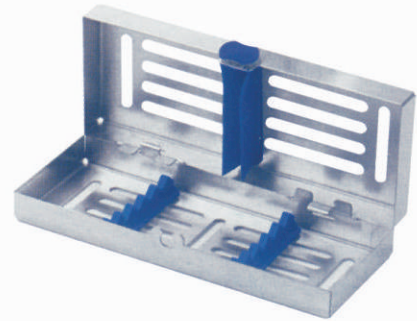

SB-1202-05
Instruments Cassette
Removable cover, Twist lock system
5 Instruments

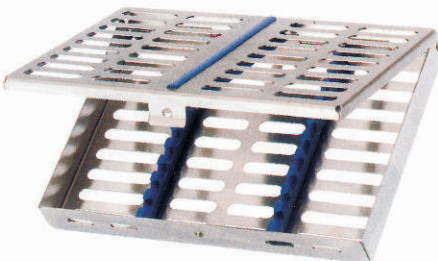

SB-1203-10
Instruments Cassette
10 Instruments

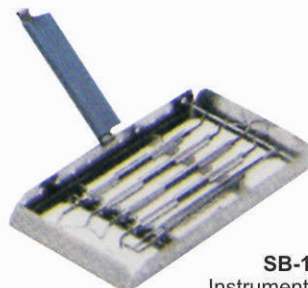

SB-1205-05
Instruments Cassette
05 Instruments

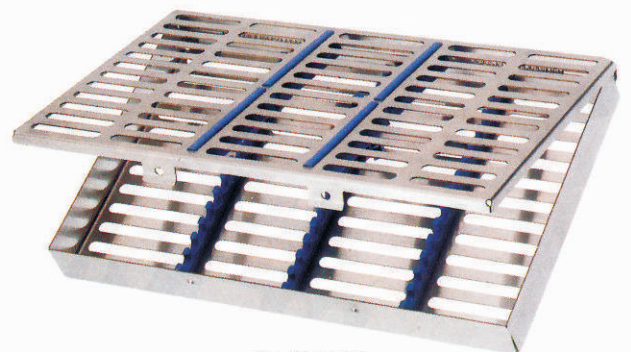

SB-1204-20
Instruments Cassette
20 Instruments



SB-1199-20
Instruments Cassette
Removable cover, Twist lock system
20 Instruments



SB-1200-10
Instruments Cassette
Removable cover, Twist lock system
10 Instruments

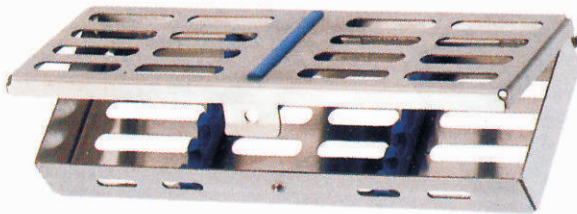

SB-1201-05
Instruments Cassette
5 Instruments

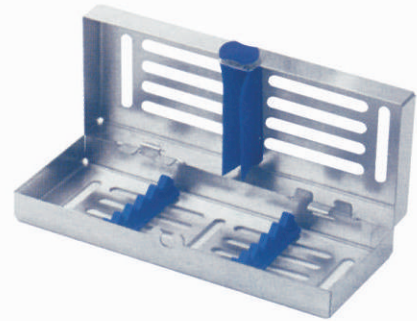

SB-1202-05
Instruments Cassette
Removable cover, Twist lock system
5 Instruments

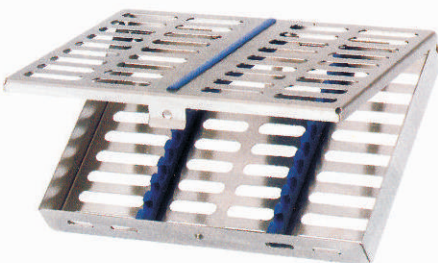

SB-1203-10
Instruments Cassette
10 Instruments

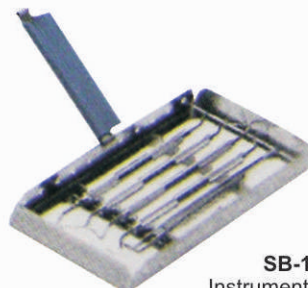

SB-1205-05
Instruments Cassette
05 Instruments

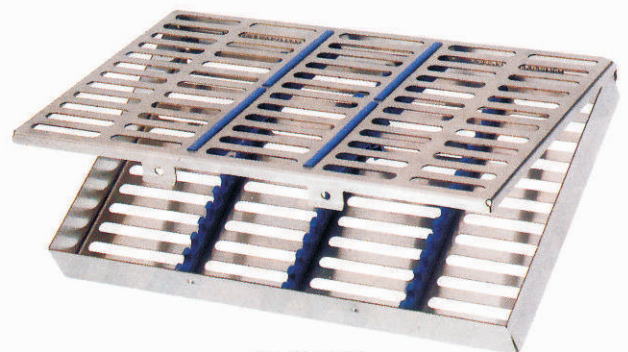

SB-1204-20
Instruments Cassette
20 Instruments



SB-1206-01
Stainless Steel Sterilizing
Box includes a Finger tip silicone
Mat insert to facilitate sterilization
of handpieces. Perforated top made
of stainless dimension 255x155x20mm



SB-1206-02
Stainless Steel Sterilizing
Box includes a Finger tip silicone
Mat insert to facilitate sterilization
of handpieces. Perforated top made
of stainless dimension 255x155x20mm



SB-1206-03
Made of Stainless Steel Silicone
Instruments Holder Medium Cassette
for 10 instruments Silicone is Available
in Assorted colors.
Dimension 188x135x22mm

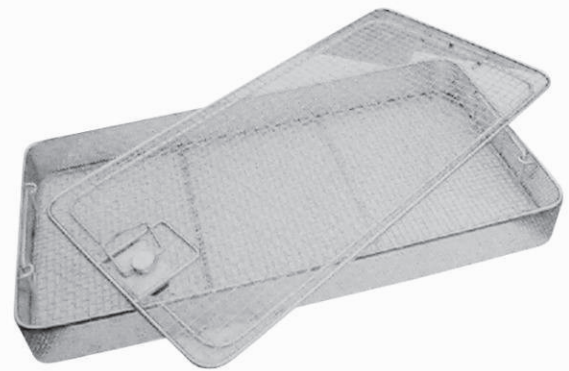

SB-1206-04
Sterilization Basket with
Cross-hatched Flat Based
Mesh, Lockable & removable
Dimension 480x228x55mm



SB-1206-05
Sterilization Basket with
Cross-hatched Flat
Based Mesh, Lockable & Removable lid.
Dimension 240x250x107mm

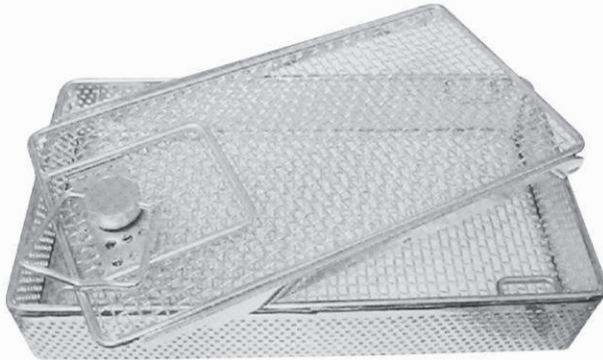

SB-1207-01
The Base is Crimped wire Mesh
with opening Mesh cross-hatched flat
Based Mesh and Perforated sides
and removable lid
Dimension 220x125x40mm



SB-1207-02
Instruments Tray
Dimension 240x130x50mm

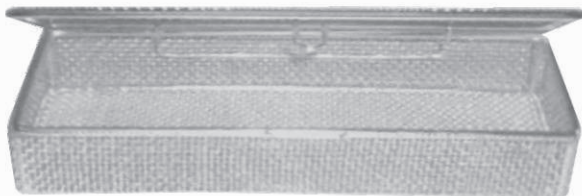

SB-1207-03
Instruments Tray
Dimension 230x80x40mm

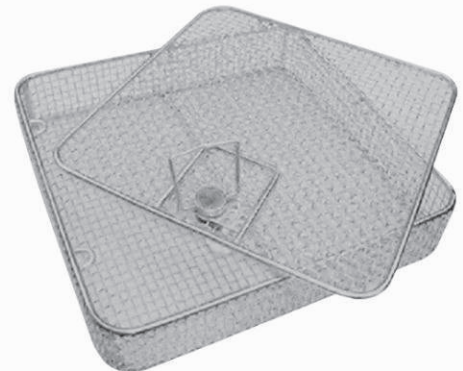

SB-1207-04
Sterilization Basket with
Cross-hatched Flat based
Mesh, Lockable & Removable
Dimension 240x250x57mm



SB-1207-05
Sterilization Basket with
Perforated Sides Crosshatched
Flat Based Mesh
without Lid
Dimension 250x235x50mm



SB-1207-06
Sterilization Basket with
Cross-hatched Flat based
Mesh, Lockable & Removable
Dimension 255x228x55mm

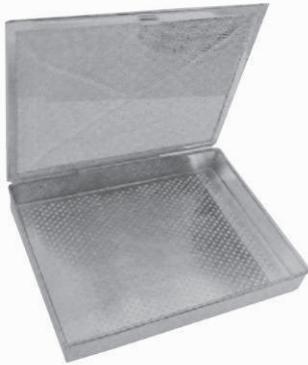

SB-1208-01
Solid Sides, Perforated
Base & Top is crimped
Wire Mesh with top opening
Dimension



SB-1208-02
Perforated Tray
288 x 187 x 40 mm
180 x 140 x 40 mm



SB-1208-03
Perforated Tray
288 x 187 x 40 mm
180 x 140 x 40 mm



SB-1208-04
Perforated Tray
288 x 187 x 40 mm
180 x 140 x 40 mm



SB-1208-05
Instruments Tray & Cover
8" x 6" x 2"
10" x 8" x 2"
12" x 7" x 2"



SB-1208-06
Instruments Tray
8" x 4" x 1"



SB-1208-07
Instruments Tray Perforated
12" x 6" x 1"

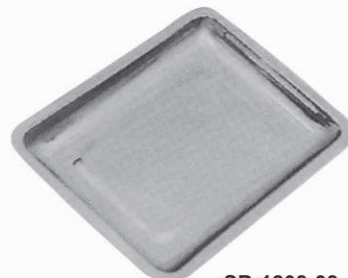

SB-1208-08
Instruments Tray Shallow Mayo
8" x 6" x 1"
9" x 6" x 1"
12" x 8" x 2"



SB-1208-09
Scaler Tray
200 x 100 x 15 mm
200 x 150 x 15 mm

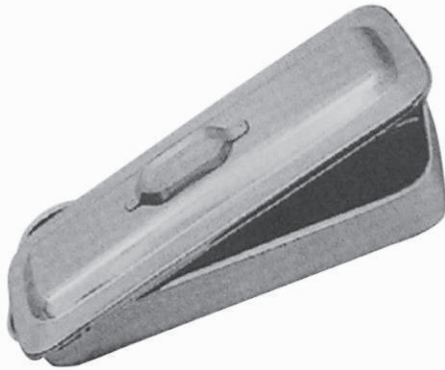

SB-1209-01
Catheter Tray
222 x 82 x 40 mm
225 x 125 x 50 mm
325 x 90 x 50 mm



Code	Size
SB-1210-01	17 x 7 x 3 cm
SB-1210-02	17.5 x 7.5 x 3 cm
SB-1210-03	18 x 6 x 3 cm
SB-1210-04	18 x 7 x 3 cm
SB-1210-05	18 x 9 x 4 cm
SB-1210-06	20 x 10 x 4 cm
SB-1210-07	21 x 10 x 4 cm

Instruments Boxes
in Different Sizes



SB-1211-01
Needle Case



SB-1212-01 (5 cc)
SB-1212-02 (2 cc)
Syringes Case



SB-1213-01
Finger Cup

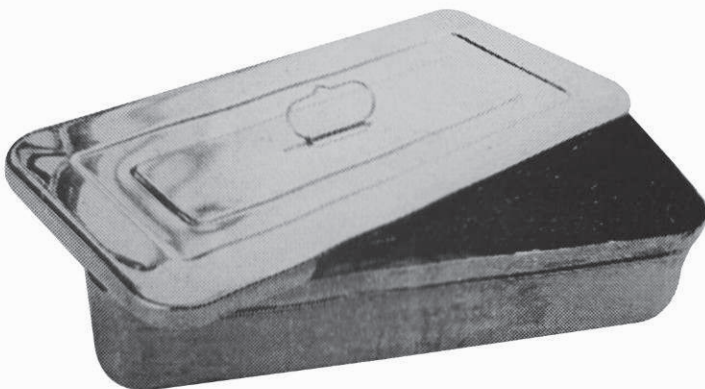

Code	Size
SB-1214-01	30 x 15 x 10 cm
SB-1214-02	30 x 17 x 5 cm
SB-1214-03	34 x 16 x 5 cm
SB-1214-04	36 x 24 x 5 cm
SB-1214-05	36 x 24 x 10 cm
SB-1214-06	40 x 20 x 6 cm

Instruments Boxes
in Different Sizes

Code	Size
SB-1215-01	40 x 20 x 10 cm
SB-1215-02	40 x 30x 5 cm
SB-1215-03	40 x 30x 10 cm
SB-1215-04	42 x 19 x 5 cm
SB-1215-05	42 x 30 x 5 cm
SB-1215-06	45 x 30 x 10 cm

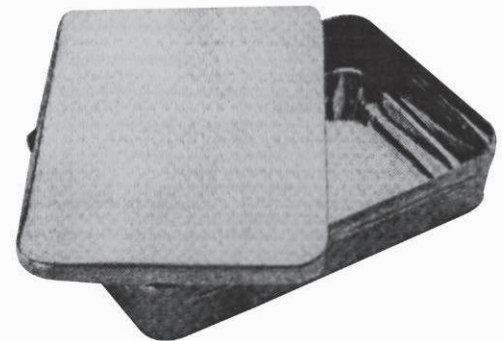

Code	Size
SB-1216-01	23 x 15x 5 cm
SB-1216-02	25 x 12x 5 cm
SB-1216-03	25 x 12x 10 cm
SB-1216-04	26 x 15 x 5 cm
SB-1216-05	30 x 15 x 5 cm
SB-1216-06	32 x 6 x 4 cm



SB-1217-01 27 x 12 x 6 cm
Sterilizer With Heater



Code	Size	Code	Size
SB-1218-01	24 x 12 cm	SB-1219-01	34 x 28 cm
SB-1218-02	30 x 15 cm	SB-1219-02	37 x 30 cm
SB-1218-03	30 x 30 cm	SB-1219-03	39 x 14 cm
SB-1218-04	34 x 16 cm	SB-1219-04	39 x 20 cm
SB-1218-05	34 x 24 cm	SB-1219-05	39 x 29 cm

Dressing/ Sterilizing Drum
in Different Sizes

Code	Size
SB-1220-01	8 x 8 cm
SB-1220-02	10 x 10 cm
SB-1220-03	12 x 12 cm
SB-1220-04	16 x 12 cm
SB-1220-05	18 x 18 cm
SB-1220-06	19 x 14 cm
SB-1220-07	19 x 20 cm
SB-1220-08	20 x 16 cm
SB-1220-09	20 x 20 cm
SB-1220-10	24 x 16 cm
SB-1220-11	24 x 24 cm
SB-1220-12	29 x 14 cm
SB-1220-13	29 x 16 cm
SB-1220-14	29 x 24 cm

Dressing/ Sterilizing Drum
in Different Sizes



Code	Size
SB-1221-01	20 x 10 x 5 cm
SB-1221-02	25 x 12 x 5 cm
SB-1221-03	26 x 15 x 5 cm

Boiling Sterilizer with Perforated Tray Stand and Lifter



Code	Size	Code	Size
SB-1222-01	7.5 x 7.5 cm	SB-1223-01	18 x 18 cm
SB-1222-02	10 x 10 cm	SB-1223-02	10 x 12.5 cm
SB-1222-03	12.5 x 12.5 cm	SB-1223-03	20 x 20 cm
SB-1222-04	15 x 18 cm		

Boiling Sterilizer with Perforated Tray Stand and Lifter



Code	Size
SB-1224-01	5 x 11.5 cm
SB-1224-02	5 x 16.5 cm

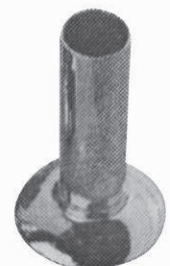

Code	Size
SB-1225-11	3 x 11 cm

Thermometer Jar



SB-1226-01
Ounces
10, 20, 40, 60, 80



SB-1226-02
Ounces
40

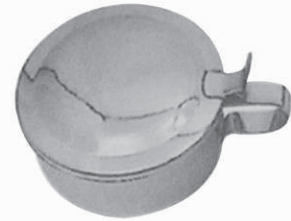

SB-1227-01
Spitten Mug



SB-1228-10 10 cm
SB-1228-12 12 cm
SB-1228-15 15 cm
SB-1228-20 20 cm
SB-1228-25 25 cm
Lotion Bowl



SB-1229-01 50 cc
SB-1229-02 100 cc
Medicine Cup

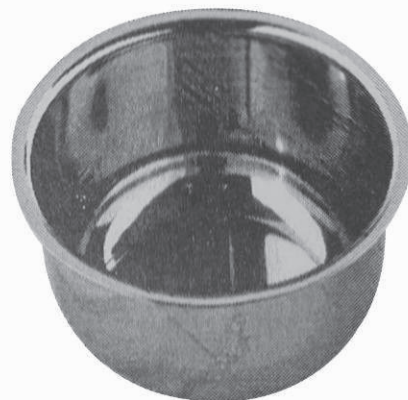

SB-1230-01 80 x 50 mm
Iodine Cup



SB-1231-01
Cotton Wool Holder



Code	Size
SB-1232-01	9.5 x 5.4 x 1 cm
SB-1232-02	15 x 10 x 1 cm
SB-1232-03	18.5 x 10.5 x 1 cm
SB-1232-04	19 x 10x 1.5 cm
SB-1232-05	20 x 10 x 1 cm
SB-1232-06	20 x 15 x 1 cm
SB-1232-07	25 x 15 x 1 cm
SB-1232-08	28 x 19 x 2 cm
SB-1232-09	29 x 19 x 1 cm

Instruments Tray



Code	Size
SB-1233-01	12 cm
SB-1233-02	15 cm
SB-1233-03	20 cm
SB-1233-04	26 cm
SB-1233-05	30 cm

Kidney Tray



SB-1234-01

Upper / Lower Denture Flask & Bench Press
Denture Flask Set featur forged Brass alloy
Construction. Fitted with Hardened stainless steel
alloy Rear Tapered Guide pins. Flask Dimensions:
Long x 3³/₄"Wide x 2¹/₄"High
(10cm x 10cm x 6cm) Unit wweight: 3.850kg including
(upper / Lower Flask & Bench press)



SB-1235-01

Small Denture Flask & Bench Press
Denture Flask Set featur forged Brass alloy
Construction. Fitted with Hardened stainless steel
alloy Rear Tapered Guide pins. Flask Dimensions:
4"Long x 3³/₄"Wide x 2¹/₄"High
(10cm x 10cm x 6cm) Unit wweight: 2.425kg including
(Flask & Bench press)

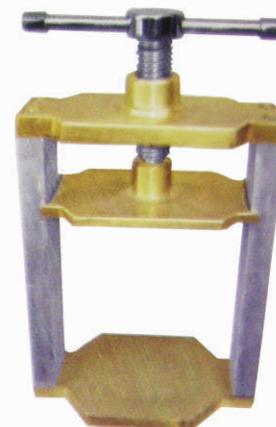

SB-1236-01

Flat Bench Press for 2 Denture
Flasks (upper + lower).
Dimension: 20 x 12.7 x 8cm &
Unit weight is 2.17kg

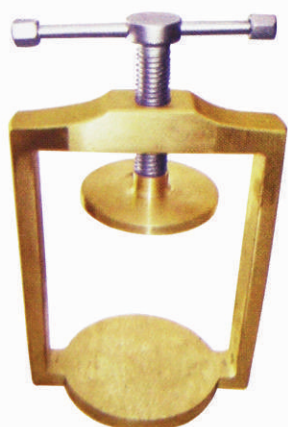

SB-1237-01

Alloy Brass Round Bench Press
for 2 Flask. Dimension: 7"x5"x 3¹/₂"
& Unit Weight 1.900kg

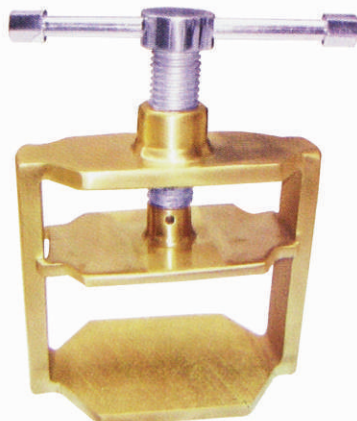

SB-1238-01

Small Denture Bench Press
for single Flask. Brass
Alloy Construction.
Dimension: 5"x 3"x 4³/₄"
& Unit Weight 1.500kg



SB-1239-01

Large Denture Flask &
Bench Press. Alloy Construction
Dimension: Flask Dimension:
5"x 3¹/₂"x 2¹/₂"
& Weight 1.100kg Each
Unit weight 5.750kg
Including (3 Flasks & Bench Press)



SB-1230-01

Large Bench Press for
3 Flasks. Featured forged
Brass Alloy construction.
Dimension: 29 x 14 x 9cm
Unit weight: weight 2.800kg



SB-1241-01
Round Denture Flask
are made in superior
Gunmetal & Brass
The round Flasks are Appropriate
Dimension: 4" x 4 1/2" x 2 1/2" and
Weight 1.100kg



SB-1242-01
Crown Flask for Dental Tooth,
Forged Brass Alloy construction
Unit weight: 365 gram



SB-1243-01
One Side Flat Brass Flask.
New Shape forged brass
Alloy construction.
Dimension: 2 1/4" x 3 1/2" x 4 3/4"
& Unit weight 955 gram



SB-1244-00
Mortimer Silverline Alloy Flask.
Forged Silver Alloy construction.
Dimension: 4 1/4" Long x 4"
Wide x 2 3/4" High (11 x 10 x 7cm)
Unit weight = 750 gram

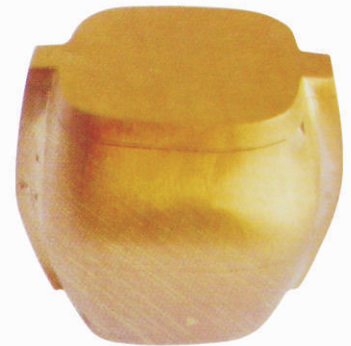

SB-1245-00
Forged Brass Toothed
Dental Alloy Flask for
Single tooth.
Dimension: 5.0 x 5.0 x
4.0cm &
Unit weight 270gram



SB-1246-00
Square Dental Alloy Flask.
Pressure Die Casted, made of brass
Dimension: 7.2 x 8.4 x 5.0 cm
Unit weight 1.300kg



SB-1247-00
Upper Denture Flask forged
Brass Alloy construction. Fitted
with Hardened stainless steel
Alloy rear Tapered guide pin.
Dimension: 4" Long x 3 3/4"
wide x 2 1/4" High (10cm x 10cm x 6cm)
& weight: 0.920kg



SB-1248-00
Lower Denture Flask forged
Brass Alloy construction. Fitted
with Hardened stainless steel
Alloy rear Tapered guide pins.
Dimension: 4" Long x 3 3/4"
wide x 2 1/4" High (10cm x 10cm x 6cm)
& weight: 0.920kg



SB-1249-00

Upper Denture Flask forged Silver Alloy construction. Fitted with Hardened stainless steel Alloy rear Tapered guide pins.
Dimension: 4" Long x 3 3/4" wide x 2 1/4" High (10cm x 10cm x 6cm)



SB-1250-00

Lower Denture Flask forged Silver Alloy construction. Fitted with Hardened stainless steel Alloy rear Tapered guide pins.
Dimension: 4" Long x 3 3/4" wide x 2 1/4" High (10cm x 10cm x 6cm)

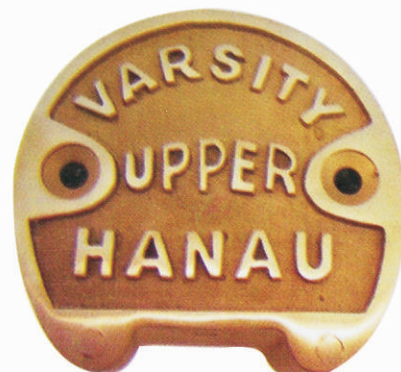

SB-1251-00

Upper / Lower Hanau Denture Flask, forged Brass Alloy Construction. Fitted with Hardened stainless steel Alloy rear Tapered guide pins.
Dimension: 10 x 8 x 16 cm wide x 2 1/4" Long x 3 3/4"



SB-1252-00

Silverline Alloy Flask, forged Silver Alloy construction,
Dimension: 4 1/4" Long x 4" wide x 2 3/4" High (11 x 10 x 7cm)
Unit weight = 760 gram

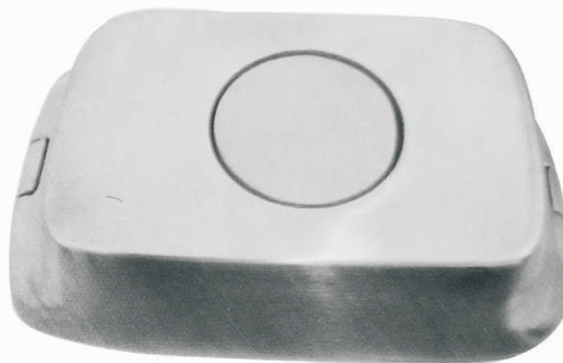

SB-1253-00

Butter Dish Silver Alloy Denture Flask.
Dimension: 10 x 8 x 16 cm
Unit weight = 760 gram



SB-1254-00

Flask Knock-out Disc Forged Brass Alloy construction



SB-1255-00
Dental Forceps Set
Childs



SB-1256-00
Dental Forceps Set



SB-1258-00
Rubber Dam Set



SB-1257-00



CS-1149-00



SB-1260-00
Rubber Dam Set



SB-1261-00
Root Elevator Set



SPEED BIRD ENTERPRISES



161/C, SMALL INDUSTRIAL ESTATE
SIALKOT-51310, (PAKISTAN)



: +92-304 0549944



: +92-52-3555584



: speed@birddent.com



: www.birddent.com